

# TEM

On | Off and everything in between

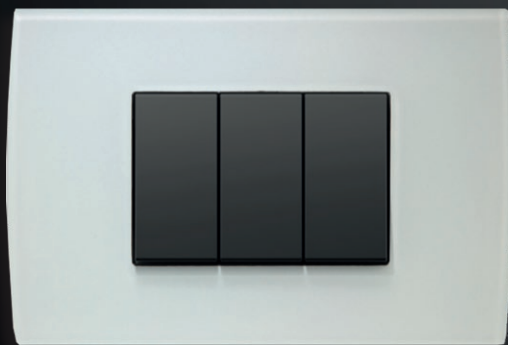

2022



# MODUL



MODUL  
LINE



MODUL  
SOFT



MODUL  
PURE

38

# LOGIQ



146

# ekonomik



176

# fontana



214



# TEM

On | Off and everything in between



Ne jemi prodhuesi kryesor i çelësave dhe i prizave në rajon. Për gjysmë shekulli, u kemi ofruar përdoruesve tanë një përvojë pozitive dhe të lehtë, instalim dhe përdorim të thjeshtë të produkteve, një gamë të gjerë ngjyrash dhe materialesh, të cilat bindin edhe më personat më kërkuës.

*We are the leading manufacturer of switches and sockets in the region. For half a century, we have been providing our users a positive and easy experience, simple installation and use of products, a wide range of colours and materials, which convince even the most demanding.*

# TEM

## Mirë se vini në familjen MODUL

Welcome to the MODUL family

Jepini ambientit tuaj një ndjesi personale dhe tregoni stilin tuaj me çelësat dhe prizat e familjes MODUL.

*Give your ambience a personal touch and show off your style with switches and sockets from MODUL family.*

## zbulojmë ide të reja

discovering new insights



MODUL  

---

LINE



MODUL  

---

SOFT



MODUL  

---

PURE

1

2

MODUL

LINE



MODUL

SOFT



MODUL

PURE



metal

xham

dru



3

4

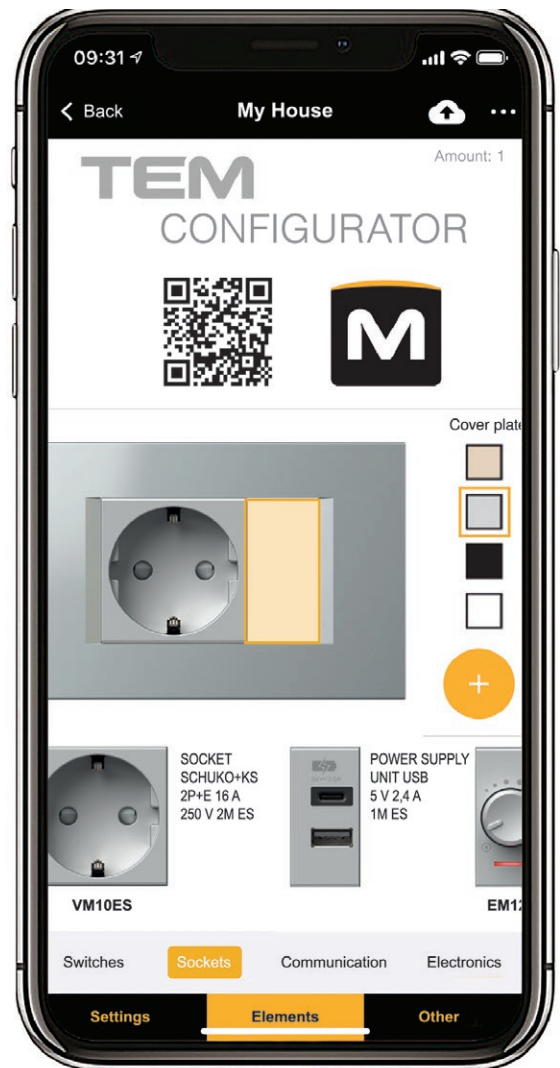

MODUL

---

LINE



Linjat e drejta dhe të lëmuara krijojnë një dizajn klasik.





*Straight, smooth lines create a timeless design.*





MODUL

LINE

PW	IW	ES	AT	SB
				
e bardhë polare	e bardhë fildishi	e argjendë elox	antracit	e zezë soft touch
<i>polar white</i>	<i>ivory white</i>	<i>elox silver</i>	<i>anthracite</i>	<i>soft touch black</i>

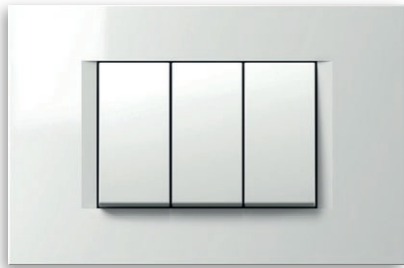

PW e bardhë polare  
*polar white*

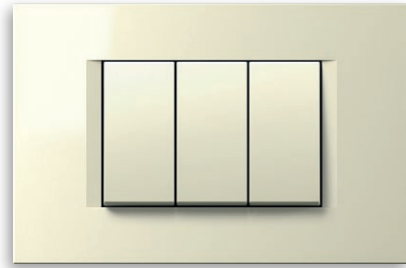

IW e bardhë fildishi  
*ivory white*



SW e bardhë guri  
*stone white*

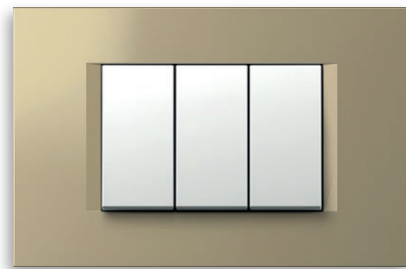

SG e artë ranore  
*sand gold*



ES e argjendtë elox  
*elox silver*

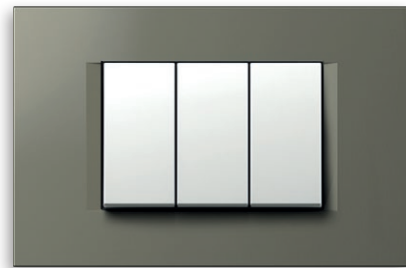

TI titan  
*titanium*

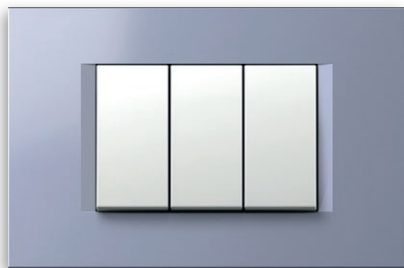

IB blu impulse  
*impulse blue*



AT antracit  
*anthracite*



NB e zezë nate  
*night black*

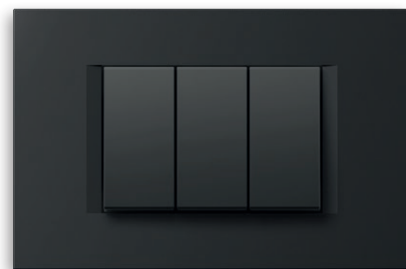

SB e zezë soft touch  
*soft touch black*

MODUL

SOFT

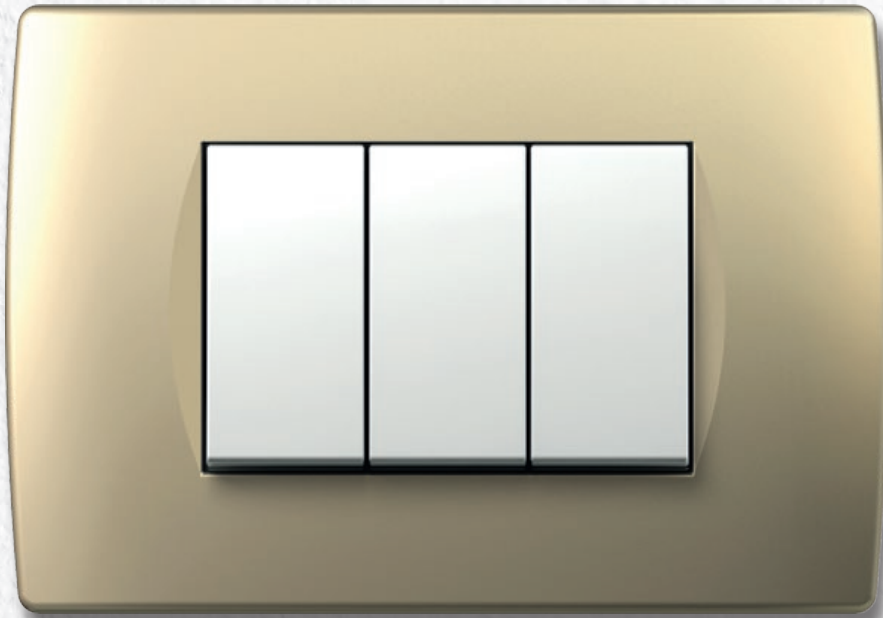

Format e rrumbullakëta dhe pjesët bashkuese të lëmuara sjellin butësi në shtëpinë tuaj.

*Rounded shapes and soft transitions bring softness into your home.*





MODUL

SOFT

PW



e bardhë  
polare

*polar white*

IW



e bardhë  
fildishi

*ivory white*

ES



e argjendë  
elox

*elox silver*

AT



antracit

*anthracite*

SB

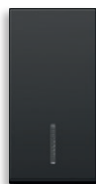

e zezë soft  
touch

*soft touch  
black*



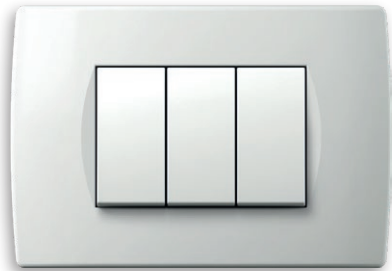

PW e bardhë polare  
*polar white*

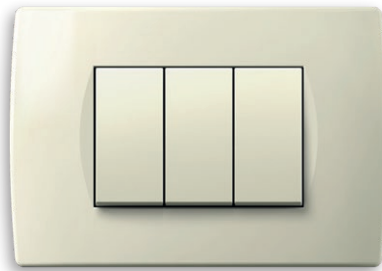

IW e bardhë fildishi  
*ivory white*



ES e argjendtë elox  
*elox silver*

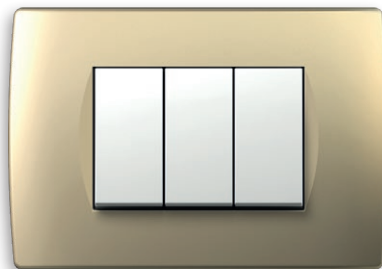

SG e artë ranore  
*sand gold*



WW titan  
*walnut*

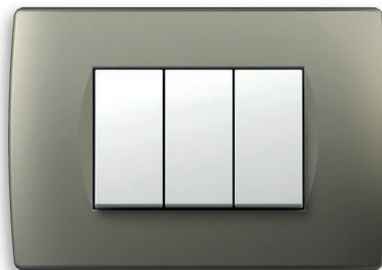

TI titan  
*titanium*



WE venge  
*wenge*

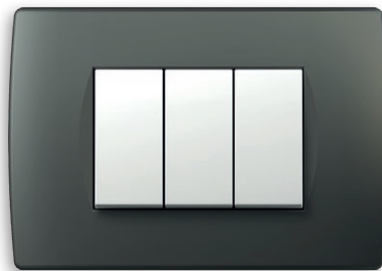

AT antracit  
*anthracite*



NB e zezë nate  
*night black*



SB e zezë soft touch  
*soft touch black*

MODUL

PURE

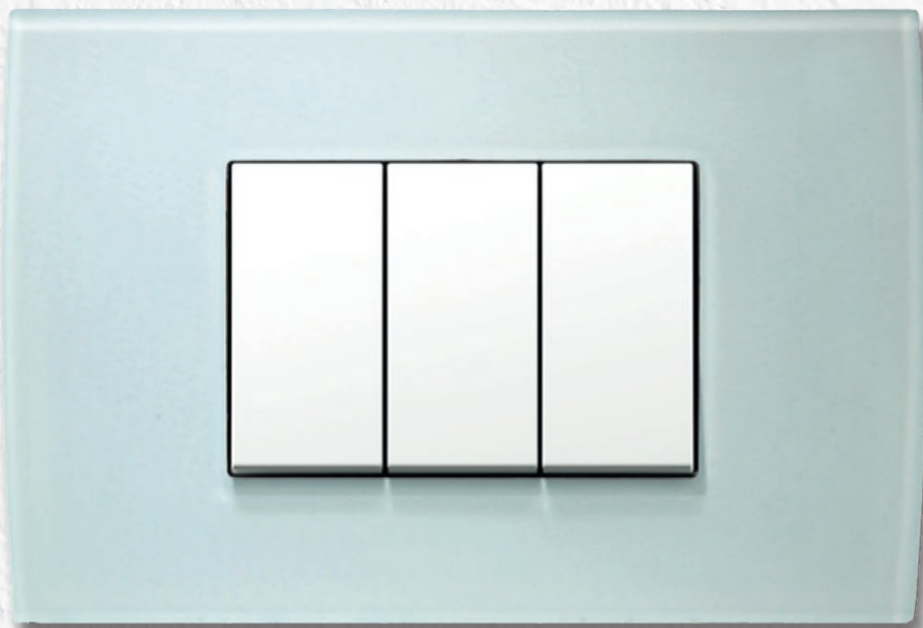

Detajet përfaqësojnë plotësimin e të gjithë ambientit tuaj. Lëreni natyrën të pasurojë hapësirën tuaj me kapakë mbulues dekorativë prej druri, xhami dhe metali.



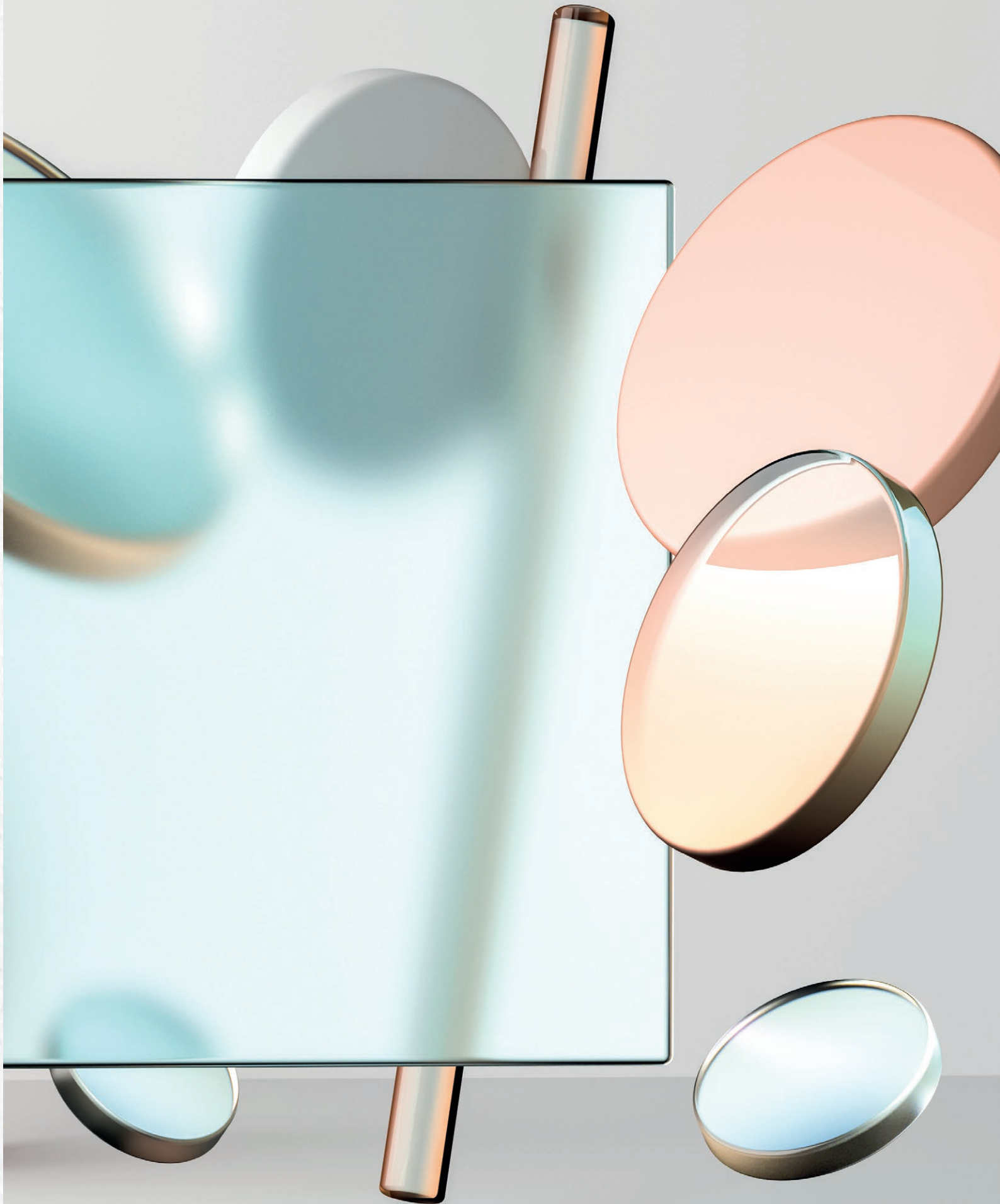

*The details represent the completeness of the entire ambience. Let the nature enrich your space with decorative cover plates made of wood, glass and metal.*





MODUL

PURE

PW	IW	ES	AT	SB
				
e bardhë polare <i>polar white</i>	e bardhë fildishi <i>ivory white</i>	e argjendë elox <i>elox silver</i>	antracit <i>anthracite</i>	e zezë soft touch <i>soft touch black</i>

**xham**  
*glass*



GW e bardhë akulli  
*ice white*

**metal**  
*metal*



MH çelik i farkëtuar  
*hammered steel*

**dru**  
*wood*



WM panjë  
*maple*

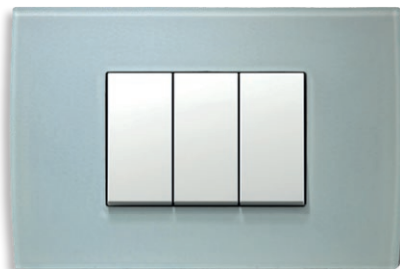

GG e gjelbër akulli  
*ice green*

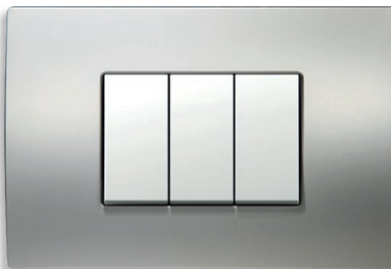

MS argjend satin  
*satin silver*



WB bambu  
*bamboo*

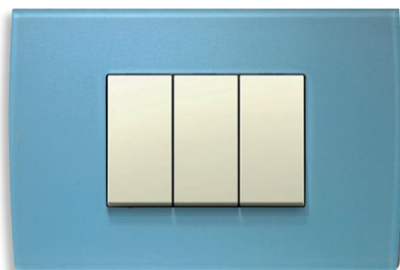

GB blu akulli  
*ice blue*



MN nikel satin  
*satin nickel*



WW arrë  
*walnut*

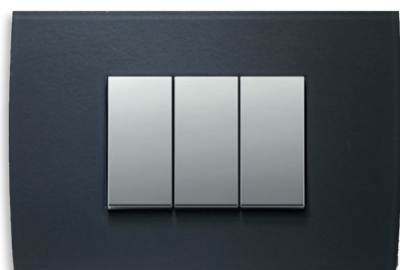

GY gri akulli  
*ice grey*



ME hekur i gdhendur  
*etched iron*



WE venge  
*wenge*

MODUL

PURE



XHAM - i lehtë dhe i sofistikuar.  
Lëreni freskinë të fryjë si fllad nëpër të gjithë shtëpinë  
tuaj.

*GLASS - light and sophisticated.  
Let freshness breeze through your home.*





xham  
glass

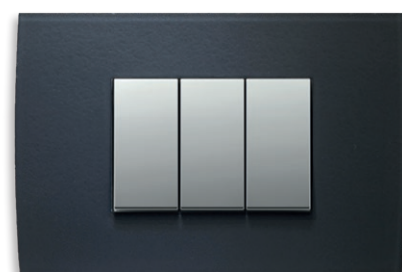
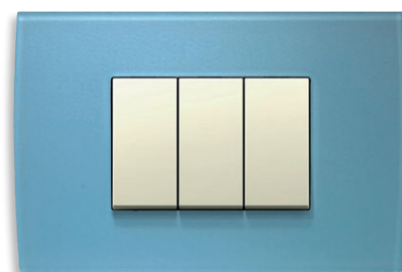
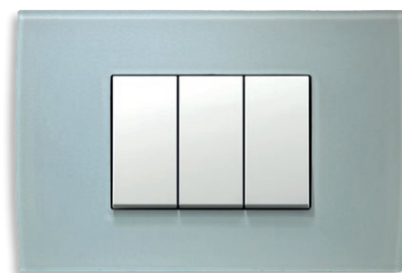

MODUL

PURE



METAL - i ftohtë, por fisnik.  
Përvetësojeni këtë material të dëlirë dhe  
tërhiqni vëmendjen e të tjerëve lehtësisht.

*METAL - cold, yet noble.  
Embrace this pristine material and  
effortlessly catch attention.*







metal  
*metal*

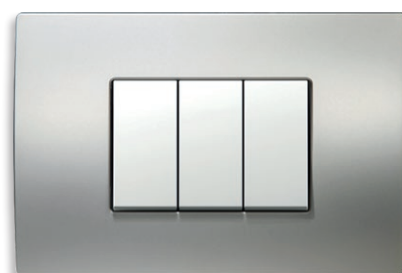

MODUL

PURE



DRURI - i gjithanshëm, por gjithsesi unik.  
Pranoni ngrohtësinë e natyrës.

*WOOD - versatile, yet unique.  
Give way to nature's warmth.*





**dru**  
*wood*



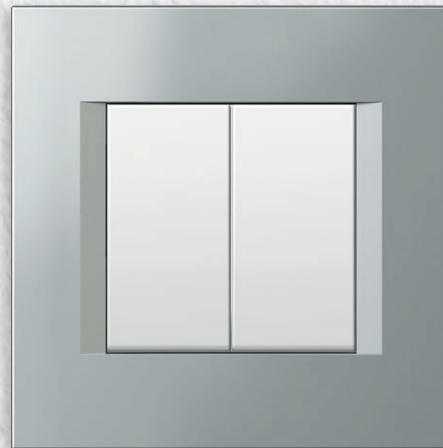



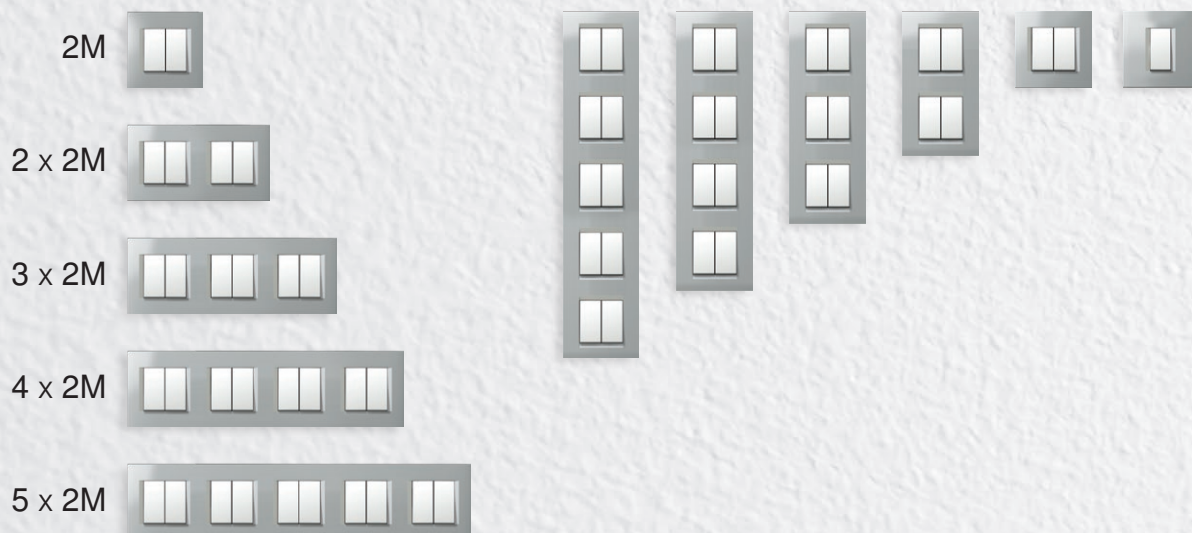
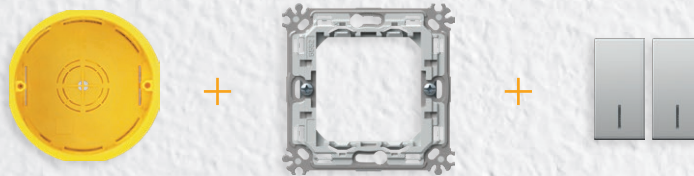

MODUL

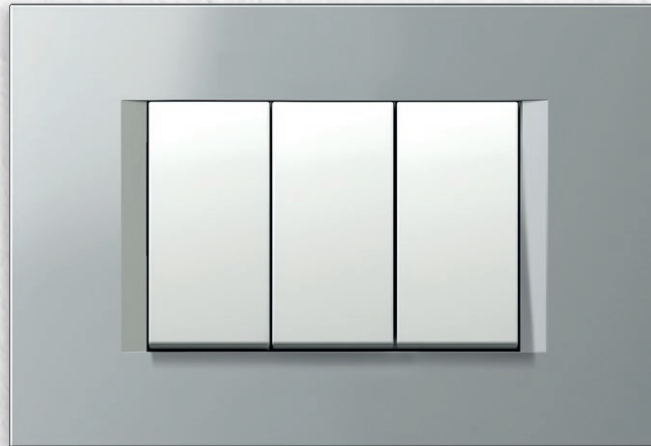
- LINE
- SOFT
- PURE





MODUL

-  LINE
-  SOFT
-  PURE



2 x 7M

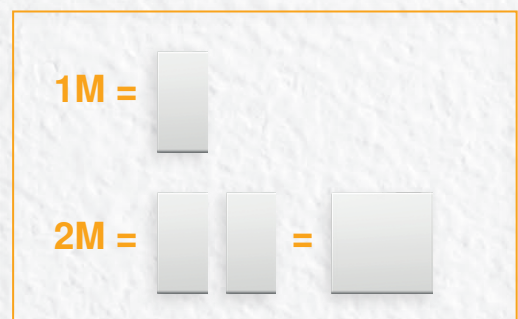

Elementet e funksionit futen lehtë brenda kornizës së montimit. Zgjidhja me “futje dhe nxjerrje në çast” që kemi zhvilluar për ju do t’ju reduktojë kohën e instalimit. Kontaktet e lidhjes arrihen lehtë nga pjesa e përparme.

The function elements are easily fitted inside the mounting frame.

The “klik-in, klik-out” solution we have developed for you will reduce installation time. The connection contacts are easily accessible from the front.

klik-in, klik-out

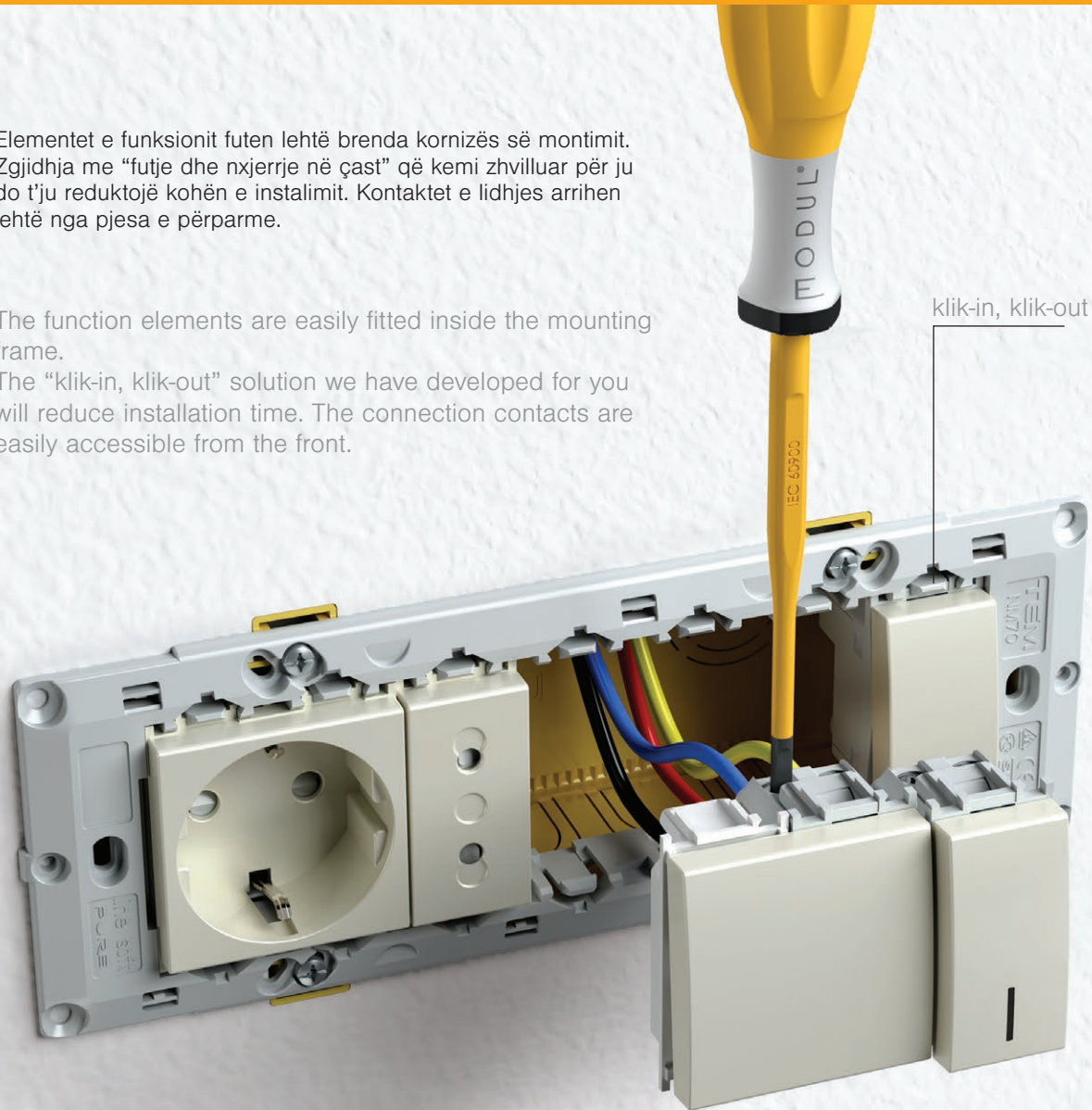

Modul është i përshtatshëm për të gjitha llojet e mureve dhe mund të përdoret në mure me konstruksione tradicionale, boshe ose betoni. Instalohet me lehtësi dhe ju jep mundësinë të kombinoni kutitë drejtkëndore ose të rrumbullakëta në distancat e duhura. Materialet e përdorura janë në pajtim me standardet më të larta.

The Modul is suitable for all wall types and can be used in conventional, hollow wall or concrete constructions. It is easy to install and enables you to combine rectangular or round boxes at the proper distances. The materials used are compliant with high standards.



tullë / brick



mur bosh / hollow wall



beton / concrete

Modul ofron mundësi të shumta edhe me kutitë drejtkëndore. Mund t'i kombinoni horizontalisht ose vertikalisht, individualisht ose në grupe. Korniza metalike e montimit siguron qëndrueshmëri të shkëlqyer edhe me përdorim të shpeshtë dhe është e përshtatshme për çdo kapak mbulues dekorativ.

The Modul enables a many possibilities even with round boxes. You can combine them horizontally or vertically, individually or in groups. The metal mounting frame ensures excellent stability even with rough use and is suitable for any decorative cover plates.

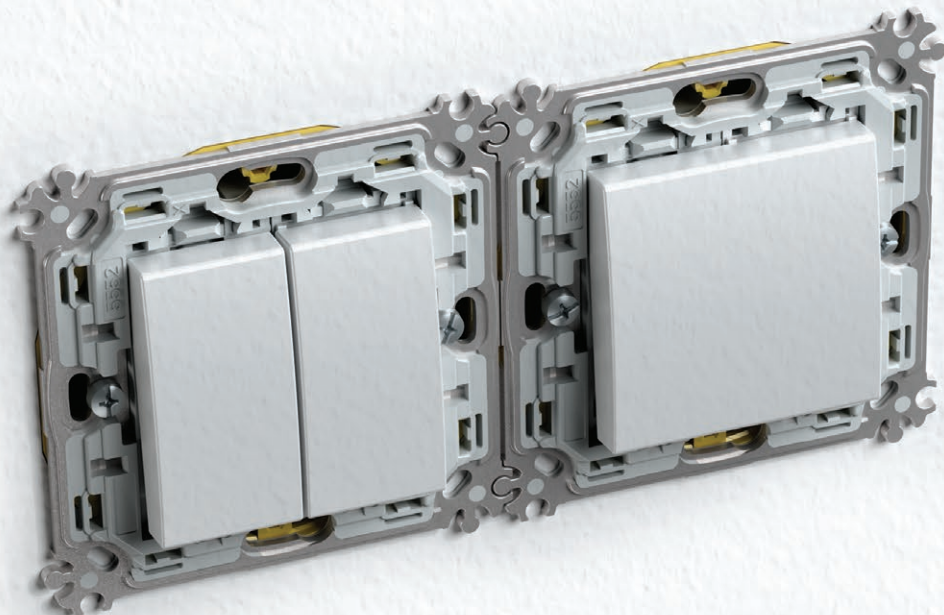



□ PW e bardhë polare  
polar white



■ SB e zezë soft touch  
soft touch black



■ AT antracit  
anthracite



□ ES e argjendtë elox  
elox silver



□ IW e bardhë fildishi  
ivory white



### SIMBOLET SYMBOLS

01	02	03	04	05	06	07	08	09	10	11	12	20	21	22	23
24	25	26	27	28	29	30	31	32	33	34	35	36	37	38	39
					OFF	ON					AC				
40	41	42	43	44	45	46	47	48							

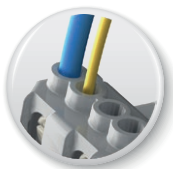
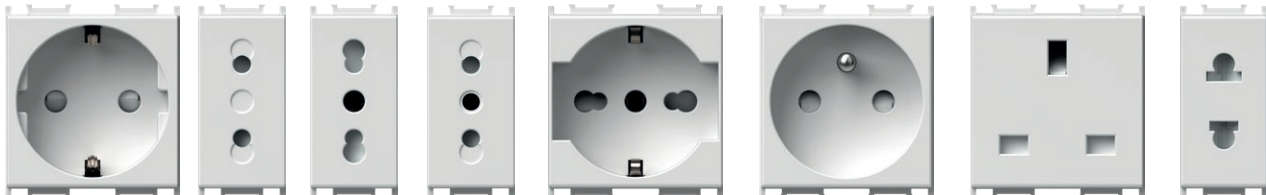

Lidhje e sigurt edhe kur përdoren madhësi të ndryshme telash.  
Reliable connection even when different size of wires are used.



Të gjitha prizat janë të pajisura me mbyllëse sigurie që garantojnë mbrojtjen e kontakteve nën tension.  
All the sockets are equipped with a safety shutters assuring the protection to live contacts.



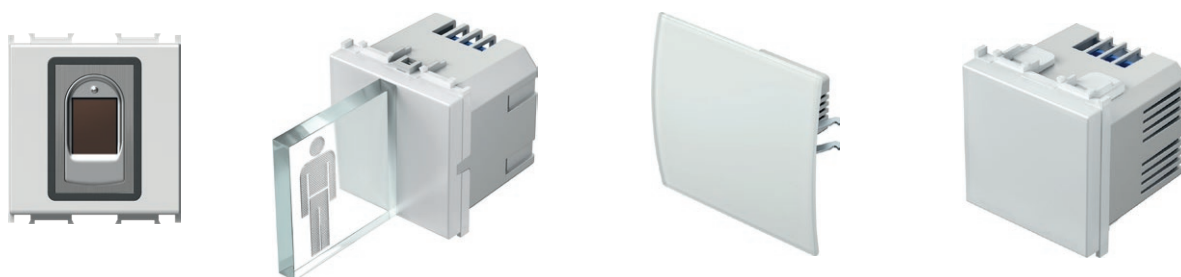
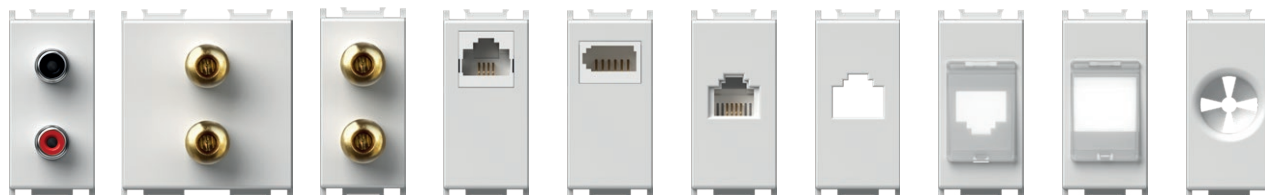

**IEC**  
**40.000**  
çelësat

Jetëgjatësi e çelësave dhe përputhje me standardet ndërkombëtare.

*Long-life of switches and adequacy to the international standards.*

**16 AX**  
kontaktet

Çelësi është shumë i sigurt përmes kontakteve të përçinave prej argjendi.

*The switch is highly reliable via its silver rivets contacts.*





BIOPASS - çelës me gjurmë gishti

*BIOPASS - fingerprint switch*

Shkyçje pa çelës.

*Keyless unlocking.*

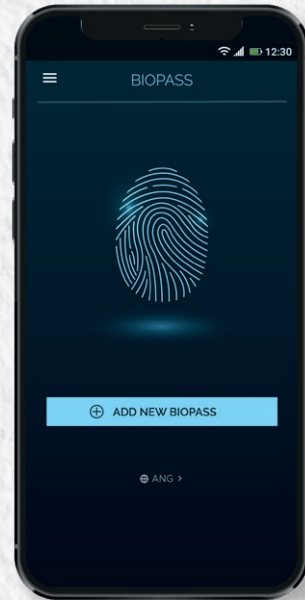

MULTIMEDIA

*MULTIMEDIA*

Qendër multimediale që do ju lejon të lidhni një numër të shumtë komponentësh në një vend.

*Multimedia center that allows you to connect a multiple number of components in one place.*



## TOUCH - reostat universal

*TOUCH - universal dimmer*

Takim-stakim dhe ulje e ndriçimit të llambave të ndryshme

*Switching and dimming of different lamps*

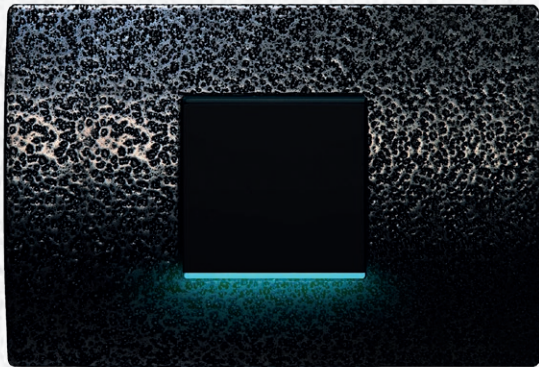

## KRIJONI TUAJIN

*CREATE YOUR OWN*

Kur porositni sasi të mëdha, kapakët mbulues dhe elementet e funksionit mund të bëhen në ngjyrën e dëshiruar.

*When ordering large quantities, cover plates and function elements can be made in the colour of your choice.*



## BËJENI UNIKE

*MAKE IT UNIQUE*

Zgjidhni një ngjyrë ndriçimi dhe shtoni grafikën e dëshiruar që i përshtatet atmosferës së dhomës suaj.

*Choose a illumination colour and add desired graphic to suit the ambience of your room.*



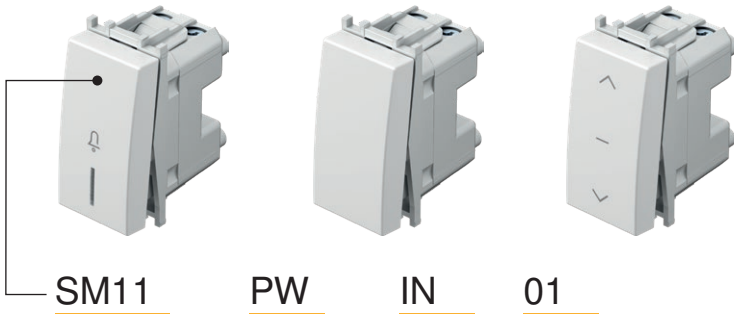

Iloji type	përshkrimi description	të dhënat teknike technical data	madhësia size	ngjyra colour	të dhënat opsionale 1 optional data 1	të dhënat opsionale 2 optional data 2
SM10	ÇELËS ME 1 DREJTIM SWITCH 1WAY	16AX 250V~	1M	<input type="checkbox"/> PW e bardhë polare polar white	<input type="checkbox"/> NT neutral neutral	01
SM11	BUTON MESHTYPJE ME 1 DREJTIM PUSH BUTTON 1WAY	16A 250V~	1M	<input checked="" type="checkbox"/> SB e zezë soft touch soft touch black	<input type="checkbox"/> IN treguesi indicator	02
SM12	ÇELËS ME 1 DREJTIM SWITCH 1WAY	20A 250V~	1M	<input checked="" type="checkbox"/> AT antracit anthracite		03
·	·	·	·	<input type="checkbox"/> ES e argjendtë elox elox silver		
·	·	·	·	<input type="checkbox"/> IW e bardhë fildishi ivory white		

ÇELËS ME 1 DREJTIM 16 A X 250 V~ 1M



SM10

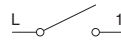

- çelës pa buton
  - 16 A X 250 V~, Iloji SM10
  - në përputhje me EN 60669-1
  - kontaktet e vidave 1,5-2,5 mm<sup>2</sup>
- SWITCH 1WAY 16AX 250V~ 1M**
- switch without button
  - 16AX 250V~, type SM10
  - in accordance with EN 60669-1
  - screw contacts 1.5-2.5mm<sup>2</sup>

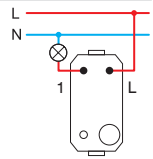

BUTON ME SHTYPJE ME 1 DREJTIM 16 A 250 V~ 1M



SM11



- buton me shtypje pa buton
  - 16 A 250 V~, Iloji SM11
  - në përputhje me EN 60669-1
  - kontaktet e vidave 1,5-2,5 mm<sup>2</sup>
- PUSH BUTTON 1WAY 16A 250V~ 1M**
- push button without button
  - 16A 250V~, type SM11
  - in accordance with EN 60669-1
  - screw contacts 1.5-2.5mm<sup>2</sup>

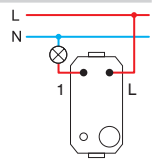

ÇELËS ME 1 DREJTIM 20 A 250 V~ 1M



SM12

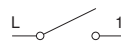

- çelës pa buton
  - 20 A 250 V~, Iloji SM12
  - në përputhje me EN 60669-1
  - kontaktet e vidave 1,5-2,5 mm<sup>2</sup>
- SWITCH 1WAY 20A 250V~ 1M**
- switch without button
  - 20A 250V~, type SM12
  - in accordance with EN 60669-1
  - screw contacts 1.5-2.5mm<sup>2</sup>

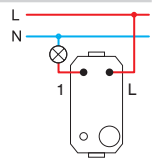

ÇELËS 2 POLAR 16 A X 250 V~ 1M



SM20

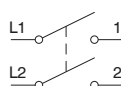

- çelës pa buton
  - 16 A X 250 V~, Iloji SM20
  - në përputhje me EN 60669-1
  - kontaktet e vidave 1,5-2,5 mm<sup>2</sup>
  - vetëm në kombinim me butonin TM15
- SWITCH 2POLE 16AX 250V~ 1M**
- switch without button
  - 16AX 250V~, type SM20
  - in accordance with EN 60669-1
  - screw contacts 1.5-2.5mm<sup>2</sup>
  - only in combination with button TM15

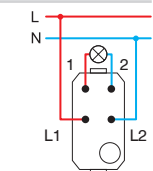

## S W I T C H E S S M



SM40

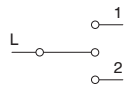

## MBYLLËSE ÇELËSI 1-0-2 16 A X 250 V~ 1M

- çelës pa buton
- 16 A X 250 V~, lloji SM40
- në përputhje me EN 60669-1
- kontaktet e vidave 1,5-2,5 mm<sup>2</sup>

## SWITCH SHUTTERS 1-0-2 16AX 250V~ 1M

- switch without button
- 16AX 250V~, type SM40
- in accordance with EN 60669-1
- screw contacts 1.5-2.5mm<sup>2</sup>

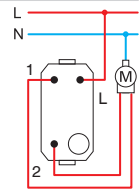

SM41

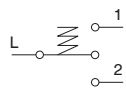

## MBYLLËSE ÇELËSI 1-0-2 16 A X 250 V~ 1M

- buton me shtypje pa buton
- 16 A 250 V~, lloji SM41
- në përputhje me EN 60669-1
- kontaktet e vidave 1,5-2,5 mm<sup>2</sup>

## PUSH BUTTON SHUTTERS 1-0-2 16A 250V~ 1M

- push button without button
- 16A 250V~, type SM41
- in accordance with EN 60669-1
- screw contacts 1.5-2.5mm<sup>2</sup>

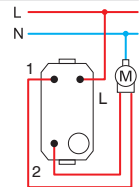

SM60

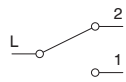

## ÇELËS ME 2 DREJTIME 16 A X 250 V~ 1M

- çelës pa buton
- 16 A X 250 V~, lloji SM60
- në përputhje me EN 60669-1
- kontaktet e vidave 1,5-2,5 mm<sup>2</sup>

## SWITCH 2WAY 16AX 250V~ 1M

- switch without button
- 16AX 250V~, type SM60
- in accordance with EN 60669-1
- screw contacts 1.5-2.5mm<sup>2</sup>

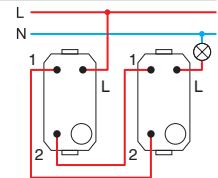

SM61

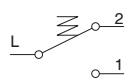

## BUTON ME SHTYPJË ME 2 DREJTIME 16 A 250 V~ 1M

- buton me shtypje pa buton
- 16 A 250 V~, lloji SM61
- në përputhje me EN 60669-1
- kontaktet e vidave 1,5-2,5 mm<sup>2</sup>

## PUSH BUTTON 2WAY 16A 250V~ 1M

- push button without button
- 16A 250V~, type SM61
- in accordance with EN 60669-1
- screw contacts 1.5-2.5mm<sup>2</sup>

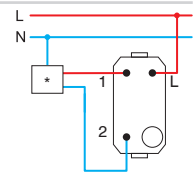

\* lidhjet elektronike / electronics



SM70

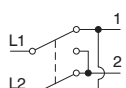

## ÇELËS NDËRMJETËS 16 A X 250 V~ 1M

- çelës pa buton
- 16 A X 250 V~, lloji SM70
- në përputhje me EN 60669-1
- kontaktet e vidave 1,5-2,5 mm<sup>2</sup>

## SWITCH INTERMEDIATE 16AX 250V~ 1M

- switch without button
- 16AX 250V~, type SM70
- in accordance with EN 60669-1
- screw contacts 1.5-2.5mm<sup>2</sup>

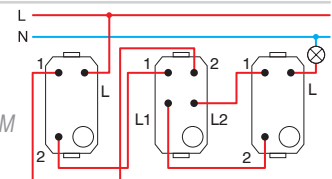

1M = 22,5 x 45  
2M = 45 x 45

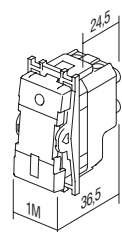
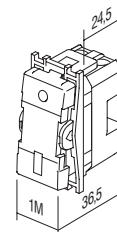



□ PW e bardhë polare  
polar white



■ SB e zezë soft touch  
soft touch black



■ AT antracit  
anthracite



□ ES e argjendtë elox  
elox silver



□ IW e bardhë fildishi  
ivory white

ÇELËS ME 1 DREJTIM 16 A X 250 V~ 1M

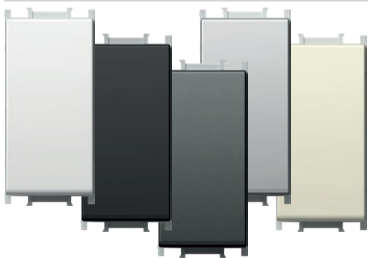

- SM10PW
- SM10SB
- SM10AT
- SM10ES
- SM10IW

- 16 A X 250 V~, Iloji SM10
- në përputhje me EN 60669-1
- kontaktet e vidave 1,5-2,5 mm<sup>2</sup>
- buton i ndërrueshëm

*SWITCH 1WAY 16AX 250V~ 1M*  
- 16AX 250V~, type SM10  
- in accordance with EN 60669-1  
- screw contacts 1.5-2.5 mm<sup>2</sup>  
- replaceable button



ÇELËS ME 1 DREJTIM 16 A X 250 V~ 1M \_\_ IN



- SM10PWIN
- SM10SBIN
- SM10ATIN
- SM10ESIN
- SM10IWIN

- IN tregues
- 16 A X 250 V~, Iloji SM10
- në përputhje me EN 60669-1
- kontaktet e vidave 1,5-2,5 mm<sup>2</sup>
- llamba nuk është e përfshirë
- buton i ndërrueshëm

*SWITCH 1WAY 16AX 250V~ 1M \_\_ IN*  
- IN indicator  
- 16AX 250V~, type SM10  
- in accordance with EN 60669-1  
- screw contacts 1.5-2.5 mm<sup>2</sup>  
- lamp is not included  
- replaceable button



BUTON ME SHTYPJE ME 1 DREJTIM 16 A 250 V~ 1M

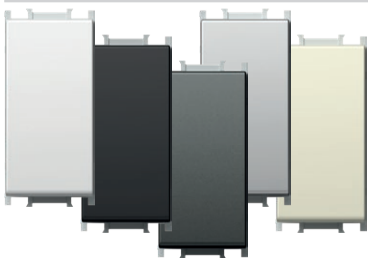

- SM11PW
- SM11SB
- SM11AT
- SM11ES
- SM11IW

- 16 A 250 V~, Iloji SM11
- në përputhje me EN 60669-1
- kontaktet e vidave 1,5-2,5 mm<sup>2</sup>
- buton i ndërrueshëm

*PUSH BUTTON 1WAY 16A 250V~ 1M*  
- 16A 250V~, type SM11  
- in accordance with EN 60669-1  
- screw contacts 1.5-2.5 mm<sup>2</sup>  
- replaceable button



BUTON ME SHTYPJE ME 1 DREJTIM 16 A 250 V~ 1M \_\_ IN 01



- SM11PWIN01
- SM11SBIN01
- SM11ATIN01
- SM11ESIN01
- SM11IWIN01

- IN 01 zile treguese
- 16 A 250 V~, Iloji SM11
- në përputhje me EN 60669-1
- kontaktet e vidave 1,5-2,5 mm<sup>2</sup>
- llamba nuk është e përfshirë
- buton i ndërrueshëm

*PUSH BUTTON 1WAY 16A 250V~ 1M \_\_ IN 01*  
- IN 01 indicator bell  
- 16A 250V~, type SM11  
- in accordance with EN 60669-1  
- screw contacts 1.5-2.5 mm<sup>2</sup>  
- lamp is not included  
- replaceable button





## S W I T C H E S S M

## BUTON ME SHYTPJE ME 1 DREJTIM 16 A 250 V~ 1M \_\_ IN 02



- SM11PWIN02
- SM11SBIN02
- SM11ATIN02
- SM11ESIN02
- SM11IWIN02

- IN 02 dritë treguese
- 16 A 250 V~, lloji SM11
- në përputhje me EN 60669-1
- kontaktet e vidave 1,5-2,5 mm<sup>2</sup>
- llamba nuk është e përfshirë
- buton i ndërrueshëm

## PUSH BUTTON 1WAY 16A 250V~ 1M \_\_ IN 02

- IN 02 indicator light
- 16A 250V~, type SM11
- in accordance with EN 60669-1
- screw contacts 1.5-2.5 mm<sup>2</sup>
- lamp is not included
- replaceable button



## ÇELËS 2 POLAR 16 A X 250 V~ 1M \_\_ NT 03



- SM20PWNT03
- SM20SBNT03
- SM20ATNT03
- SM20ESNT03
- SM20IWNT03

- NT 03 neutral 0-1
- 16 A X 250 V~, lloji SM20
- në përputhje me EN 60669-1
- kontaktet e vidave 1,5-2,5 mm<sup>2</sup>
- buton i ndërrueshëm

## SWITCH 2POLE 16AX 250V~ 1M \_\_ NT 03

- NT 03 neutral 0-1
- 16AX 250V~, type SM20
- in accordance with EN 60669-1
- screw contacts 1.5-2.5 mm<sup>2</sup>
- replaceable button



## ÇELËS 2 POLAR 16 A X 250 V~ 1M \_\_ IN



- SM20PWIN
- SM20SBIN
- SM20ATIN
- SM20ESIN
- SM20IWIN

- IN tregues
- 16 A X 250 V~, lloji SM20
- në përputhje me EN 60669-1
- kontaktet e vidave 1,5-2,5 mm<sup>2</sup>
- llamba nuk është e përfshirë
- buton i ndërrueshëm

## SWITCH 2POLE 16AX 250V~ 1M \_\_ IN

- IN indicator
- 16AX 250V~, type SM20
- in accordance with EN 60669-1
- screw contacts 1.5-2.5 mm<sup>2</sup>
- lamp is not included
- replaceable button



## MBYLLËSE ÇELËSI 1-0-2 16 A X 250 V~ 1M \_\_ NT 10

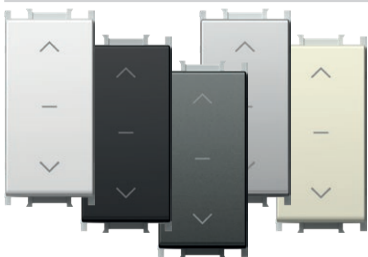

- SM40PWNT10
- SM40SBNT10
- SM40ATNT10
- SM40ESNT10
- SM40IWNT10

- NT 10 neutral 1-0-2
- 16 A X 250 V~, lloji SM40
- në përputhje me EN 60669-1
- kontaktet e vidave 1,5-2,5 mm<sup>2</sup>
- buton i ndërrueshëm

## SWITCH SHUTTERS 1-0-2 16AX 250V~ 1M \_\_ NT 10

- NT 10 neutral 1-0-2
- 16AX 250V~, type SM40
- in accordance with EN 60669-1
- screw contacts 1.5-2.5mm<sup>2</sup>
- replaceable button



## MBYLLËSE BUTONI ME SHYTPJE 1-0-2 16 A 250 V~ 1M \_\_ NT 10

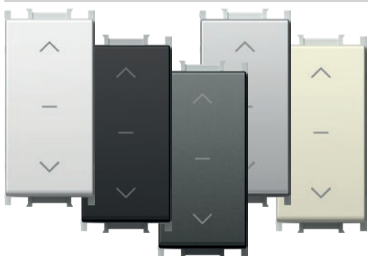

- SM41PWNT10
- SM41SBNT10
- SM41ATNT10
- SM41ESNT10
- SM41IWNT10

- NT 10 neutral 1-0-2
- 16 A 250 V~, lloji SM41
- në përputhje me EN 60669-1
- kontaktet e vidave 1,5-2,5 mm<sup>2</sup>
- buton i ndërrueshëm

## PUSH BUTTON SHUTTERS 1-0-2 16A 250V~ 1M \_\_ NT 10

- NT 10 neutral 1-0-2
- 16A 250V~, type SM41
- in accordance with EN 60669-1
- screw contacts 1.5-2.5mm<sup>2</sup>
- replaceable button



## ÇELËS ME 2 DREJTIME 16 A X 250 V~ 1M

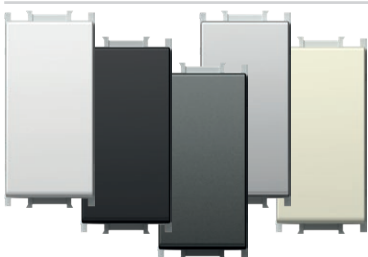

- SM60PW
- SM60SB
- SM60AT
- SM60ES
- SM60IW

- 16 A X 250 V~, lloji SM60
- në përputhje me EN 60669-1
- kontaktet e vidave 1,5-2,5 mm<sup>2</sup>
- buton i ndërrueshëm

## SWITCH 2WAY 16AX 250V~ 1M

- 16AX 250V~, type SM60
- in accordance with EN 60669-1
- screw contacts 1.5-2.5 mm<sup>2</sup>
- replaceable button



BUTON ME SHYTPJE ME 2 DREJTIME 16 A 250 V~ 1M



- SM61PW
- SM61SB
- SM61AT
- SM61ES
- SM61IW

- 16 A 250 V~, Iloji SM61
- në përputhje me EN 60669-1
- kontaktet e vidave 1,5-2,5 mm<sup>2</sup>
- buton i ndërrueshëm

*PUSH BUTTON 2WAY 16A 250V~ 1M*

- 16A 250V~, type SM61
- in accordance with EN 60669-1
- screw contacts 1.5-2.5 mm<sup>2</sup>
- replaceable button



BUTON ME SHYTPJE ME 2 DREJTIME ME KORDON 16 A 250 V~ 1M \_\_ CD



- SM62PWCD
- SM62SBCD
- SM62ATCD
- SM62ESCD
- SM62IWCD

- CD treguesi+kordoni
- gjatësia e kordonit 1.5 m
- 16 A 250 V~, Iloji SM62
- në përputhje me EN 60669-1
- kontaktet e vidave 1,5-2,5 mm<sup>2</sup>

*PUSH BUTTON 2WAY WITH CORD 16A 250V~ 1M \_\_ CD*

- CD indicator+cord
- cord lenght 1.5m
- 16A 250V~, type SM62
- in accordance with EN 60669-1
- screw contacts 1.5-2.5 mm<sup>2</sup>



ÇELËS NDËRMJETËS 16 A X 250 V~ 1M

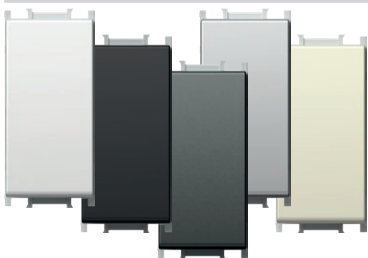

- SM70PW
- SM70SB
- SM70AT
- SM70ES
- SM70IW

- 16 A X 250 V~, Iloji SM70
- në përputhje me EN 60669-1
- kontaktet e vidave 1,5-2,5 mm<sup>2</sup>
- buton i ndërrueshëm

*SWITCH INTERMEDIATE 16AX 250V~ 1M*

- 16AX 250V~, type SM70
- in accordance with EN 60669-1
- screw contacts 1.5-2.5 mm<sup>2</sup>
- replaceable button



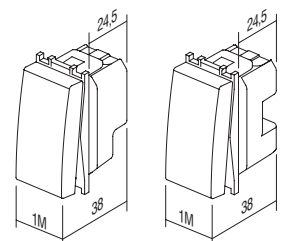

1M = 22,5 x 45  
2M = 45 x 45



## B U T T O N S T M



Iloji type	përshkrimi description	madhësia size	ngjyra colour	të dhënat opsionale 1 optional data 1	të dhënat opsionale 2 optional data 2
TM11	BUTON BUTTON	1M	<input type="checkbox"/> PW e bardhë polare polar white	<input type="checkbox"/> NT neutral neutral	 01
TM12	BUTON BUTTON	2M	<input checked="" type="checkbox"/> SB e zezë soft touch soft touch black	<input type="checkbox"/> IN treguesi indicator	 02
TM21	FALSO BLANK	1M	<input checked="" type="checkbox"/> AT antracit anthracite		 03
:	:	:	<input type="checkbox"/> ES e argjendtë elox elox silver		
:	:	:	<input type="checkbox"/> IW e bardhë fildishi ivory white		

## BUTON 1M



- TM11PW
- TM11SB
- TM11AT
- TM11ES
- TM11IW

- buton i ndërrueshëm 1M  
- në përputhje me EN 60669-1

## BUTON 1M

- replaceable button 1M  
- in accordance with EN 60669-1



## TREGUES BUTONI 1M



- TM11PWIN
- TM11SBIN
- TM11ATIN
- TM11ESIN
- TM11IWIN

- buton i ndërrueshëm 1M  
- në përputhje me EN 60669-1

## BUTON 1M INDICATOR

- replaceable button 1M  
- in accordance with EN 60669-1



## BUTON 2M

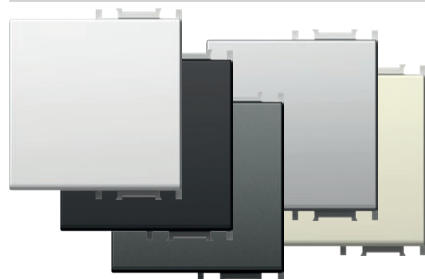

- TM12PW
- TM12SB
- TM12AT
- TM12ES
- TM12IW

- buton i ndërrueshëm 2M me mbajtëse butoni  
- për të përditësuar çelësin ose butonin me shtypje  
nga madhësia 1M në madhësinë 2M  
- në përputhje me EN 60669-1

## BUTON 2M

- replaceable button 2M with button carrier  
- to upgrade switch or push button  
from size 1M to size 2M  
- in accordance with EN 60669-1



## TREGUES BUTONI 2M

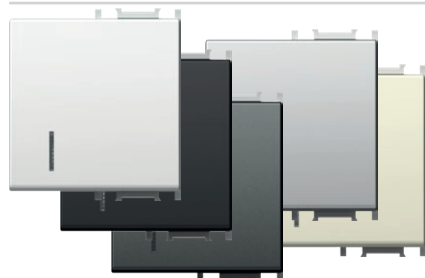

- TM12PWIN
- TM12SBIN
- TM12ATIN
- TM12ESIN
- TM12IWIN

- buton i ndërrueshëm 2M me mbajtëse butoni  
- për të përditësuar çelësin ose butonin me shtypje  
nga madhësia 1M në madhësinë 2M  
- në përputhje me EN 60669-1

## BUTON 2M INDICATOR

- replaceable button 2M with button carrier  
- to upgrade switch or push button  
from size 1M to size 2M  
- in accordance with EN 60669-1



**BUTON 2M ME KAPAK ME MBISHKRIM**

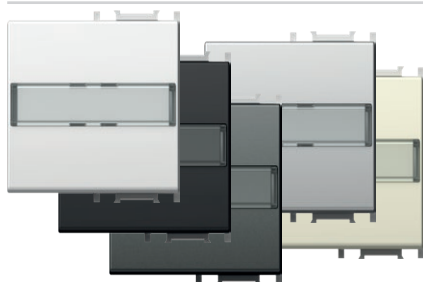

- TM13PWIL
- TM13SBIL
- TM13ATIL
- TM13ESIL
- TM13IWIL

- buton i ndërrueshëm 2M me mbajtëse butoni  
 - për të përditësuar çelësin ose butonin me shtypje nga madhësia 1M në madhësinë 2M  
 - në përputhje me EN 60669-1

*BUTTON 2M WITH INSCRIPTION PLATE*  
 - replaceable button 2M with button carrier  
 - to upgrade switch or push button from size 1M to size 2M  
 - in accordance with EN 60669-1



**BUTON 1M 2 POLAR**

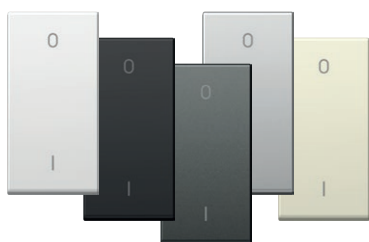

- TM15PW
- TM15SB
- TM15AT
- TM15ES
- TM15IW

- buton i ndërrueshëm 1M  
 - vetëm në kombinim me mekanizmin SM20  
 - në përputhje me EN 60669-1

*BUTTON 1M 2POLE*  
 - replaceable button 1M  
 - only in combination with mechanism SM20  
 - in accordance with EN 60669-1



**FALSO 1M**

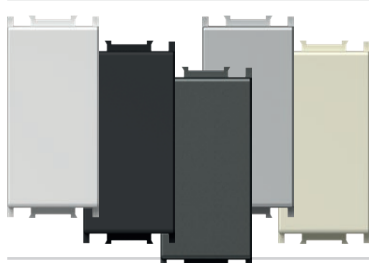

- TM21PW
- TM21SB
- TM21AT
- TM21ES
- TM21IW

- modul falso për të mbushur hapësirat boshe  
 - në përputhje me EN 60669-1

*BLANK 1M*  
 - blank modul to fill up empty spaces  
 - in accordance with EN 60669-1



**FALSO 2M**



- TM22PW
- TM22SB
- TM22AT
- TM22ES
- TM22IW

- modul falso për të mbushur hapësirat boshe  
 - në përputhje me EN 60669-1

*BLANK 2M*  
 - blank modul to fill up empty spaces  
 - in accordance with EN 60669-1



**DALJE PËR KABLO 1M**

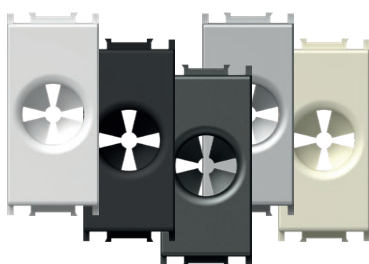

- TM31PW
- TM31SB
- TM31AT
- TM31ES
- TM31IW

- dalje për kablo  
 - në përputhje me EN-60669-1

*CABLE OUTLET 1M*  
 - outlet for cable  
 - in accordance with EN-60669-1



1M = 22,5 x 45  
 2M = 45 x 45

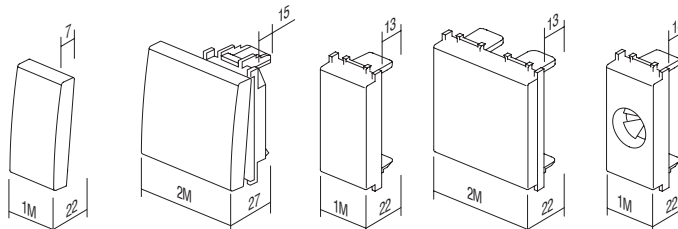

TM11  
TM15

TM12  
TM13

TM21

TM22

TM31

B U T T O N S T M

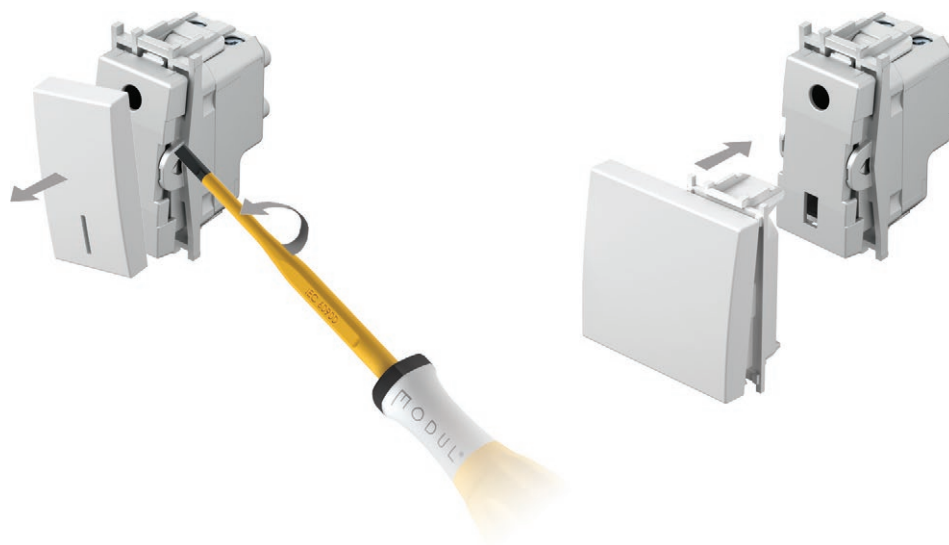

PRINTIM ME LAZER MBI BUTONA

- printim me lazer i çdo lloj grafike në vendet e shënuara
- simbole standarde nga stoku, të tjerat sipas kërkesës

LASER PRINT ON BUTTONS

- laser print of any graphics on marked locations
- standard symbols from stock, other on request

1M

A
B
C

2M

A	D	G
B	E	H
C	F	I

SIMBOLET

SYMBOLS

01	02	03	04	05	06	07	08	09	10	11	12	20	21	22	23
24	25	26	27	28	29	30	31	32	33	34	35	36	37	38	39
					OFF	ON					AC				
40	41	42	43	44	45	46	47	48							

SIMBOLET STANDARDE

STANDARD SYMBOLS

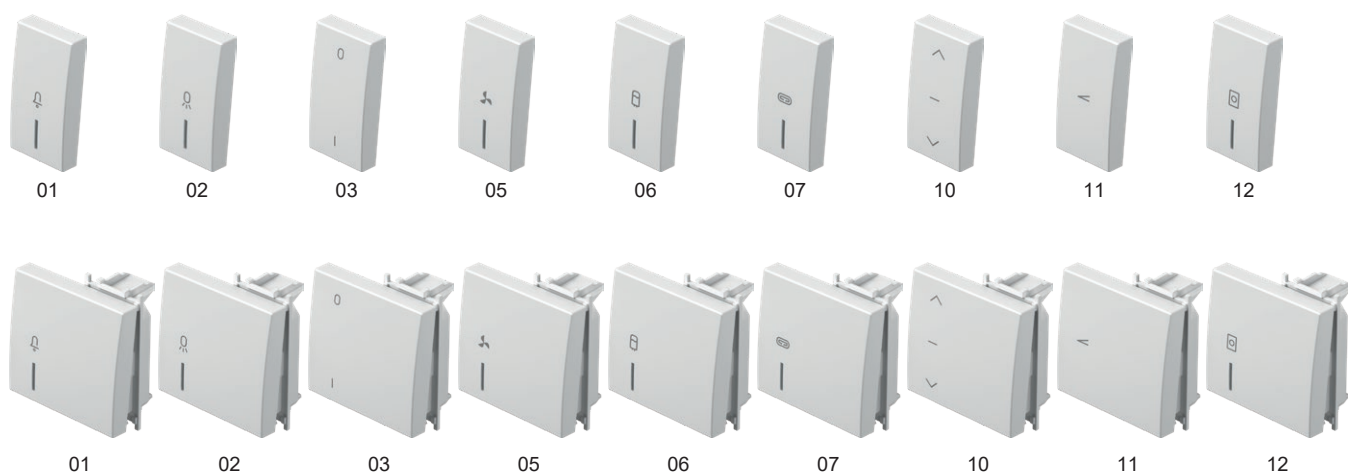

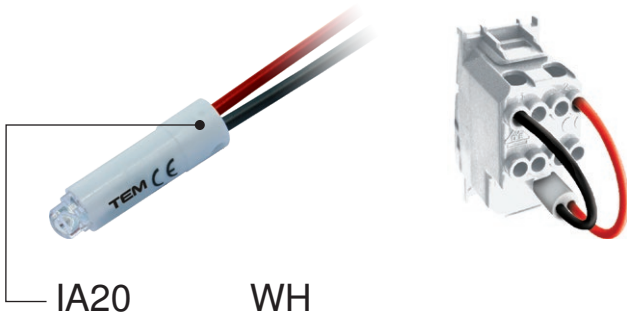

Iloji type	përshkrimi description	të dhënat teknike technical data	ngjyra colour
IA10	LLAMBË NEONI NEON LAMP	230V~ 0,34W	<input type="checkbox"/> WH e bardhë white
IA20	LLAMBË LED LED LAMP	230V~ AC/DC 0,40W	<input checked="" type="checkbox"/> BL blu blue
IA21	LLAMBË LED LED LAMP	24V AC/DC 0,20W	<input checked="" type="checkbox"/> RD e kuqe red
·	·	·	<input checked="" type="checkbox"/> GR e gjelbër green
·	·	·	<input checked="" type="checkbox"/> OR portokalli orange

LLAMBË NEONI 230 V~ 0,34 W

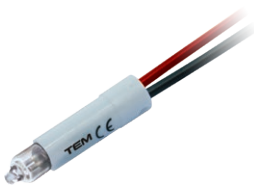

IA10OR

- si tregues, për ndriçim ose ndriçim konstant të çelësit
- në kombinim me butonin me tregues

NEON LAMP 230V~ 0,34W

- for indication, illumination or constant illumination of switch
- in combination with button with indicator

LLAMBË LED 230 V AC/DC 0,40 W



- IA20WH
- IA20GR
- IA20RD
- IA20BL

- si tregues, për ndriçim ose ndriçim konstant të çelësit
- në kombinim me butonin me tregues

LED LAMP 230V AC/DC 0,40W

- for indication, illumination or constant illumination of switch
- in combination with button with indicator

LLAMBË LED 24V AC/DC 0,20W

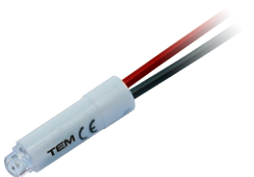

- IA21WH
- IA21RD

- si tregues, për ndriçim ose ndriçim konstant të çelësit
- në kombinim me butonin me tregues

LED LAMP 24V AC/DC 0,20W

- for indication, illumination or constant illumination of switch
- in combination with button with indicator

LLAMBË LED 12V AC/DC 0,10W

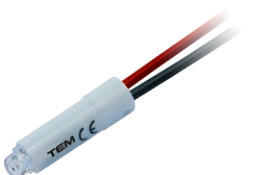

- IA22WH
- IA22RD

- si tregues, për ndriçim ose ndriçim konstant të çelësit
- në kombinim me butonin me tregues

LED LAMP 12V AC/DC 0,10W

- for indication, illumination or constant illumination of switch
- in combination with button with indicator

QARK RC 250 V~



IA50

- qark RC për të eliminuar ndërhyrjet në funksionim të llambave LED
- lidhje paralele me më shumë qarqe RC dhe llamba janë të mundshme
- 0,1 µF, 100 Ω, 250V~

RC CIRCUIT 250V~

- RC circuit to eliminate disturbances in the operation of LED lamps
- parallel connections of more RC circuits with lamps are possible
- 0,1 µF, 100 Ω, 250V~

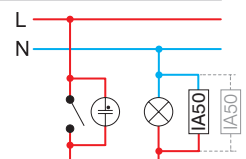

Treguesi /  
Indication

\* Ndrëimi /  
Illumination

Ndrëim konstant /  
Constant illumination

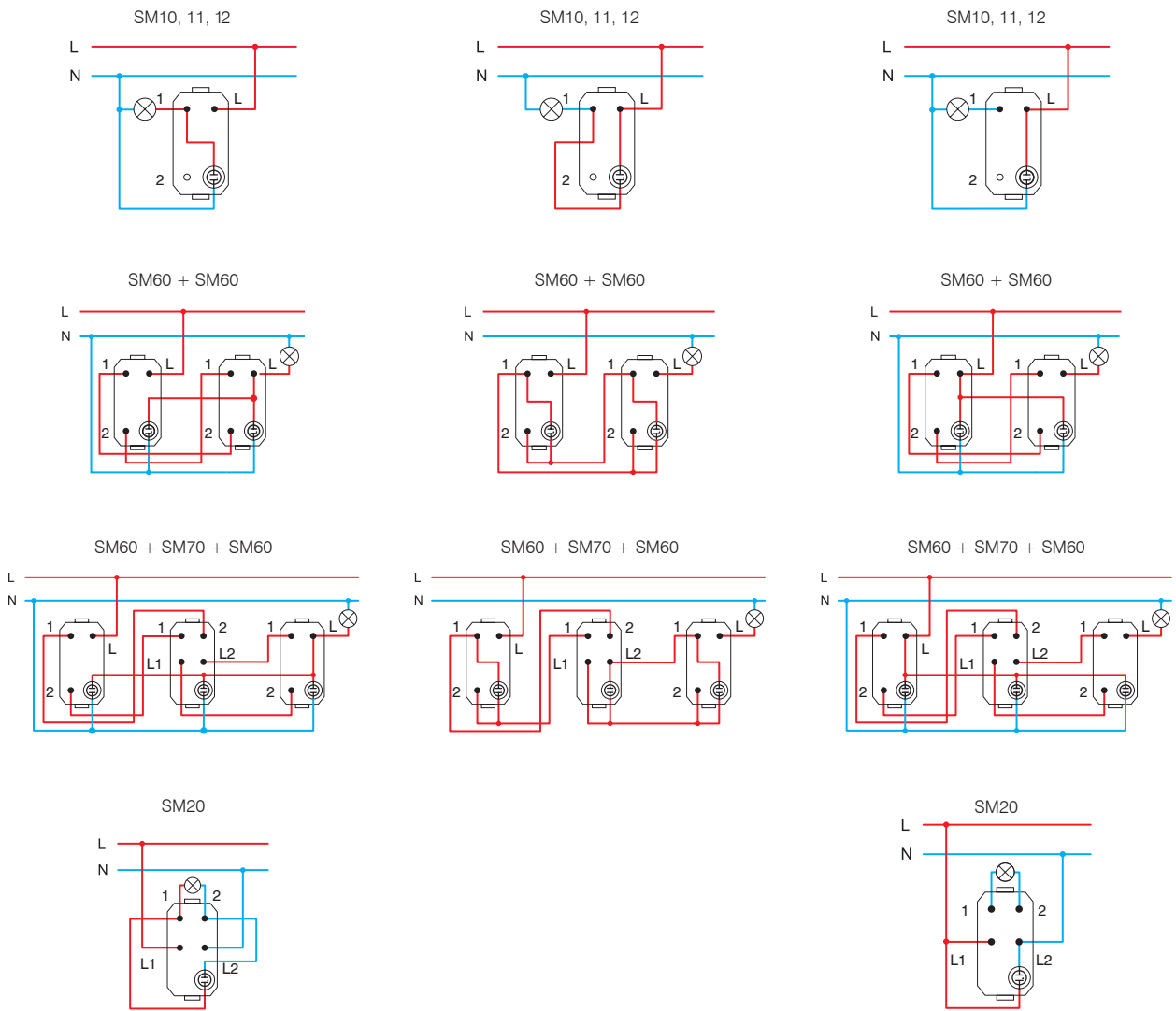

\* lidhjet nuk janë të përshtatshme për llambat që kursajnë energji (CFL, LED) /  
the connections are not suitable for energy-saving bulbs (CFL, LED)

1M = 22,5 x 45  
2M = 45 x 45

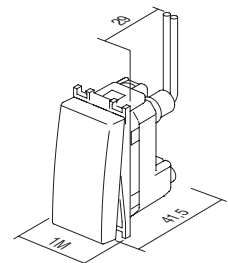

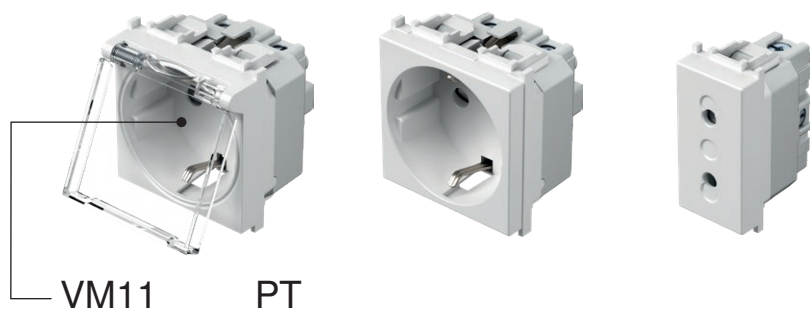

lloji type	përshkrimi description	të dhënat teknike technical data	madhësia size	ngjyra colour																		
VM10	PRIZË SCHUKO+KS SOCKET SCHUKO+KS	2P+E 16A 250V~	2M	<table border="0"> <tr> <td> PW e bardhë polare polar white</td> <td> PT e bardhë+transparente white+transparent</td> <td> PP e bardhë+e bardhë white+white</td> </tr> </table>	PW e bardhë polare polar white	PT e bardhë+transparente white+transparent	PP e bardhë+e bardhë white+white															
PW e bardhë polare polar white	PT e bardhë+transparente white+transparent	PP e bardhë+e bardhë white+white																				
VM11	PRIZË SCHUKO+KS+KAPAK SOCKET SCHUKO+KS+COVER	2P+E 16A 250V~	2M	<table border="0"> <tr> <td> SB e zezë soft touch soft touch black</td> <td> BT e zezë+transparente soft touch black+transparent</td> <td> BB e zezë+e zezë soft touch black+black</td> </tr> </table>	SB e zezë soft touch soft touch black	BT e zezë+transparente soft touch black+transparent	BB e zezë+e zezë soft touch black+black															
SB e zezë soft touch soft touch black	BT e zezë+transparente soft touch black+transparent	BB e zezë+e zezë soft touch black+black																				
VM20	PRIZË EURO+KS SOCKET EURO+KS	2P 10A 250V~	1M	<table border="0"> <tr> <td> AT antracit anthracite</td> <td> AT antracit+transparente anthracite+transparent</td> <td> AA antracit+antracit anthracite+anthracite</td> </tr> <tr> <td> ES e argjendë elox elox silver</td> <td> ST e argjendë+transparente silver+transparent</td> <td> SS e argjendë+e argjendë silver+silver</td> </tr> <tr> <td> IW e bardhë fildishi ivory white</td> <td> IT e fildishtë+transparente ivory+transparent</td> <td> II e fildishtë+e fildishtë ivory+ivory</td> </tr> <tr> <td> RD e kuqe red</td> <td> RT e kuqe+transparente red+transparent</td> <td> RR e kuqe+e kuqe red+red</td> </tr> <tr> <td> GR e gjelbër green</td> <td> GT e gjelbër+transparente green+transparent</td> <td> GG e gjelbër+e gjelbër green+green</td> </tr> <tr> <td> OR portokalli orange</td> <td> OT portokalli+transparente orange+transparent</td> <td> OO portokalli+portokalli orange+orange</td> </tr> </table>	AT antracit anthracite	AT antracit+transparente anthracite+transparent	AA antracit+antracit anthracite+anthracite	ES e argjendë elox elox silver	ST e argjendë+transparente silver+transparent	SS e argjendë+e argjendë silver+silver	IW e bardhë fildishi ivory white	IT e fildishtë+transparente ivory+transparent	II e fildishtë+e fildishtë ivory+ivory	RD e kuqe red	RT e kuqe+transparente red+transparent	RR e kuqe+e kuqe red+red	GR e gjelbër green	GT e gjelbër+transparente green+transparent	GG e gjelbër+e gjelbër green+green	OR portokalli orange	OT portokalli+transparente orange+transparent	OO portokalli+portokalli orange+orange
AT antracit anthracite	AT antracit+transparente anthracite+transparent	AA antracit+antracit anthracite+anthracite																				
ES e argjendë elox elox silver	ST e argjendë+transparente silver+transparent	SS e argjendë+e argjendë silver+silver																				
IW e bardhë fildishi ivory white	IT e fildishtë+transparente ivory+transparent	II e fildishtë+e fildishtë ivory+ivory																				
RD e kuqe red	RT e kuqe+transparente red+transparent	RR e kuqe+e kuqe red+red																				
GR e gjelbër green	GT e gjelbër+transparente green+transparent	GG e gjelbër+e gjelbër green+green																				
OR portokalli orange	OT portokalli+transparente orange+transparent	OO portokalli+portokalli orange+orange																				



PRIZË SCHUKO+KS 2P+E 16 A 250 V~ 2M

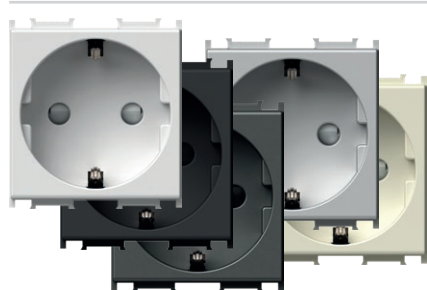

- VM10PW
- VM10SB
- VM10AT
- VM10ES
- VM10IW

- 2P+E schuko
- 16 A 250 V~, lloji VM10
- në përputhje me IEC 60884-1, CEE7
- kontaktet e vidave 1,5-2,5 mm<sup>2</sup>
- kontaktet me rrymën të mbuluara



SOCKET SCHUKO+KS 2P+E 16A 250V~ 2M

- 2P+E schuko
- 16A 250V~, type VM10
- in accordance with IEC 60884-1, CEE7
- screw contacts 1.5-2.5 mm<sup>2</sup>
- shuttered live contacts

PRIZË SCHUKO+KS 2P+E 16 A 250 V~ 2M

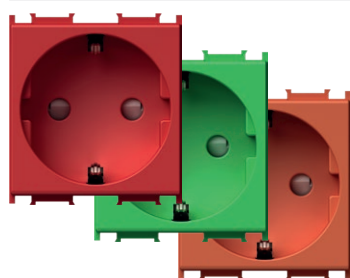

- VM10RD
- VM10GR
- VM10OR

- 2P+E schuko
- 16 A 250 V~, lloji VM10
- në përputhje me IEC 60884-1, CEE7
- kontaktet e vidave 1,5-2,5 mm<sup>2</sup>
- kontaktet me rrymën të mbuluara



SOCKET SCHUKO+KS 2P+E 16A 250V~ 2M

- 2P+E schuko
- 16A 250V~, type VM10
- in accordance with IEC 60884-1, CEE7
- screw contacts 1.5-2.5 mm<sup>2</sup>
- shuttered live contacts

PRIZË SCHUKO+KS+KAPAK 2P+E 16 A 250 V~ 2M

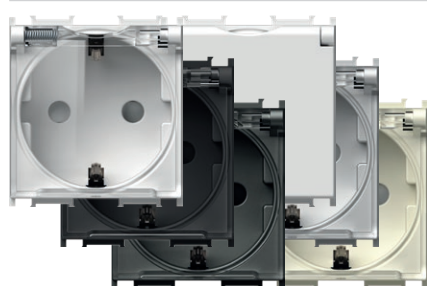

- VM11PT
- VM11BT
- VM11AT
- VM11ST
- VM11IT
- VM11PP

- 2P+E schuko+kapak
- 16 A 250 V~, lloji VM11
- në përputhje me IEC 60884-1, CEE7
- kontaktet e vidave 1,5-2,5 mm<sup>2</sup>
- kontaktet me rrymën të mbuluara



SOCKET SCHUKO+KS+COVER 2P+E 16A 250V~ 2M

- 2P+E schuko+cover
- 16A 250V~, type VM11
- in accordance with IEC 60884-1, CEE7
- screw contacts 1.5-2.5 mm<sup>2</sup>
- shuttered live contacts



## S O C K E T S V M

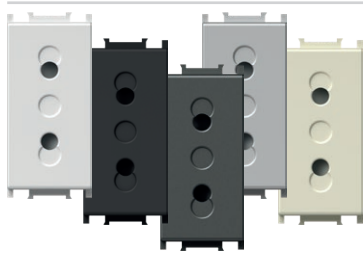

- VM20PW
- VM20SB
- VM20AT
- VM20ES
- VM20IW

## PRIZË EURO+KS 2P 10A 250 V~ 1M

- 2P Euro
- 10A 250 V~, lloji VM20
- në përputhje me IEC 60884-1, CEE7
- kontaktet e vidave 1,5-2,5 mm<sup>2</sup>
- kontaktet me rrymën të mbuluara



## SOCKET EURO+KS 2P 10A 250V~ 1M

- 2P Euro
- 10A 250V~, type VM20
- in accordance with IEC 60884-1, CEE7
- screw contacts 1.5-2.5 mm<sup>2</sup>
- shuttered live contacts

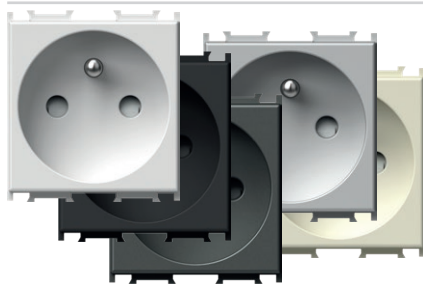

- VM40PW
- VM40SB
- VM40AT
- VM40ES
- VM40IW

## PRIZË FRANCEZE+KS 2P+E 16 A 250 V~ 2M

- 2P+E Franceze
- 16 A 250 V~, lloji VM40
- në përputhje me IEC 60884-1, NF C 61-314, CEE7
- kontaktet e vidave 1,5-2,5 mm<sup>2</sup>
- kontaktet me rrymën të mbuluara



## SOCKET FRENCH+KS 2P+E 16A 250V~ 2M

- 2P+E French
- 16A 250V~, type VM40
- in accordance with IEC 60884-1, NF C 61-314, CEE7
- screw contacts 1.5-2.5 mm<sup>2</sup>
- shuttered live contacts

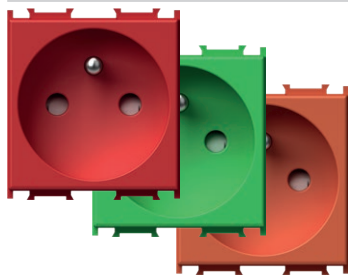

- VM40RD
- VM40GR
- VM40OR

## PRIZË FRANCEZE+KS 2P+E 16 A 250 V~ 2M

- 2P+E Franceze
- 16 A 250 V~, lloji VM40
- në përputhje me IEC 60884-1, NF C 61-314, CEE7
- kontaktet e vidave 1,5-2,5 mm<sup>2</sup>
- kontaktet me rrymën të mbuluara



## SOCKET FRENCH+KS 2P+E 16A 250V~ 2M

- 2P+E French
- 16A 250V~, type VM40
- in accordance with IEC 60884-1, NF C 61-314, CEE7
- screw contacts 1.5-2.5 mm<sup>2</sup>
- shuttered live contacts



- VM41PT
- VM41BT
- VM41AT
- VM41PP
- VM41ST
- VM41IT

## PRIZË FRANCEZE+KS+KAPAK 2P+E 16 A 250 V~ 2M

- 2P+E Franceze+kapak
- 16 A 250 V~, lloji VM41
- në përputhje me IEC 60884-1, NF C 61-314, CEE7
- kontaktet e vidave 1,5-2,5 mm<sup>2</sup>
- kontaktet me rrymën të mbuluara



## SOCKET FRENCH+KS+COVER

- 2P+E 16A 250V~ 2M
- 2P+E French+cover
- 16A 250V~, type VM41
- in accordance with IEC 60884-1, NF C 61-314, CEE7
- screw contacts 1.5-2.5 mm<sup>2</sup>
- shuttered live contacts

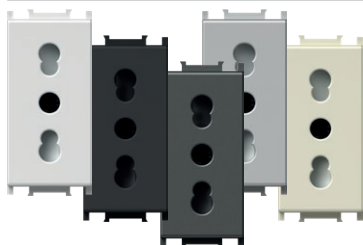

- VM30PW
- VM30SB
- VM30AT
- VM30ES
- VM30IW

## PRIZË ITALIANE P17/11+KS 2P+E 16 A 250 V~ 1M

- 2P+E Italiane P17/11
- 16 A 250 V~, lloji VM30
- në përputhje me IEC 60884-1, CEI 23-50
- kontaktet e vidave 1,5-2,5 mm<sup>2</sup>
- kontaktet me rrymën të mbuluara



## SOCKET ITALIAN P17/11+KS 2P+E 16A 250V~ 1M

- 2P+E Italian P17/11
- 16A 250V~, type VM30
- in accordance with IEC 60884-1, CEI 23-50
- screw contacts 1.5-2.5 mm<sup>2</sup>
- shuttered live contacts

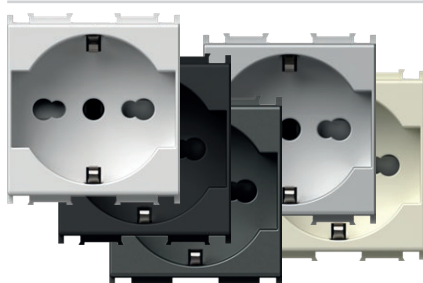

- VM31PW
- VM31SB
- VM31AT
- VM31ES
- VM31IW

## PRIZË SCHUKO/ITALIANE P17/11+KS 2P+E 16 A 250 V~ 2M

- 2P+E Schuko/Italiane P17/11
- 16 A 250 V~, lloji VM31
- në përputhje me IEC 60884-1, CEI 23-50
- kontaktet e vidave 1,5-2,5 mm<sup>2</sup>
- kontaktet me rrymën të mbuluara

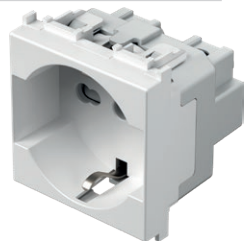

## SOCKET SCHUKO/ITA P17/11+KS

- 2P+E 16A 250V~ 2M
- 2P+E schuko/Italian P17/11
- 16A 250V~, type VM31
- in accordance with IEC 60884-1, CEI 23-50
- screw contacts 1.5-2.5 mm<sup>2</sup>
- shuttered live contacts

PRIZË SCHUKO/ITALIANE P30+KS 2P+E 16 A 250 V~ 2M

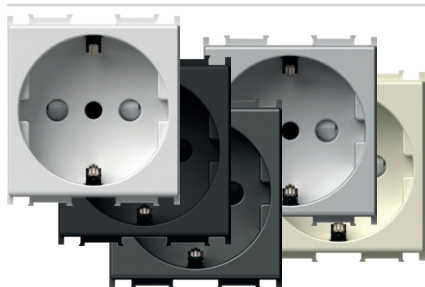

- VM32PW
- VM32SB
- VM32AT
- VM32ES
- VM32IW

- 2P+E Schuko/Italiane P30
- 16 A 250 V~, lloji VM32
- në përputhje me IEC 60884-1, CEI 23-50
- kontaktet e vidave 1,5-2,5 mm<sup>2</sup>
- kontaktet me rrymën të mbuluara



SOCKET SCHUKO/ITA P30+KS

- 2P+E 16A 250V~ 2M
- 2P+E schuko/Italian P30
  - 16A 250V~, type VM32
  - in accordance with IEC 60884-1, CEI 23-50
  - screw contacts 1.5-2.5 mm<sup>2</sup>
  - shuttered live contacts

PRIZË ITALIANE P11+KS 2P+E 10A 250 V~ 1M

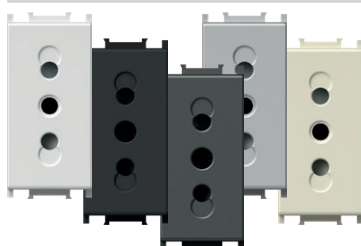

- VM33PW
- VM33SB
- VM33AT
- VM33ES
- VM33IW

- 2P+E Italiane P11
- 10A 250 V~, lloji VM33
- në përputhje me IEC 60884-1, CEI 23-50
- kontaktet e vidave 1,5-2,5 mm<sup>2</sup>
- kontaktet me rrymën të mbuluara



SOCKET ITALIAN P11+KS 2P+E 10A 250V~ 1M

- 2P+E Italian P11
- 10A 250V~, type VM33
  - in accordance with IEC 60884-1, CEI 23-50
  - screw contacts 1.5-2.5 mm<sup>2</sup>
  - shuttered live contacts

PRIZË EURO/AMERIKANE+KS 2P 16A 250 V~ 1M

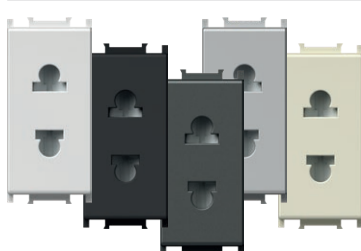

- VM21PW
- VM21SB
- VM21AT
- VM21ES
- VM21IW

- 2P Euro/Amerikane
- 16 A 250 V~, lloji VM21
- kontaktet e vidave 1,5-2,5 mm<sup>2</sup>
- kontaktet me rrymën të mbuluara
- vetëm për vendet jashtë BE-së



SOCKET EURO/AMERICAN+KS 2P 16A 250V~ 1M

- 2P Euro/American
- 16A 250V~, type VM21
  - screw contacts 1.5-2.5 mm<sup>2</sup>
  - shuttered live contacts
  - only for countries not members of EU

PRIZË BRITANIKE BS 1363-2+KS 2P+E 13 A 250 V~ 2M

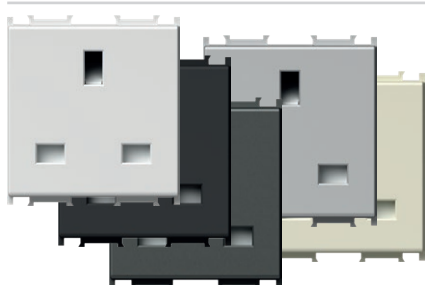

- VM52PW
- VM52SB
- VM52AT
- VM52ES
- VM52IW

- 2P+E Britanike BS 1363-2
- 13 A 250 V~, lloji VM52
- në përputhje me BS 1363-2
- kontaktet e vidave 1,5-4 mm<sup>2</sup>
- kontaktet me rrymën të mbuluara



SOCKET BRITISH BS 1363-2+KS 2P+E 13A 250V~ 2M

- 2P+E British BS 1363-2
- 13A 250V~, type VM52
  - in accordance with BS 1363-2
  - screw contacts 1.5-4 mm<sup>2</sup>
  - shuttered live contacts

PRIZA MULTISTANDARDE+KS 2P+E 13A 250V~ 2M

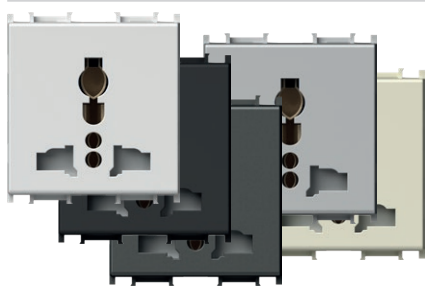

- VM55PW
- VM55SB
- VM55AT
- VM55ES
- VM55IW

- kontakte spinash 1,5-2,5 mm<sup>2</sup>
- mbrojtje e integruar nga kontakti

SOCKET MULTI-STANDARD+KS 2P+E 13A 250V~ 2M

- plug-in contacts 1.5-2.5 mm<sup>2</sup>
- built-in contact protection



MBROJTËS NGA MBIRRYMA MPE MINI 275 V/50 Hz



VM80

- lidhje paralele me prizën e parë në radhë
- mbrojtje e klasit III
- U<sub>c</sub>=275 V ac, U<sub>oc</sub>/I<sub>sc</sub>=6 kV/3 kA, U<sub>p</sub><800 V
- në përputhje me IEC 61643-1
- telat 1,5 mm<sup>2</sup>, IP20
- sinjalistik gjatë shpërthjes





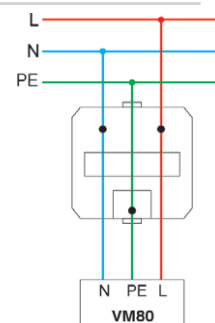









SURGE PROTECTOR MPE MINI 275V/50Hz

- parallel connection with the first socket in the row
- protection class III
  - U<sub>c</sub>=275Vac, U<sub>oc</sub>/I<sub>sc</sub>=6kV/3kA, U<sub>p</sub><800V
  - in accordance with IEC 61643-1
  - wires 1.5mm<sup>2</sup>, IP20
  - sound signal at breakdown





S O C K E T S V M

PËRSHTATJE E PRIZAVE DHE SPINAVE  
SOCKETS AND PLUGS MATCHING

PRIZA / SOCKET									
LLOJI I SPINËS / PLUG STYLE	VM10 VM11	VM20	VM30	VM33	VM31	VM32	VM40 VM41	VM21	VM55
Gjermane / German 	•				•	•			•
Franceze / French 	•				•	•	•		•
Italiene / Italian S11 			•	•	•	•			•
Italiene / Italian S17 			•		•				•
Euro 	•	•	•		•	•	•	•	•

PËRSHTATJE E PRIZAVE DHE SPINAVE  
SOCKETS AND PLUGS MATCHING

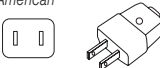
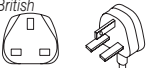
PRIZA / SOCKET			
LLOJI I SPINËS / PLUG STYLE	VM21	VM52	VM55
Amerikane / American 	•		•
Britanike / British BS 1363-2 		•	•

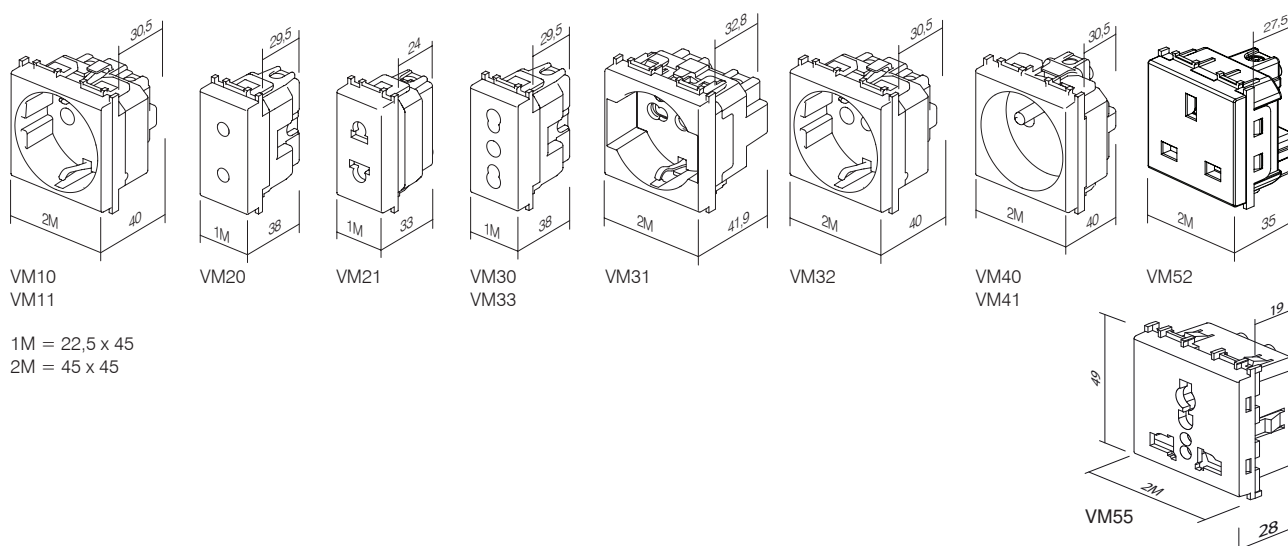



lloji type	përshkrimi description	të dhënat teknike technical data	madhësia size	ngjyra colour
KM10	PRIZË TV BAZË SOCKET TV BASIC	0dB	1M	<input type="checkbox"/> PW e bardhë polare polar white
KM11	PRIZË TV ME KAPAK FUNDOR SOCKET TV END-LINE	1dB	1M	<input checked="" type="checkbox"/> SB e zezë soft touch soft touch black
KM12	PRIZË TV KALUESE SOCKET TV TROUGHPASS	10dB	1M	<input checked="" type="checkbox"/> AT antracit anthracite
·	·	·	·	<input type="checkbox"/> ES e argjendtë elox elox silver
·	·	·	·	<input type="checkbox"/> IW e bardhë fildishi ivory white

PRIZË TV BAZË 0dB 1M

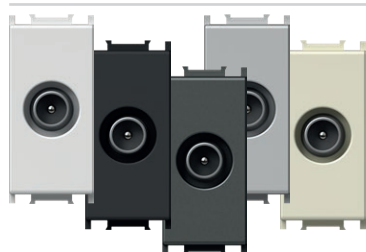

- KM10PW
- KM10SB
- KM10AT
- KM10ES
- KM10IW

- TV bazë  
- reduktim 0dB  
- lidhje e pasme – F standarde  
*SOCKET TV BASIC 0dB 1M*  
- TV basic  
- reduction 0dB  
- back connector – F standard



PRIZË TV BAZË 0dB 2M

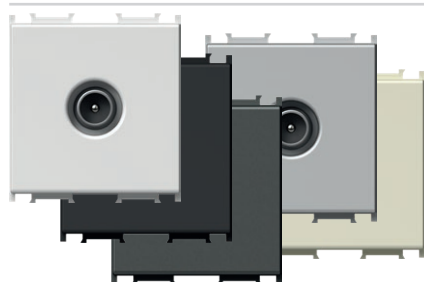

- KM20PW
- KM20SB
- KM20AT
- KM20ES
- KM20IW

- TV bazë  
- reduktim 0dB  
- lidhje e pasme – F standarde  
*SOCKET TV BASIC 0dB 2M*  
- TV basic  
- reduction 0dB  
- back connector – F standard



PRIZË TV ME KAPAK FUNDOR 1dB 1M

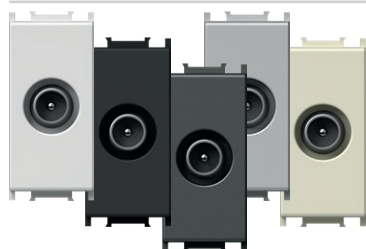

- KM11PW
- KM11SB
- KM11AT
- KM11ES
- KM11IW

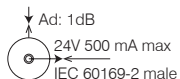

- TV me kapak fundor  
- gama e frekuencës 5÷2400 MHz  
- reduktimi < 1 dB  
- në përputhje me EN 50083-1  
- kontaktet e vidave  
*SOCKET TV END-LINE 1dB 1M*  
- TV end-line  
- frequency range 5÷2400 MHz  
- reduction < 1 dB  
- in accordance with EN 50083-1  
- screw contacts



PRIZË TV KALUESE 10dB 1M

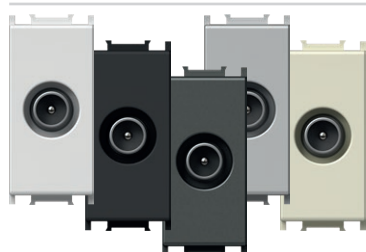

- KM12PW
- KM12SB
- KM12AT
- KM12ES
- KM12IW

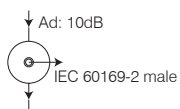

- TV kaluese  
- gama e frekuencës 5÷2400 MHz  
- reduktimi < 10 dB  
- në përputhje me EN 50083-1  
- kontaktet e vidave  
*SOCKET TV TROUGHPASS 10dB 1M*  
- TV troughpass  
- frequency range 5÷2400 MHz  
- reduction < 10 dB  
- in accordance with EN 50083-1  
- screw contacts



## PRIZË SAT BAZË 0dB 1M



- KM15PW
- KM15SB
- KM15AT
- KM15ES
- KM15IW

- SAT bazë
- reduktim 0dB
- lidhje e pasme – F standarde
- SOCKET SAT BASIC 0dB 1M*
- SAT basic
- reduction 0dB
- back connector – F standard



## PRIZË SAT BAZË 0dB 2M

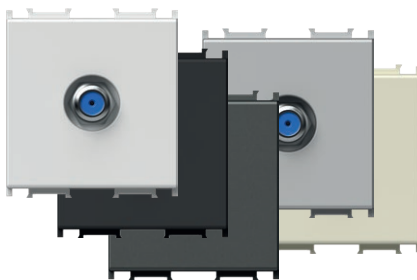

- KM24PW
- KM24SB
- KM24AT
- KM24ES
- KM24IW

- SAT bazë
- reduktim 0dB
- lidhje e pasme – F standarde
- SOCKET SAT BASIC 0dB 2M*
- SAT basic
- reduction 0dB
- back connector – F standard



## PRIZË SAT ME KAPAK FUNDOR 1dB 1M

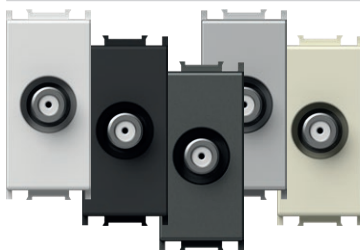

- KM16PW
- KM16SB
- KM16AT
- KM16ES
- KM16IW

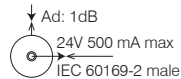

- SAT me kapak fundor
- gama e frekuencës 5÷2400 MHz
- reduktim < 0dB
- në përputhje me EN 50083-1
- kontaktet e vidave
- SOCKET SAT END-LINE 1dB 1M*
- SAT end-line
- frequency range 5÷2400 MHz
- reduction < 1dB
- in accordance with EN 50083-1
- screw contacts



## PRIZË R BAZË 0dB 1M



- KM19PW
- KM19SB
- KM19AT
- KM19ES
- KM19IW

- R bazë
- reduktim 0dB
- lidhje e pasme – F standarde
- SOCKET R BASIC 0dB 1M*
- R basic
- reduction 0dB
- back connector – F standard



## PRIZË R BAZË 0dB 2M

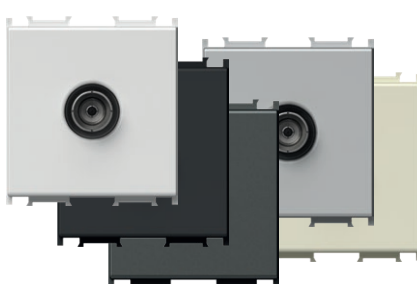

- KM29PW
- KM29SB
- KM29AT
- KM29ES
- KM29IW

- R bazë
- reduktim 0dB
- lidhje e pasme – F standarde
- SOCKET R BASIC 0dB 2M*
- R basic
- reduction 0dB
- back connector – F standard



## PRIZË SAT-TV ME KAPAK FUNDOR 1dB 2M

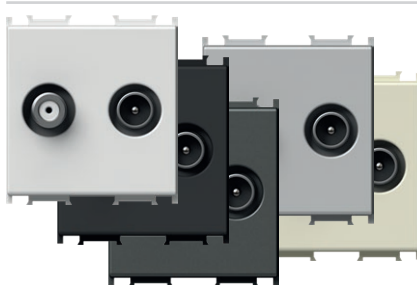

- KM25PW
- KM25SB
- KM25AT
- KM25ES
- KM25IW

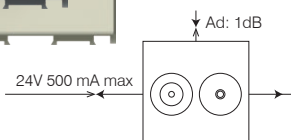

- SAT-TV me kapak fundor
- gama e frekuencës 5÷2400 MHz
- reduktim < 0dB
- në përputhje me EN 50083-1
- kontaktet e vidave
- SOCKET SAT-TV END-LINE 1dB 2M*
- SAT-TV end-line
- frequency range 5÷2400 MHz
- reduction < 1dB
- in accordance with EN 50083-1
- screw contacts



SHEMBUJ TË LIDHJEVE BAZË  
BASIC CONNECTION SAMPLES

lidhje individuale  
stand alone connection

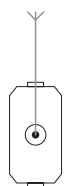

KM10  
KM20  
KM11  
KM15  
KM24  
KM16  
KM19  
KM29  
KM25

lidhje yll  
star connection

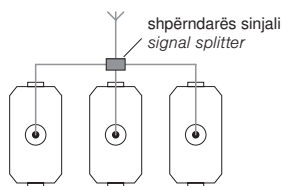

KM10  
KM20  
KM11  
KM15  
KM24  
KM16  
KM19  
KM29  
KM25

lidhje kaluese  
throughpass connection

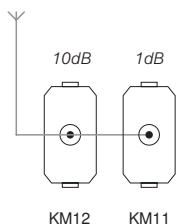

PRIZË AUDIO 2xRCA 1M



- KM22PW
- KM22SB
- KM22AT
- KM22ES
- KM22IW

- audio 2x RCA
- lidhje me ngjitje e kablos në pjesën e pasme

SOCKET AUDIO 2xRCA 1M

- audio 2x RCA
- soldering connection of cable at the back side



PRIZË AUDIO ALTOPARLANTË 1M



- KM23PW
- KM23SB
- KM23AT
- KM23ES
- KM23IW

- audio 2x Ø4mm
- për të mbajtur telin e altoparlantit, spinë banane Ø4mm ose pirun
- lidhje me ngjitje e kablos në pjesën e pasme

SOCKET AUDIO LOUDSPEAKERS 1M

- audio 2x Ø4mm
- to accommodate speaker wire, banana plug Ø4mm or spades
- soldering connection of cable at the back side



PRIZË AUDIO ALTOPARLANTË 2M



- KM26PW
- KM26SB
- KM26AT
- KM26ES
- KM26IW

- audio 2x Ø4mm
- për të mbajtur telin e altoparlantit, spinë banane Ø4mm ose pirun
- lidhje me ngjitje e kablos në pjesën e pasme

SOCKET AUDIO LOUDSPEAKERS 2M

- audio 2x Ø4mm
- to accommodate speaker wire, banana plug Ø4mm or spades
- soldering connection of cable at the back side



1M = 22,5 x 45  
2M = 45 x 45

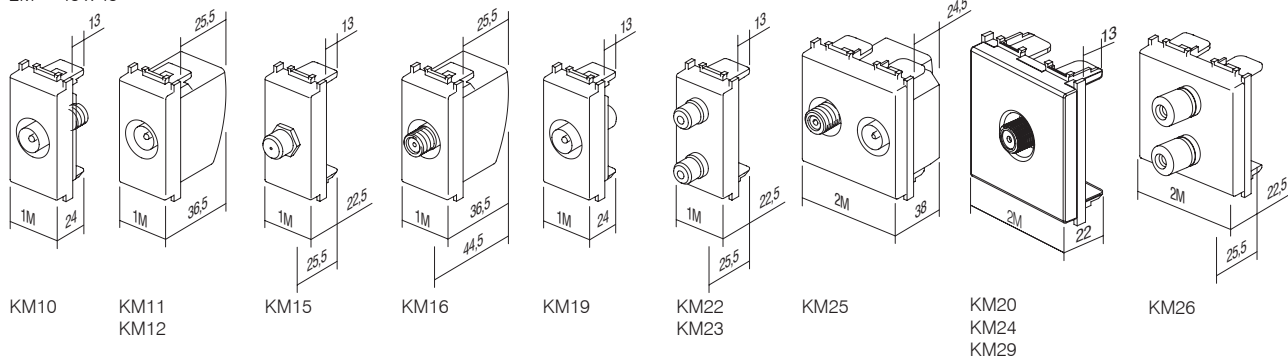

## PRIZË TEL LT RJ11 6/4 1M



- KM30PW
- KM30SB
- KM30AT
- KM30ES
- KM30IW

- vidë TEL LT
- RJ11 6/4
- në përputhje me IEC 60603-7
- kontaktet e vidave

*SOCKET TEL LT RJ11 6/4 1M*

- TEL LT screw
- RJ11 6/4
- in accordance with IEC 60603-7
- screw contacts



## PRIZË TEL BT SEC 6/6 1M

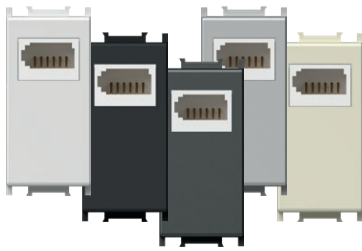

- KM31PW
- KM31SB
- KM31AT
- KM31ES
- KM31IW

- TEL BT Britanike standarde
- SEC dytësore 6/6
- në përputhje me BS 6312
- kontaktet e vidave

*SOCKET TEL BT SEC 6/6 1M*

- TEL BT British standard
- SEC secondary 6/6
- in accordance with BS 6312
- screw contacts



## PRIZË TEL KS RJ11 6/4 1M

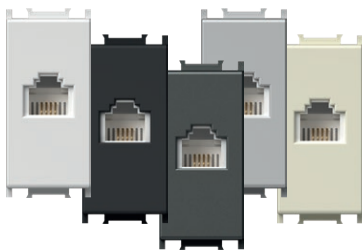

- KM36PW
- KM36SB
- KM36AT
- KM36ES
- KM36IW

- standard fiksues trapez KS
- RJ11 6/4
- në përputhje me IEC 60603-7

*SOCKET TEL KS RJ11 6/4 1M*

- KS keystone fixing standard
- RJ11 6/4
- in accordance with IEC 60603-7

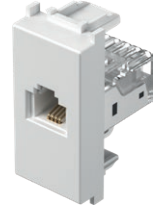

## PRIZË CAT5e KS RJ45 8/8 1M

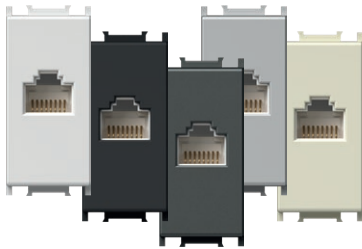

- KM37PW
- KM37SB
- KM37AT
- KM37ES
- KM37IW

- standard fiksues trapez KS
- CAT5e, RJ45 8/8
- në përputhje me IEC 60603-7

*SOCKET CAT5e KS RJ45 8/8 1M*

- KS keystone fixing standard
- CAT5e, RJ45 8/8
- in accordance with IEC 60603-7

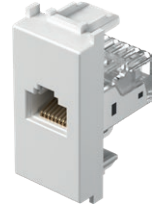

## PËRSHTATËS KS 1M

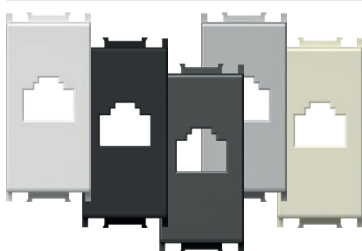

- KM35PW
- KM35SB
- KM35AT
- KM35ES
- KM35IW

- standard fiksues trapez KS
- AMP, Avaya, Brandrex, FMT, Mfico, Tyco, ...
- moduli i komunikimit nuk përfshihet

*ADAPTER KS 1M*

- KS keystone fixing standard
- AMP, Avaya, Brandrex, FMT, Mfico, Tyco, ...
- communication module not included



## PËRSHTATËS KS ME MBROJTJE NGA PLUHURI 1M



- KM38PW
- KM38SB
- KM38AT
- KM38ES
- KM38IW

- standard fiksues trapez KS me mbrojtje nga pluhuri
- AMP, Avaya, Brandrex, FMT, Mfico, Tyco, ...
- moduli i komunikimit nuk përfshihet

*ADAPTER KS WITH DUST PROTECTION 1M*

- KS keystone fixing standard with dust protection
- AMP, Avaya, Brandrex, FMT, Mfico, Tyco, ...
- communication module not included



PRIZË CAT6 SCH KS RJ45 8/8 1M

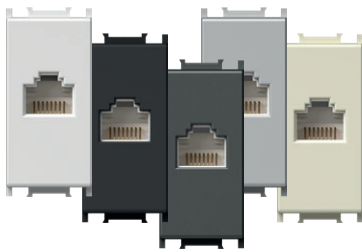

- KM39PW
- KM39SB
- KM39AT
- KM39ES
- KM39IW

- standard fiksues trapez KS
- CAT6 UTP pa vegla, RJ45 8/8
- në përputhje me ISO/IEC 11801

*SOCKET CAT6 SCH KS RJ45 8/8 1M*

- KS keystone fixing standard
- CAT6 UTP toolless, RJ45 8/8
- in accordance with ISO/IEC 11801



PËRSHTATËS KS UNIVERSAL 1M

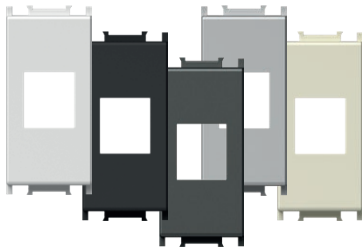

- KM50PW
- KM50SB
- KM50AT
- KM50ES
- KM50IW

- standard fiksues trapez KS
- i përshtatshëm për HDMI, USB
- moduli i komunikimit nuk përfshihet

*ADAPTER KS UNIVERSAL 1M*

- KS keystone fixing standard
- suitable for HDMI, USB
- communication module not included



PËRSHTATËS PD 1M

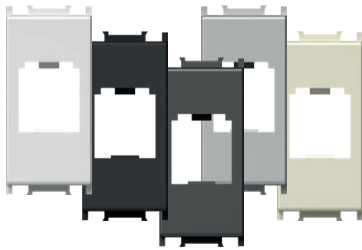

- KM40PW
- KM40SB
- KM40AT
- KM40ES
- KM40IW

- standard fiksues PD Panduit Mini-COM
- moduli i komunikimit nuk përfshihet

*ADAPTER PD 1M*

- PD Panduit Mini-COM fixing standard
- communication module not included



PËRSHTATËS PD ME MBROJTJE NGA PLUHURI 1M



- KM43PW
- KM43SB
- KM43AT
- KM43ES
- KM43IW

- standard fiksues PD Panduit Mini-COM me mbrojtje nga pluhuri
- moduli i komunikimit nuk përfshihet

*ADAPTER PD WITH DUST PROTECTION 1M*

- PD Panduit Mini-COM fixing standard with dust protection
- communication module not included



PËRSHTATËS R&M 1M

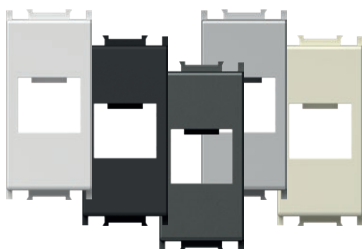

- KM46PW
- KM46SB
- KM46AT
- KM46ES
- KM46IW

- standard fiksues R&M
- moduli i komunikimit nuk përfshihet

*ADAPTER R&M 1M*

- R&M fixing standard
- communication module not included



PËRSHTATËS R&M CAT6A 1M

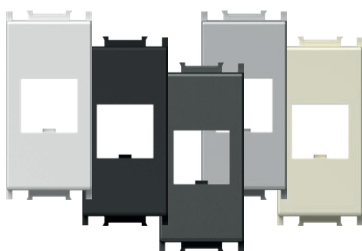

- KM52PW
- KM52SB
- KM52AT
- KM52ES
- KM52IW

- fiksues R&M për CAT6A
- moduli i komunikimit nuk përfshihet

*ADAPTER R&M CAT6A 1M*

- R&M fixing for CAT6A
- communication module not included







- KM47PW
- KM47SB
- KM47AT
- KM47ES
- KM47IW

#### PËRSHTATËS R&M ME MBROJTJE NGA PLUHURI 1M

- standard fiksues R&M me mbrojtje nga pluhuri
- moduli i komunikimit nuk përfshihet

#### ADAPTER R&M WITH DUST PROTECTION 1M

- R&M fixing standard with dust protection
- communication module not included



- KM53PW
- KM53SB
- KM53AT
- KM53ES
- KM53IW

#### PËRSHTATËS R&M CAT6A ME MBROJTJE NGA PLUHURI 1M

- fiksues R&M për CAT6A me mbrojtje nga pluhuri
- moduli i komunikimit nuk përfshihet

#### ADAPTER R&M CAT6A WITH DUST PROTECTION 1M

- R&M fixing for CAT6A with dust protection
- communication module not included



### PËRSHTATËS LK 1M

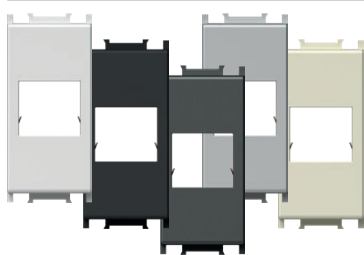

- KM45PW
- KM45SB
- KM45AT
- KM45ES
- KM45IW

- standard fiksues LK LeoniKerpen eLine / BKS NewLine
- moduli i komunikimit nuk përfshihet

#### ADAPTER LK 1M

- LK LeoniKerpen eLine / BKS NewLine fixing standard
- communication module not included



### PËRSHTATËS NEXANS/SCHRACK 2M

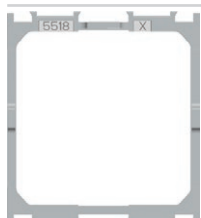

KA26

- përshtatës fiksues për Nexans LANmark dhe LANmark në Schrack velikosti 45x45 mm
- modul Schrack 45x45 mm
- e përshtatshme për Schrack llojin HSEMD02W2F
- moduli i komunikimit nuk përfshihet

#### ADAPTER NEXANS/SCHRACK 2M

- fixing adapter for Nexans LANmark and Schrack module 45x45mm
- suitable for Nexans type N423.540N
- suitable for Schrack type HSEMD02W2F
- communication module not included

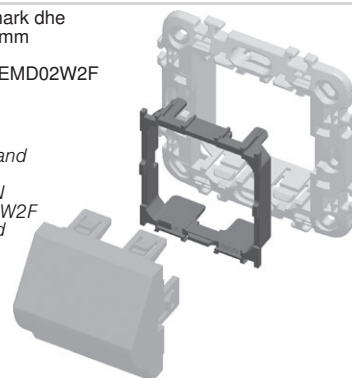

### PËRSHTATËS AT&T SYSTIMAX ME MBROJTJE NGA PLUHURI 1M

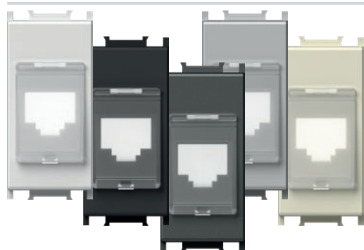

- KM48PW
- KM48SB
- KM48AT
- KM48ES
- KM48IW

- standard fiksues AT&T Systimax me mbrojtje nga pluhuri
- moduli i komunikimit nuk përfshihet

#### ADAPTER AT&T SYSTIMAX WITH DUST PROTECTION 1M

- AT&T Systimax fixing standard with dust protection
- communication module not included



### PRIZË USB LLOJI A 1M



- KM51PW
- KM51SB
- KM51AT
- KM51ES
- KM51IW

- prizë USB 2.0 lloji A
- kontaktet e vidave, raster 5 mm, 1,5 mm<sup>2</sup>, 1x2P + 1x3P
- lidhjet elektrike:
  - KUNJJI 1 – VCC (+5V, teli i kuq)
  - KUNJJI 2 – Të dhëna - (teli i bardhë)
  - KUNJJI 3 – Të dhëna + (teli i gjelbër)
  - KUNJJI 4 – GND - tokëzimi (teli i zi)
  - S – mbrojtja
- në përputhje me direktivën 2011/95/EU (RoHS2)

#### SOCKET USB TYPE A 1M

- USB 2.0 socket type A
- screw contacts, raster 5 mm, 1,5 mm<sup>2</sup>, 1x2P + 1x3P
- wiring:
  - PIN 1 – VCC (+5V, red wire)
  - PIN 2 – Data - (white wire)
  - PIN 3 – Data + (green wire)
  - PIN 4 – GND - ground (black wire)
  - S – shield
- in accordance with directive 2011/95/EU (RoHS2)



1M = 22,5 x 45  
2M = 45 x 45

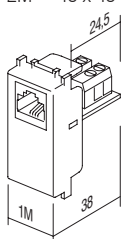

KM30

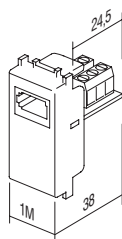

KM31

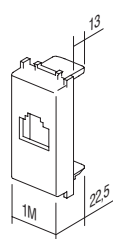

KM35  
KM38  
KM48

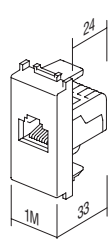

KM36  
KM37  
KM39

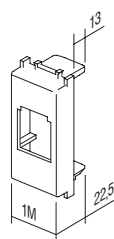

KM40  
KM43

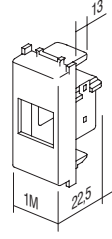

KM45

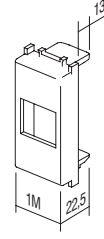

KM46  
KM47  
KM50  
KM52  
KM53

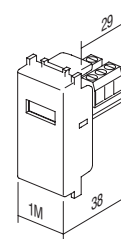

KM51



KA10

Iloji type	përshkrimi description	të dhënat teknike technical data
KA10	KONEKTORI KS CAT3 CONNECTOR KS CAT3	RJ11 6/4
KA11	KONEKTORI KS CAT5e CONNECTOR KS CAT5e	RJ45 8/8
KA12	KONEKTORI KS CAT5eS CONNECTOR KS CAT5eS	RJ45 8/8
⋮	⋮	⋮



KA10

## KONEKTORI KS CAT3 RJ11 6/4

- standard fiksues trapez KS
- CAT3, RJ11 6/4
- në përputhje me IEC 60603-7

*CONNECTOR KS CAT3 RJ11 6/4*  
 - KS keystone fixing standard  
 - CAT3, RJ11 6/4  
 - in accordance with IEC 60603-7



KA11

## KONEKTORI KS CAT5e RJ45 8/8

- standard fiksues trapez KS
- CAT5e, RJ45 8/8
- në përputhje me IEC 60603-7

*CONNECTOR KS CAT5e RJ45 8/8*  
 - KS keystone fixing standard  
 - CAT5e, RJ45 8/8  
 - in accordance with IEC 60603-7



KA12

## KONEKTORI KS CAT5eS RJ45 8/8

- standard fiksues trapez KS
- CAT5eS, RJ45 8/8
- në përputhje me IEC 60603-7

*CONNECTOR KS CAT5eS RJ45 8/8*  
 - KS keystone fixing standard  
 - CAT5eS, RJ45 8/8  
 - in accordance with IEC 60603-7



KA15

## KONEKTORI KS CAT6 SCH RJ45 8/8

- standard fiksues trapez KS
- CAT6 UTP pa vegla, RJ45 8/8
- në përputhje me ISO/IEC 11801

*CONNECTOR KS CAT6 SCH RJ45 8/8*  
 - KS keystone fixing standard  
 - CAT6 UTP toolless, RJ45 8/8  
 - in accordance with ISO/IEC 11801



KA16

## KONEKTORI KS CAT6S SCH RJ45 8/8

- standard fiksues trapez KS
- CAT6S STP pa vegla, RJ45 8/8
- në përputhje me ISO/IEC 11801

*CONNECTOR KS CAT6S SCH RJ45 8/8*  
 - KS keystone fixing standard  
 - CAT6S STP toolless, RJ45 8/8  
 - in accordance with ISO/IEC 11801



KA17

## KONEKTORI KS CAT6a SCH RJ45 8/8

- standard fiksues trapez KS
- CAT6a STP pa vegla, RJ45 8/8
- në përputhje me ISO/IEC 11801

*CONNECTOR KS CAT6a SCH RJ45 8/8*  
 - KS keystone fixing standard  
 - CAT6a STP toolless, RJ45 8/8  
 - in accordance with ISO/IEC 11801



KA18

#### KONEKTORI SLIM KS CAT6S SCH RJ45 8/8

- standard fiksues trapez KS
- stil slim
- CAT6S STP pa vegla, RJ45 8/8
- në përputhje me ISO/IEC 11801
- i përshtatshëm edhe për përshtatës dysh KE46

#### CONNECTOR SLIM KS CAT6S SCH RJ45 8/8

- KS keystone fixing standard
- slim style
- CAT6S STP toolless, RJ45 8/8
- in accordance with ISO/IEC 11801
- suitable also for KE46 double adapter



KA27

#### KONEKTORI KS HDMI

- standard fiksues trapez KS
- vetëm në kombinim me përshtatësin KM50
- HDMI/HDMI

#### CONNECTOR KS HDMI

- KS keystone fixing standard
- only in combination with adapter KM50
- HDMI/HDMI



KA28

#### KABLOJA KS HDMI

- standard fiksues trapez KS
- vetëm në kombinim me përshtatësin KM50
- HDMI/HDMI

#### CABLE KS HDMI

- KS keystone fixing standard
- only in combination with adapter KM50
- HDMI/HDMI



EM31



PW



Iloji type	përshkrimi description	të dhënat teknike technical data	madhësia size	ngjyra colour	
EM12	REOSTAT RROTULLUES/2 DREJTIME DIMMER ROTATIVE 2WAY	RL 300W	1M	<input type="checkbox"/> PW e bardhë polare polar white	<input type="checkbox"/> BL blu blue
EM23	REOSTAT ME MONTIM NË KUTI DIMMER INBOX	R (250 W), (RC,RL 200VA)	/	<input checked="" type="checkbox"/> SB e zezë soft touch soft touch black	<input checked="" type="checkbox"/> RD e kuqe red
.	.	.	.	<input type="checkbox"/> AT antracit anthracite	<input type="checkbox"/> GR e gjelbër green
.	.	.	.	<input type="checkbox"/> ES e argjendtë elox elox silver	<input type="checkbox"/> OR portokalli orange
.	.	.	.	<input type="checkbox"/> IW e bardhë fildishi ivory white	<input type="checkbox"/> RG e kuqe/e gjelbër red/green

#### REOSTAT RROTULLUES/2 DREJTIME RL 300W 1M



- EM12PW
- EM12SB
- EM12AT
- EM12ES
- EM12IW

- kontrolli i rrotullimit me çelësin me 2 drejtime
- RL i ngarkesës, 40 W - 300 W
- tensioni i furnizimit, 230 V ~ 50 Hz
- është i mundur kombinimi i çelësit me 2 drejtime
- instalimi i disa njësive bashkë në një kuti lejohet vetëm nëse ngarkesa maksimale totale e tyre nuk tejkalon fuqinë maksimale të një reostati të vetëm
- një qark lejon përdorimin e vetëm një reostati
- nuk ka siguresë të integruar - duhet të përdoret siguresa e jashtme
- në përputhje me EN 60669-1
- kontaktet e vidave 1,5-2,5 mm<sup>2</sup>
- treguesi i integruar LED i nivelit të ndriçimit



#### DIMMER ROTATIVE/2WAY RL 300W 1M

- rotation control with 2-way switch
- load RL, 40W - 300W
- supply voltage 230V ~ 50Hz
- 2-way switch combination is possible
- installing several devices together in one box is only permitted if their total maximum load does not exceed the maximum power of a single dimmer
- one circuit allows the use of only one dimmer
- no built-in fuse - external fuse must be used
- in accordance with EN 60669-1
- screw contacts - 1.5-2.5mm<sup>2</sup>
- integrated LED indication of dimming level

#### REOSTAT RROTULLUES/2 DREJTIME LED 60W 1M



- EM13PW
- EM13SB
- EM13AT
- EM13ES
- EM13IW

- kontrolli i rrotullimit me çelësin me 2 drejtime
- ngarkesat: LED, 0 - 60W (maks. 6 llamba LED me ulje ndriçimi)
- GLS, 0 - 60 W
- tensioni i furnizimit, 230 V ~ 50 Hz
- është i mundur kombinimi i çelësit me 2 drejtime
- instalimi i disa njësive bashkë në një kuti lejohet vetëm nëse ngarkesa maksimale totale e tyre nuk tejkalon fuqinë maksimale të një reostati të vetëm
- një qark lejon përdorimin e vetëm një dimeri
- nuk ka siguresë të integruar - duhet të përdoret siguresa e jashtme
- në përputhje me EN-2-1
- kontaktet e vidave 1,5-2,5 mm<sup>2</sup>



#### DIMMER ROTATIVE/2WAY LED 60W 1M

- rotation control with 2-way switch
- loads: LED, 0 - 60W (max. 6 dimmable LED lamps)
- GLS, 0 - 60W
- supply voltage 230V ~ 50Hz
- 2-way switch combination is possible
- installing several devices together in one box is only permitted if their total maximum load does not exceed the maximum power of a single dimmer
- one circuit allows the use of only one dimmer
- no built-in fuse - external fuse must be used
- in accordance with IEC60669-2-1
- screw contacts - 1.5-2.5mm<sup>2</sup>



- EM14PW
- EM14SB
- EM14AT
- EM14ES
- EM14IW

#### REOSTAT RROTULLUES/2 DREJTME LED 180W 1M

- kontroll i rrotullimit me çelësin me 2 drejtime
- ngarkesat:
  - LED, 0 – 180 W (maks. 20 llamba LED me ulje ndriçimi)
  - GLS, 0 – 180 W
- tensioni i furnizimit, 230 V ~ 50 Hz
- është i mundur kombinimi i çelësit me 2 drejtime
- instalimi i disa njësjive bashkë në një kuti lejohet vetëm nëse ngarkesa maksimale totale e tyre nuk tejkalon fuqinë maksimale të një reostatit të vetëm
- një qark lejon përdorimin e vetëm një dimeri
- nuk ka siguresë të integruar - duhet të përdoret siguresa e jashtme
- në përputhje me EN-2-1
- kontaktet e vidave 1,5-2,5 mm<sup>2</sup>



#### DIMMER ROTATIVE/2WAY LED 180W 1M

- rotation control with 2-way switch
- loads:
  - LED, 0 – 180W (max. 20 dimmable LED lamps)
  - GLS, 0 – 180W
- supply voltage 230V~ 50Hz
- 2-way switch combination is possible
- installing several devices together in one box is only permitted if their total maximum load does not exceed the maximum power of a single dimmer
- one circuit allows the use of only one dimmer
- no built-in fuse – external fuse must be used
- in accordance with IEC60669-2-1
- screw contacts - 1.5-2.5mm<sup>2</sup>



- EM15PW
- EM15SB
- EM15AT
- EM15ES
- EM15IW

#### REOSTAT RROTULLUES R 250W 1M

- kontroll rrotullues pa çelës
- ngarkesa R, 40W - 250W
- tensioni i furnizimit, 230 V ~ 50 Hz
- nuk është i mundur kombinimi i çelësit me 2 drejtime
- nuk lejohet kombinimi i më shumë reostateve
- në përputhje me EN 60669-1
- kontaktet e vidave 1,5-2,5 mm<sup>2</sup>
- Treguesi LED



#### DIMMER ROTATIVE R 250W 1M

- rotation control without switch
- load R, 40W - 250W
- supply voltage 230V~ 50Hz
- 2-way switch combination is not possible
- more dimmers combination is not allowed
- in accordance with EN 60669-1
- screw contacts 1.5-2.5mm<sup>2</sup>
- LED indication



- EM16PW
- EM16SB
- EM16AT
- EM16ES
- EM16IW

#### 1-10 V ÇELËSI RROTULLUES ME DY DREJTME I REOSTATIT

- tensioni nominal i punës: 10 V DC
- tensioni minimal i punës: 0,7 VDC
- diapazoni i errësimit: 0,7 - 100% (në varësi të furnizimit me energji dhe të ngarkesës)
- rënia minimale e rrymës: 0,1 mA
- rënia maksimale e rrymës: 120 mA
- konsumi maksimal: 0,35 W
- mbrojtja nga mbitensioni: 15,8 V DC deri në 250 mA (jo e zëvendësueshme)
- rryma maksimale e impulsit: 3 A DC
- lloji i ngarkesës: 0-10 V, 1-10 V dhe PWM
- lloji i çelësit: mekanik: me shtypje për ndezje/fikje
- kablo nul: nuk nevojitet
- tensioni nominal i funksionimit: 100-240 V AC, 50-60 Hz
- rryma maksimale e menjëhershme: 10 A
- rryma maksimale e punës: 8 A
- ngarkesa maksimale (në 230 VAC): 1800 VA (1800 x pf = maksimumi W)
- rezistenca e izolimit: > 100 MΩ në 250 VAC
- mbrojtja nga mbitensionet dhe mbrojtja nga qarku i shkurtër: 10 A, 350 V AC (jo e zëvendësueshme)
- këndi i rrotullimit: 270 ° ± 5 °
- temperatura e punës: -5 deri në 40 °C
- temperatura e ruajtjes: -30 deri në 80 °C
- temperatura maksimale e strehimit: 65 °C
- lagështia maksimale: 90% (pa kondensim)
- EMC dhe imuniteti: CISPR 15 (2008), IEC 61547
- LVD: IEC 60669-1: 2017, IEC 60669-2-1: 2015



#### 1-10 V DIMMER ROTARY TOGGLE

- nominal operating voltage: 10 VDC
- minimum operating voltage: 0.7 VDC
- dimming range: 0.7% – 100% (depending on power supply and loads)
- minimum sink current: 0.1 mA
- maximum sink current: 120 mA
- maximum consumption: 0.35 W
- surge protection: 15.8 VDC up to 250 mA (not replaceable)
- maximum pulse current: 3 ADC
- load types: 0-10 V, 1-10 V and PWM
- switch type: mechanical: push on/off
- zero cable: not required
- nominal operating voltage: 100-240 VAC, 50-60 Hz
- maximum instantaneous current: 10 A
- maximum operating current: 8 A
- maximum load (at 230 VAC): 1800 VA (1800 x pf = max. W)
- isolation resistance: > 100 MΩ at 250 VAC
- surge protection and Short-circuit protection: 10 A, 350 VAC (not replaceable)
- rotation angle: 270° ± 5°
- operating temperature: -5 to 40°C
- storing temperature: -30 to 80°C
- maximum housing temperature: 65°C
- maximum humidity: 90% (no condensation)
- EMC & immunity: CISPR 15(2008), IEC 61547
- LVD: IEC 60669-1:2017, IEC 60669-2-1:2015



EM23

#### REOSTAT ME MONTIM NË KUTI R (250 W), (RC, RL 200 VA)

- montim në kuti, me kontroll me buton të jashtëm me shtypje
- RLC me ngarkesë 15-250 W ose 15-200 VA
- tensioni i furnizimit, 230 V ~ 50 Hz
- janë të mundura disa kombinime të butonave me shtypje
- nuk lejohet kombinim i më shumë reostateve
- memorizim i intensitetit të dritës
- funksion ndezje/ndalim i butë
- »leading edge«
- në përputhje me EN60669, EN60950, EN 61000, ETSI EN 300 220-1, ETSI EN 300 220-2
- kontaktet e vidave me tela 2,5 mm<sup>2</sup>

#### DIMMER INBOX R (250 W), (RC, RL 200 VA)

- inbox, controlled by external push button
- load RLC 15-250W or 15-200 VA
- supply voltage 230V~ 50Hz
- several push-buttons combinations are possible
- more dimmers combination is not allowed
- light intensity memory
- soft start/stop function
- »leading edge«
- in accordance with EN60669, EN60950, EN 61000, ETSI EN 300 220-1, ETSI EN 300 220-2
- screw contacts to wires 2,5 mm<sup>2</sup>



EM18

#### REOSTAT ME MONTIM NË KUTI LED 250 W

- montim në kuti, me kontroll me buton të jashtëm me shtypje
- për anën e përparme ose fundore
- tensioni i furnizimit, 230 V ~ 50 Hz
- janë të mundura disa kombinime të butonave me shtypje
- funksioni i memories së cilësimit të fundit, me përjashtim të rastit të ndërprerjes së energjisë
- funksioni i ndezjes/ndalimit të butë
- kontrolli i intensitetit minimal
- vetëm një reostat për kuti muri
- vetëm për përdorim të brendshëm
- në përputhje me standardet EN 60669-1 dhe EN 60669-2-1

#### DIMMER INBOX LED 250W

- inbox, controlled by external push button
- for leading or trailing edge
- supply voltage 230V~ 50Hz
- several push-buttons combinations is possible
- memory function of the last setting, except in the case of a power failure
- soft start / stop function
- minimum intensity control
- only one dimmer per wall box
- only for indoor usage
- in accordance with EN 60669-1 and EN 60669-2-1



EM19

#### REOSTAT ME MONTIM NË KUTI DC LED 96 W

- montim në kuti, me kontroll me buton të jashtëm me shtypje
- për përdorim me drajverë për LED me tension konstant dhe disa drajverë për LED me rrymë konstante, 9-48 V DC, maks. 96 W (edhe për shiritat LED)
- jo për përdorim me ngarkesa me induksion
- janë të mundura kombinime të disa butonave me shtypje dhe disa reostateve
- funksioni i memories së cilësimit të fundit, me përjashtim të rastit të ndërprerjes së energjisë
- funksioni i ndezjes/ndalimit të butë
- vetëm një reostat për kuti muri
- vetëm për përdorim të brendshëm

#### DIMMER INBOX DC LED 96W

- inbox, controlled by external push button
- for use with constant voltage LED drivers and some constant current LED drivers, 9-48V DC, max 96W (also for LED strips)
- not for use with inductive loads
- several push-buttons combinations and several dimmers is possible
- memory function of the last setting, except in the case of a power failure
- soft start / stop function
- only one dimmer per wall box
- only for indoor usage

EM15 (40÷250W)

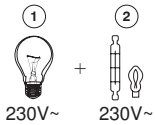

EM12 (40÷300W)

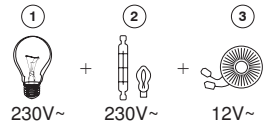

EM13 (0÷60W), EM14 (0÷180W),  
EM23 (15÷250W, 15÷200VA),  
EM18 (2÷250VA (3=10÷250VA), 2÷250W)

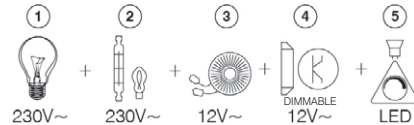

- 1 - llambë inkandeshente / incandescent lamp
- 2 - llambë halogjene / halogen lamp
- 3 - transformator klasik / classical transformer
- 4 - transformator elektrik me dimer / dimmable electronic transformer
- 5 - llambë LED me ulje ndriçimi / dimmable LED lamp

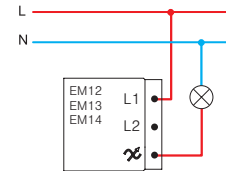
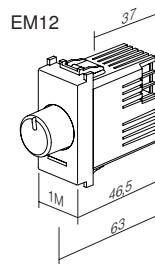
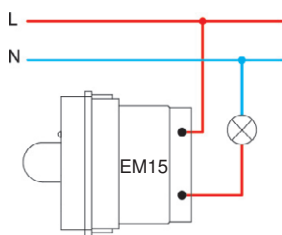
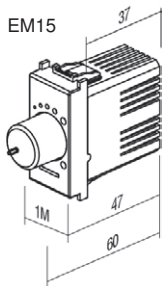

EM23

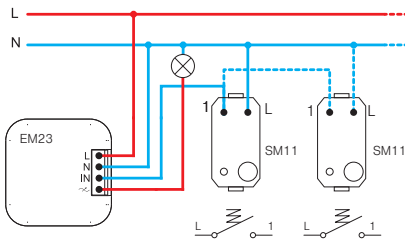
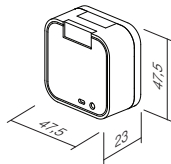

EM13, EM14

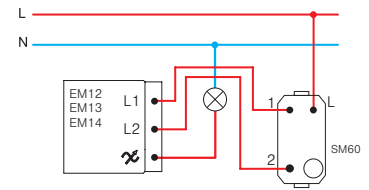
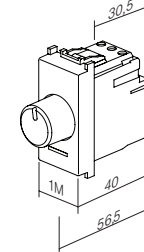

EM18

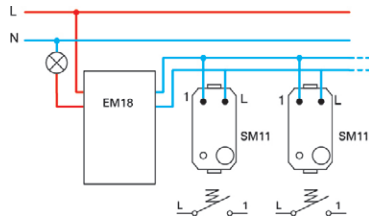
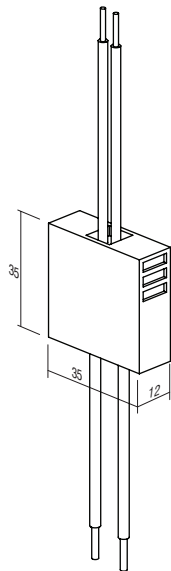

EM19

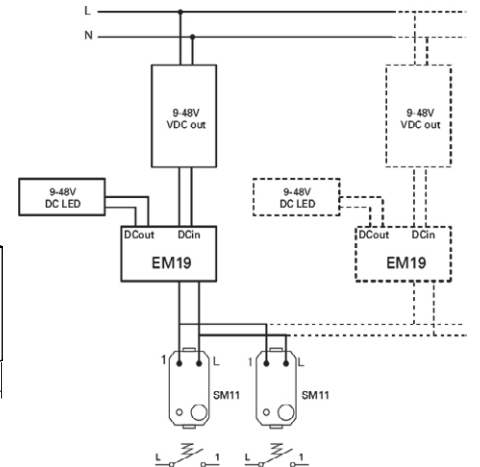
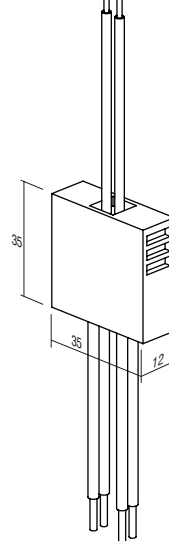

**KUJDES!**

Nëse lidhen më shumë reostatë në një kuti, reduktori fuqinë e përbashkët me 10% për secilin reostat.

**ATTENTION!**

If more dimmers are connected in one box reduce maximum common power for 10% for each dimmer.

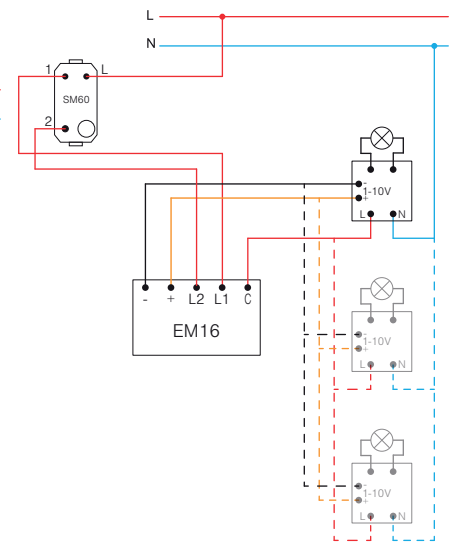
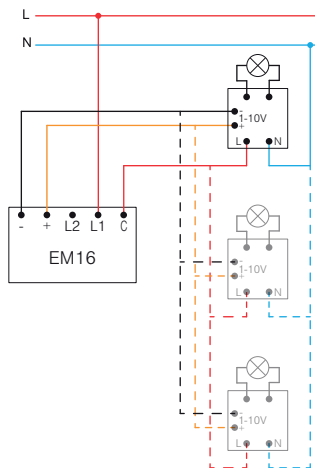
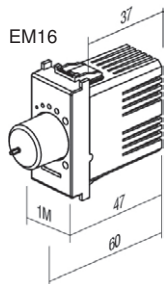
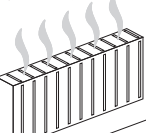





- EM25PW
- EM25SB
- EM25AT
- EM25ES
- EM25IW

TOUCH EM25 është një reostat elektronik ndriçimi i kontrolluar me mikroprocesor. Ai shërben si çelës dhe reostat për llambat me ulje ndriçimi dhe disa llamba pa ulje ndriçimi. Mikroprocesori i integruar identifikon automatikisht llojin e llambës dhe rregullon regjimin e funksionimit. Ai memorizon nivelin e uljes së ndriçimit pas fikjes falë funksionit të integruar të memorizimit. Funksioni i ndezjes së butë zgjat jetëgjatësinë e llambës. Në buton ndriçimi i integruar elegant LED mundëson ngjyra të ndryshme dhe nivele intensiteti. Ndonjëherë mund të lidheni me deri në 5 çelësa kontrolli shtesë EM26 ("slave") në EM 25.

TOUCH EM25 is microprocessor controlled electronic light dimmer. It serves as switch and dimmer for dimmable and some of non-dimmable lamps. Integrated microprocessor automatically identifies the type of lamp and adjusts the operating mode. It remembers the level of dimming after switching off due to integrated memory function. Soft-start function extends the lamp service life. In button integrated elegant LED illumination enables many different colours and intensity levels. Optionally one can connect up to 5 additional control tasters EM26 (>"slave"<).

### ÇELËS / REOSTAT UNIVERSAL RLC 0-300W 2M

- reostat universal elektronik për NDEZJE/FIKJE dhe ulje ndriçimi të të gjitha llambave me ulje ndriçimi (klasike, halogjene, LED, CFL, ...) dhe disa llambave pa ulje ndriçimi
- zbulim automatik i llojit të llambës dhe rregullimit të regjimit të funksionimit
- reduktim i konsumit të energjisë
- funksioni i ndezjes së butë zgjat jetëgjatësinë e llambave
- kontrolluar me mikro çelësa të integruar
- funksioni i memorizimit i përfshirë – memorizon ndriçimin në ndezje
- mund të lidhen deri në pesë (5) njësi kontrolli shtesë EM26
- nuk është e mundur lidhja me çelës me 2 drejtime
- qark i shkurtër i integruar, mbrojtje nga mbingarkesa dhe mbinxehja
- tensioni i furnizimit, 230 V ~ 50 Hz
- ndriçim elegant LED, ngjyra dhe ndriçim i rregullueshëm
- është e mundur zëvendësimi i çelësit klasik në lidhjen me dy tela (1)
- funksionimi i plotë arrihet në lidhjen me tre tela (2)
- në përputhje me standardet EN 60669-1 dhe EN 60669-2-1
- kontaktet e vidave 1,5mm<sup>2</sup> (forca maks. e shtrëngimit 0,4 Nm)

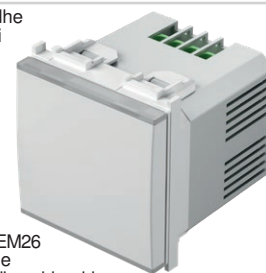

### SWITCH / DIMMER UNIVERSAL RLC 0-300W 2M

- universal electronic dimmer for ON/OFF switching and dimming of all dimmable lamps (classical, halogen, LED, CFL, ...) and some non-dimmable lamps
- automatic detection of lamp type and adjustment of operating mode
- reduction of energy consumption
- soft start function extends life of lamps
- controlled by build-in micro switches
- memory function included – memorizes brightness on turn-off
- up to five (5) additional control units EM26 can be connected
- connection with 2-way switch is not possible
- build-in short-circuit, overheating and overload protection
- supply voltage 230V ~ 50Hz
- elegant LED illumination, adjustable colour and brightness
- replacement of classical switch is possible at two-wire connection<sup>(1)</sup>
- full functionality is achieved at three-wire connection<sup>(2)</sup>
- in accordance with EN 60669-1 and EN 60669-2-1
- screw contacts 1.5mm<sup>2</sup> (max. tightening torque 0.4Nm)

(1) lidhje me dy tela  
two-wire connection

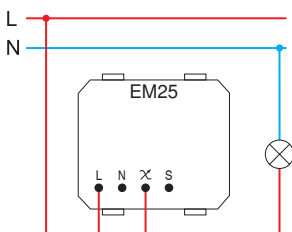

- lidhja me dy tela lejon uljen e ndriçimit të llambave me ulje ndriçimi
- two-wire connection allows dimming of dimmable lamps

(2) lidhje me tre tela  
three-wire connection

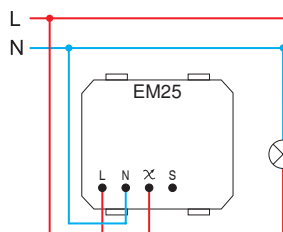

- lidhja me tre tela lejon uljen e ndriçimit të llambave me ulje ndriçimi dhe disa pa ulje ndriçimi dhe llambave CFL
- three-wire connection allows dimming of dimmable lamps and some of non-dimmable LED and CFL lamps

	1	2	5	6	7
Min.	40 W	40 W	40 VA	40 VA	40 VA
Max.	300 W	300 W	300 VA	100 VA	100 VA
	(F)	(F)	(F)		

- 1 - llambë inkandeshente / incandescent lamp
- 2 - llambë halogjene / halogen lamp
- 4 - transformator elektrik me dimer / dimmable electronic transformer
- 5 - transformator klasik / classical transformer

	1	2	4	6	7	8	9
Min.	0 W	0 W	0 VA	0 VA	0 VA	0 VA	0 VA
Max.	300 W	300 W	120 VA	120 VA	120 VA	120 VA	120 VA
	(F)	(F)	(F)			(F)	(F)

- 6 - llambë CLF me ulje ndriçimi me kursim energjie / dimmable energy saving CFL lamp
- 7 - llambë LED me ulje ndriçimi / dimmable LED lamp
- 8 - llambë CLF pa ulje ndriçimi me kursim energjie / non-dimmable energy saving CFL lamp
- 9 - llambë LED pa ulje ndriçimi / non-dimmable LED lamp

#### shënime / remarks

- (F) filtër EM27  
- rekomandohet të përdoret filtri EM27 /  
it is recommended to use filter EM27
- të gjitha llambat e kontrolluara duhet të jenë të njëjta /  
all controlled lamps must be the same
- tabela e ngarkesave është e vlefshme për llambat me faktor fuqie PF>0.5 /  
table of loads is valid for lamps with power factor PF>0.5

ndezje/fikje dhe ulje e ndriçimit të llambës /  
on / off swithcing and dimming of lamp

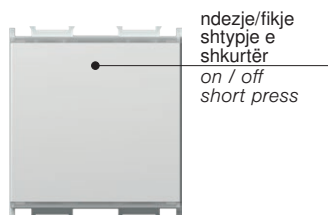

ndezje/fikje  
shtypje e  
shkurtër  
on / off  
short press

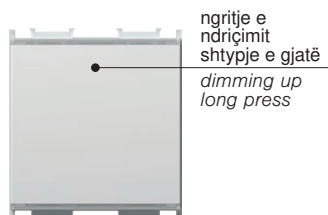

ngritje e  
ndriçimit  
shtypje e gjatë  
dimming up  
long press

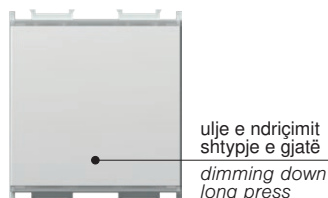

ulje e ndriçimit  
shtypje e gjatë  
dimming down  
long press

përzgjedhja e ngjyrave LED dhe rregullimi i nivelit të intensitetit /  
LED colour selection and intensity level adjustment

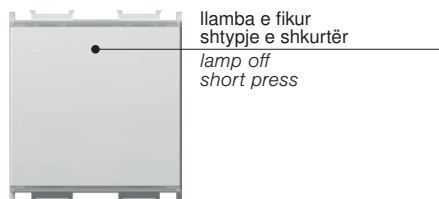

llamba e fikur  
shtypje e shkurtër  
lamp off  
short press

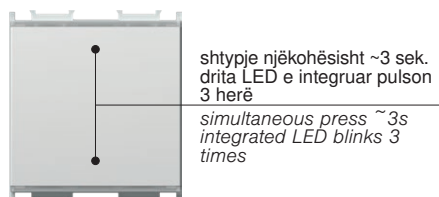

shtypje njëkohësisht ~3 sek.  
drita LED e integruar pulson  
3 herë  
simultaneous press ~3s  
integrated LED blinks 3  
times



përzgjedhje e ngjyrave  
shtypje e shkurtër  
colour selection  
short press

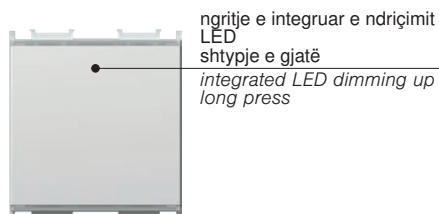

ngritje e integruar e ndriçimit  
LED  
shtypje e gjatë  
integrated LED dimming up  
long press

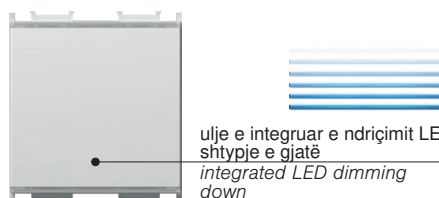

ulje e integruar e ndriçimit LED  
shtypje e gjatë  
integrated LED dimming  
down  
long press

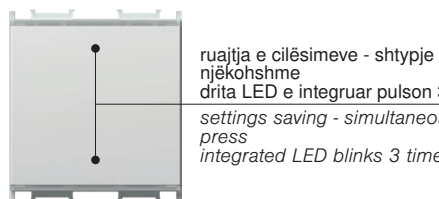

ruajtja e cilësimeve - shtypje e shkurtër e  
njëkohshme  
drita LED e integruar pulson 3 herë  
settings saving - simultaneous short  
press  
integrated LED blinks 3 times

\*funksion "RESET"/  
"RESET" function

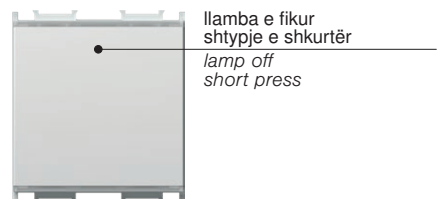

llamba e fikur  
shtypje e shkurtër  
lamp off  
short press

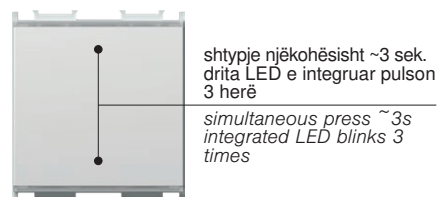

shtypje njëkohësisht ~3 sek.  
drita LED e integruar pulson  
3 herë  
simultaneous press ~3s  
integrated LED blinks 3  
times

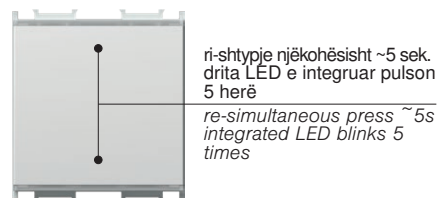

ri-shtypje njëkohësisht ~5 sek.  
drita LED e integruar pulson  
5 herë  
re-simultaneous press ~5s  
integrated LED blinks 5  
times

- \* - rekomandohet në instalimin e reostatit dhe ndërrimin e llambës
- e detyrueshme kur përdoren llamba pa ulje ndriçimi
- funksioni "RESET" nuk është i mundur kur përdoret lidhje me dy tela
- i mundur vetëm në EM25
- it is recommended at dimmer installation and lamp replacement
- mandatory when using non-dimmable lamps
- "RESET" function is not possible when using two-wire connection
- only possible on EM25

masat paraprake të instalimit /  
installation precautions

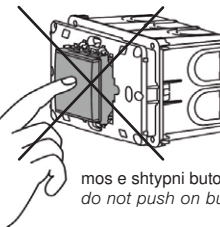
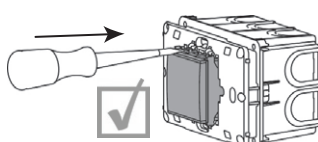
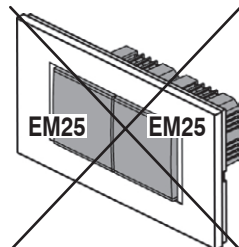
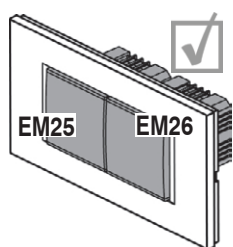

mos e shtypni butonin gjatë montimit /  
do not push on button during mounting

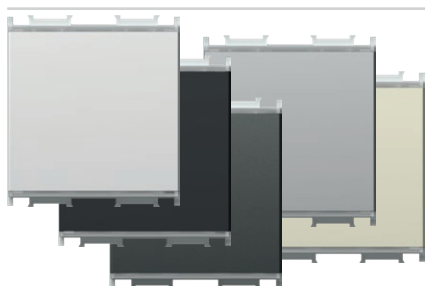

- EM26PW
- EM26SB
- EM26AT
- EM26ES
- EM26IW

**NJËSI KONTROLLI ME BUTON ME SHTYPJE 2M**

- e lidhur me reostatin universal EM25 lejon kontrollimin e llambave me të njëjtin funksionim (deri) si EM25
- tensioni i furnizimit, 230 V ~ 50 Hz
- në përputhje me standardet EN 60669-1 dhe EN 60669-2-1
- kontaktet e vidave 1,5 mm<sup>2</sup> (maks. e shtrengimit 0,4 Nm)

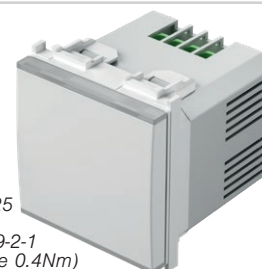

**PUSH-BUTTON CONTROL UNIT 2M**

- connected to universal dimmer EM25 allows controlling of lamps with same functionality as EM25
- supply voltage 230V ~ 50Hz
- in accordance with EN 60669-1 and EN 60669-2-1
- screw contacts 1.5mm<sup>2</sup> (max. tightening torque 0.4Nm)

(1) lidhje me dy tela  
two-wire connection

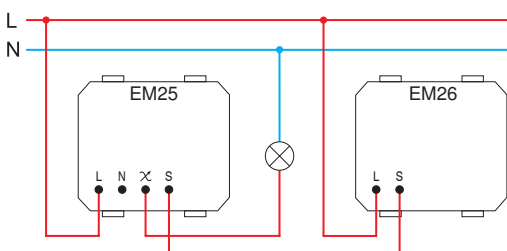

- lidhja me dy tela lejon uljen e ndriçimit të llambave me ulje ndriçimi
- në një lidhje me dy tela secila njësi shtesë kontrolli rrit ngarkesën minimale me 25 W

- two-wire connection allows dimming of dimmable lamps
- in a two-wire connection each additional control unit increases the minimum load by 25W

(2) lidhje me tre tela  
three-wire connection

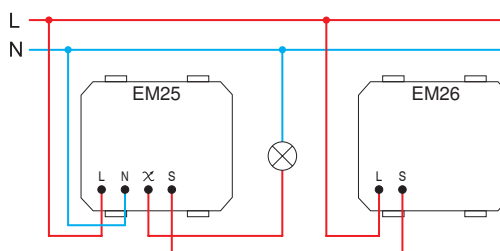

- lidhja me tre tela lejon uljen e ndriçimit të llambave me ulje ndriçimi dhe disa pa ulje ndriçimi dhe llambave CFL

- three-wire connection allows dimming of dimmable lamps and some of non-dimmable LED and CFL lamps



EM27

**FILTRI I FREKUENCËS**

- filtri i frekuencës për EM25
  - imazhi është simbolik
- FREQUENCY FILTER**
- frequency filter for EM25
  - image is symbolic

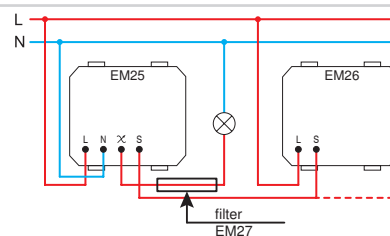

**SET ÇELËS / REOSTAT UNIVERSAL RLC 0-300W 2M PP OL20**

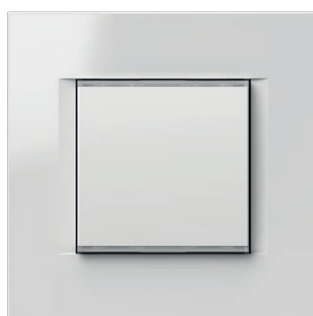

□ EM25PPOL20

- seti përfshin reostatin EM25, komizën e montimit 2M dhe kapakun mbulues LINE 2M PW
- për detaje teknike shikoni EM25

**SET SWITCH / DIMMER UNIVERSAL RLC 0-300W 2M PP OL20**

- set includes dimmer EM25, mounting frame 2M and cover plate LINE 2M PW
- for technical details see EM25



2M = 45 x 45

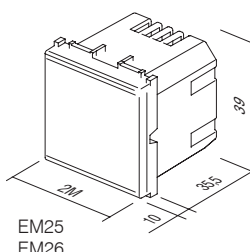

EM25  
EM26

### ÇELËS IR 5A 230V~ 1M



- EM31PW
- EM31SB
- EM31AT
- EM31ES
- EM31IW

- çelës IR me infra të kuqe
- tensioni i furnizimit: 230 V~ ±10 % 50 Hz
- rele: 5 A / 250 V~ (zero kryqëzim)
- vlerësimi i mbrojtjes: IP40
- preja e tërthortë e telave në kontakt 0,75 - 2,5 mm<sup>2</sup>
- zona e zbulimit: deri në 110° në 20°C
- zona e zbulimit: rreth 8 m në 20°C
- rregullimi i kohëzgjatjes: nga rreth 5 sek. në 12 min.
- rregullimi i ndriçimit: nga rreth 5 deri 200 LUX
- temperatura e funksionimit: nga 0°C në +40°C
- i papërshtatshëm për instalim në kuti me thellësi 45 mm dhe kuti montimi në sipërfaqe CUBO IP20
- vetëm për përdorim të brendshëm



### IR SWITCH 5A 230V~ 1M

- IR infrared switch
- supply voltage: 230V~ ±10 % 50Hz
- relay: 5A / 250V~ (zero crossing)
- protection rating: IP40
- cross-section of wires at the contact terminal: 0.75 - 2.5 mm<sup>2</sup>
- detection angle: up to 110° at 20°C
- detection area: approx. 8 m at 20°C
- adjustability of duration: from approx. 5 s to 12 min
- adjustability of brightness: from approx. 5 to 200 LUX
- operating temperature: from 0°C to +40°C
- not suitable for installation in 45 mm deep boxes and surface mount box CUBO IP20
- only for indoor usage

### ÇELËS IR 5 A 230 V~ 2M

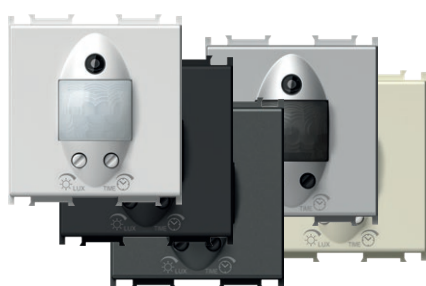

- EM32PW
- EM32SB
- EM32AT
- EM32ES
- EM32IW

- çelës IR me infra të kuqe
- tensioni i furnizimit: 230 V~ ±10 % 50 Hz
- rele: 5 A / 250 V~ (zero kryqëzim)
- vlerësimi i mbrojtjes: IP40
- preja e tërthortë e telave në kontakt 0,75 - 2,5 mm<sup>2</sup>
- zona e zbulimit: deri në 110° në 20°C
- zona e zbulimit: rreth 8 m në 20°C
- rregullimi i kohëzgjatjes: nga rreth 5 sek. në 12 min
- rregullimi i ndriçimit: nga rreth 5 deri 200 LUX
- temperatura e funksionimit: nga 0°C në +40°C
- i papërshtatshëm për instalim në kuti me thellësi 45 mm dhe kuti montimi në sipërfaqe CUBO IP20
- vetëm për përdorim të brendshëm



### IR SWITCH 5A 230V~ 2M

- IR infrared switch
- supply voltage: 230V~ ±10 % 50Hz
- relay: 5A / 250V~ (zero crossing)
- protection rating: IP40
- cross-section of wires at the contact terminal: 0.75 - 2.5 mm<sup>2</sup>
- detection angle: up to 110° at 20°C
- detection area: approx. 8 m at 20°C
- adjustability of duration: from approx. 5 s to 12 min
- adjustability of brightness: from approx. 5 to 200 LUX
- operating temperature: from 0°C to +40°C
- not suitable for installation in 45 mm deep boxes and surface mount box CUBO IP20
- only for indoor usage

gama e zbulimit /  
detection range

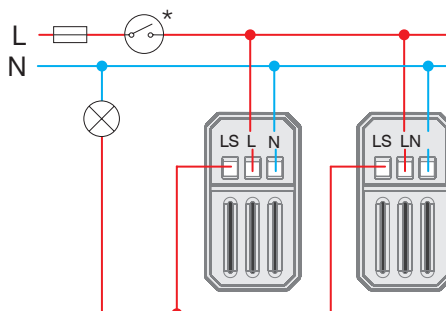
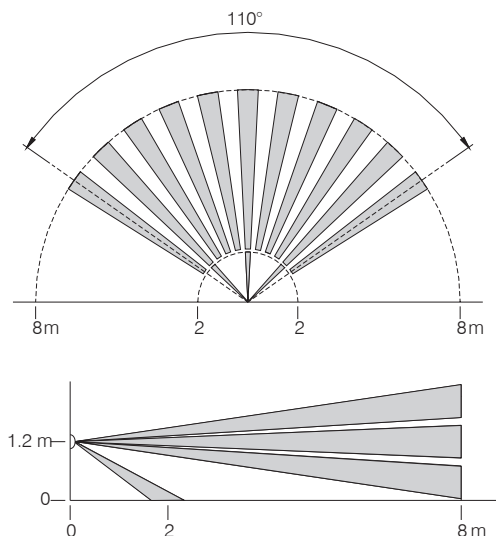

E L E C T R O N I C S E M

koha dhe rregullimi për muzgun /  
time and twilight adjustment

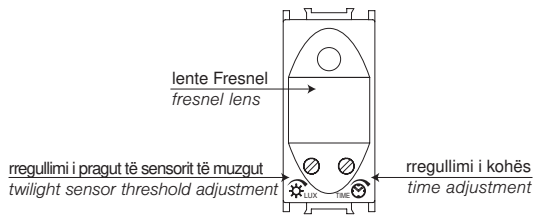

5 LUX	~5 s	200 LUX
		~12 min

	1	2	3	4	5	6	7	8
Min.	1 W	1 W		1 VA	1 W	1 W	1 VA	1 VA
Max.	800 W	800 W	5A	6x20 VA	6x36 W	4x36 W (20µF)	6x23 VA	6x20 VA

1 - llambë inkandeshente /  
incandescent lamp

2 - llambë halogjene /  
halogen lamp

3 - element ngrohjeje me rezistencë /  
resistive heating element

4 - transformator elektrik /  
electronic transformer

5 - llambë neoni fluoreshente (versioni 1) /  
fluorescent tube (version 1)

6 - llambë neoni fluoreshente (versioni 2) /  
fluorescent tube (version 2)

7 - llambë CLF me kursim energjie /  
energy saving CFL lamp

8 - llambë LED /  
LED lamp

kujdes /  
attention

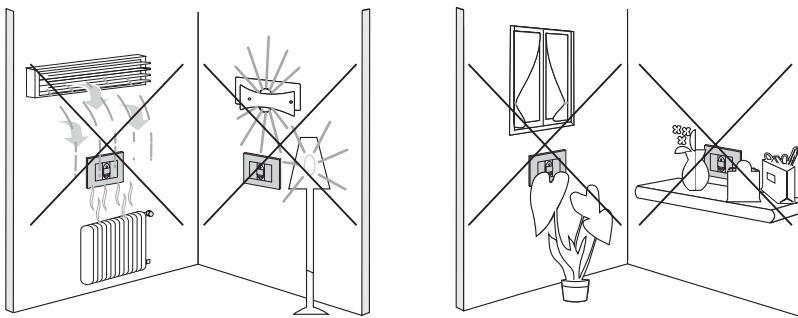

1M = 22,5 x 45

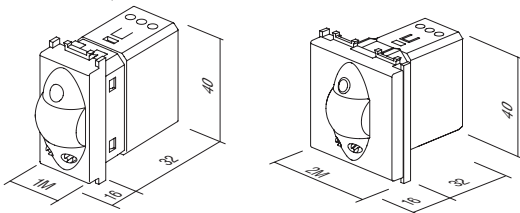

TERMOSTAT BAZË 6 A 230 V ~ 2M



- EM37PW
- EM37SB
- EM37AT
- EM37ES
- EM37IW

- termostat elektronik, bazë
- regjimi i funksionimit: ngrohje/ftohje/fikje
- tensioni i furnizimit: 230 V AC, 50 Hz
- dalja: 6(2) A, 230 V AC, çelësi i relesë
- gama e rregullimit: +10 °C deri +30 °C
- histereza: ±0,5 °C, ED = 20 min
- mbrojtja kundër ngrirjes (regjimi i ngrohjes): +6 °C
- mbrojtja nga mbinxehja (regjimi i ftohjes): +32 °C
- funksioni ECO për uljen e temperaturës me 3 °C për 6 orë në regjimin e ngrohjes dhe rritjen e temperaturës me 3 °C për 6 orë në regjimin e ftohjes
- funksioni përshtatës ECO, automatikisht çdo ditë në të njëjtën orë ul temperaturën me 3 °C për 6 orë në regjimin e ngrohjes dhe e rrit temperaturën me 3 °C për 6 orë në regjimin e ftohjes
- opsioni për të aktivizuar regjimin e funksionimit ECO me aktivizim të jashtëm përmes një hyrjeje të veçantë
- treguesi LED i funksionimit
- i papërshatshëm për ngrohje elektrike nga dyshemeja
- kontaktet e vidave maks. 2,5 mm<sup>2</sup>
- në përputhje me Direktivën LV, Direktivën EMC, standardet EN60730-1 dhe EN60730-2-9
- për funksionim të saktë, rekomandojmë instalimin e një kutie të pavarur, të ndarë nga pajisjet që gjenerojnë nxehtësi
- temperatura e funksionimit: 5 ÷ 35 °C
- temperatura e magazinimit: -20 ÷ 50 °C



Termostati është i destinuar për rregullimin e temperaturës në dhomë. Termostati mundëson dy regjime funksionimi - ngrohje ose ftohje. Ai ka funksione sigurie të instaluar për mbrojtje kundër ngrirjes (regjimi i ngrohjes) dhe mbrojtje kundër mbinxehjes (regjimi i ftohjes). Funksionimi tregohet përmes dritave LED. Konfigurimi i termostatit kryhet me ndihmën e një butoni rrotullues për caktimin e temperaturës dhe me butona të tjerë me prekje kapacitive.

The thermostat is intended for regulating temperature in a room. A thermostat enables two modes of operation – heating or cooling. It has safety functions installed for protection against freezing (heating mode) and protection against overheating (cooling mode). The operation is indicated via LED lights. Thermostat setup is performed with the help of a rotary button for setting the temperature and with other capacitive touch buttons.

THERMOSTAT BASIC 6A 230 V ~ 2M

- electronic thermostat, basic
- operation mode: heating/cooling/turn off
- power supply: 230 VAC, 50 Hz
- output: 6(2) A, 230 VAC, relay switch
- regulation range: +10 °C to +30 °C
- hysteresis: ±0.5 °C, ED = 20min
- anti-freeze protection (heating mode): +6 °C
- overheating protection (cooling mode): +32 °C
- ECO function for lowering the temperature by 3 °C for 6 hours in the heating mode and raising temperature by 3 °C for 6 hours in the cooling mode
- adaptive ECO function, automatically every day at the same time lowers the temperature by 3 °C for 6 hours in the heating mode and raises temperature by 3 °C for 6 hours in the cooling mode
- option to turn on the ECO operating mode by external trigger via a separate input
- LED indication of operation
- not suitable for electrical floor heating
- screw contacts max. 2.5 mm<sup>2</sup>
- in accordance with the LV Directive, the EMC Directive, standards EN60730-1 and EN60730-2-9
- for correct operation, we recommend installing in an independent single box, separate from devices that generate heat
- operating temperature: 5 ÷ 35 °C
- storage temperature: -20 ÷ 50 °C

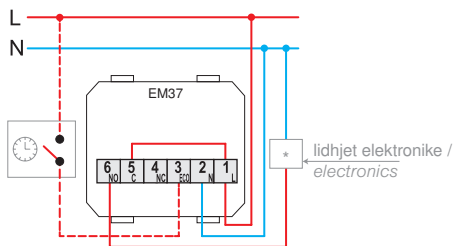

pompa e qarkullimit, vatra (lidhja direkte), transmision termoelektrik / circulation pump, burner (direct connection) thermoelectric drive

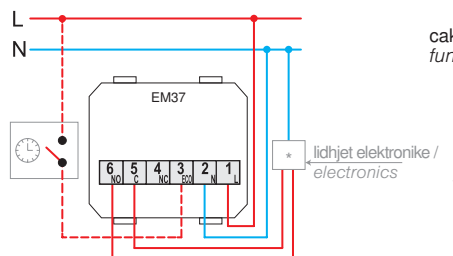

bojleri, pompa e nxehtësisë, vatra (hyrja e kontrollit T1/T2) / boiler, heat pump, burner (control input T1/T2)

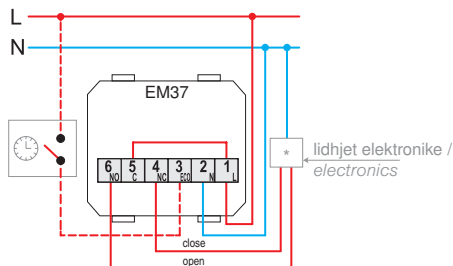

transmisioni me motor (përdorim i kufizuar me ngrohje nën dysheme) / motor drive (limited use with underfloor heating)

caktimi i funksionit në temperaturë / function and temperature adjustment

butoni i përzgjedhjes së funksioneve dhe treguesit i statusit të LED-it:  
 e kuqe: ngrohje  
 blu: kondicioner  
 pa ndriçim: e fikur

function selection button and LED status indicator:  
 red: heating  
 blue: air conditioning  
 no light: switched off

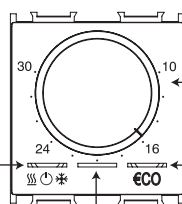

caktimi i funksionit të temperaturës / temperature setting

butoni i përzgjedhjes së funksioneve "ECO" dhe treguesit të statusit "ECO" të LED-it e gjelbër: kursimi i energjisë ECO aktiv portokalli: regjimi ECO adaptiv i aktivizuar pa ndriçim: regjimi i ditës

"ECO" function selection button and LED "ECO" status indicator  
 green: ECO energy saving ON  
 orange: adaptive ECO mode activated  
 no light: day mode

treguesi LED i gjendjes së relesë së daljes e bardhë: releja e ndezur pa ndriçim: releja e fikur

LED output relay state indicator  
 white: relay ON  
 no light: relay OFF

kujdes / attention

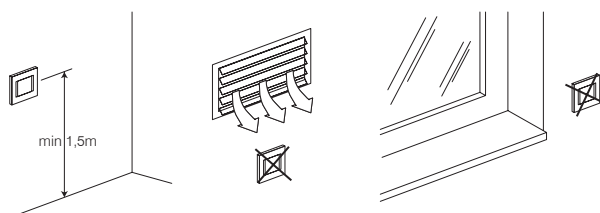

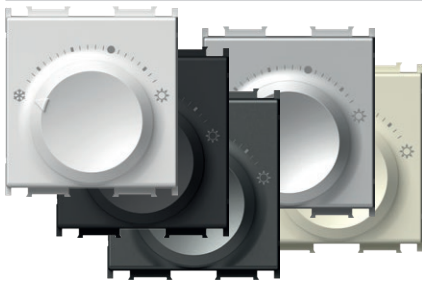

- EM38PW
- EM38SB
- EM38AT
- EM38ES
- EM38IW

**TERMOSTATI I NGROHJES 5(2)A 230V~ 2M**

- mënyra e funksionimit: ftohje
- furnizimi me energji elektrike: 230 V AC, 50 Hz
- impulsi i tensionit: 4 kV
- konsumi i energjisë: < 0,5 W
- prodhimi: 2 A (maksimumi 5 A); 230 V AC, 50 Hz
- dalja e ndërrimit: NO (maksimumi 10 aktivizues)
- gama e rregullimit: +5°C deri +30°C
- mbrojtja nga ngricat: +5°C
- histereza: 0,5 K
- mbrojtja: IP30
- lloji i sensorit: Bimetal
- lloji i lidhjes elektrike: kontakte me susta
- lloji i përcjellësve: 0,75 - 1,5 mm<sup>2</sup> (bërthama fleksibël me fije); 1,0 - 2,5 mm<sup>2</sup> (bërthama e fortë)
- në përputhje me direktivën DIN EN 60730



*HEATING THERMOSTAT 5(2)A 230V~ 2M*

- operation mode: heating
- power supply: 230 VAC, 50 Hz
- voltage pulse: 4 kV
- energy consumption: < 0.5 W
- output: 2 A (max. 5 A); 230 VAC, 50 Hz
- switching output: NO (max. 10 actuators)
- regulation range: +5°C to +30°C
- frost protection: +5°C
- hysteresis: 0.5 K
- protection: IP30
- sensor type: Bimetal
- type of electrical connection: Spring-loaded contacts
- type of conductors: 0.75 – 1.5 mm<sup>2</sup> (flexible-stranded core); 1.0 – 2.5 mm<sup>2</sup> (solid core)
- in compliance with Directive DIN EN 60730

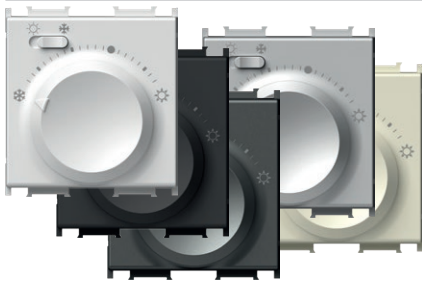

- EM39PW
- EM39SB
- EM39AT
- EM39ES
- EM39IW

**TERMOSTAT NGROHJEJE/FTOHJEJE 3(1,5)A 230V~ 2M**

- mënyra e funksionimit: ftohje/ngrohje
- furnizimi me energji elektrike: 230 V AC, 50 Hz
- impulsi i tensionit: 4 kV
- konsumi i energjisë: < 0,5 W
- prodhimi: 1.5 A (maksimumi 3 A); 230 V AC, 50 Hz
- dalja e ndërrimit: çelësi i zgjedhjes së modalitetit (maksimumi 5 aktivizues)
- gama e rregullimit: +5°C deri +30°C
- mbrojtja nga ngricat: +5°C
- histereza: 0,5 K
- mbrojtja: IP30
- lloji i sensorit: Bimetal
- lloji i lidhjes elektrike: kontakte me susta
- lloji i përcjellësve: 0,75 - 1,5 mm<sup>2</sup> (bërthama fleksibël me fije); 1,0 - 2,5 mm<sup>2</sup> (bërthama e fortë)
- në përputhje me direktivën DIN EN 60730



*HEATING/COOLING THERMOSTAT 3(1.5)A 230V~ 2M*

- operation mode: cooling/heating
- power supply: 230 VAC, 50 Hz
- voltage pulse: 4 kV
- energy consumption: < 0.5 W
- output: 1 A (max. 3 A); 230 VAC, 50 Hz
- switching output: mode selector switch (max. 5 actuators)
- regulation range: +5°C to +30°C
- frost protection: +5°C
- hysteresis: 0.5 K
- protection: IP30
- sensor type: Bimetal
- type of electrical connection: Spring-loaded contacts
- type of conductors: 0.75 - 1.5mm<sup>2</sup> (flexible-stranded core); 1.0 - 2.5 mm<sup>2</sup> (solid core)
- in compliance with the Directive DIN EN 60730

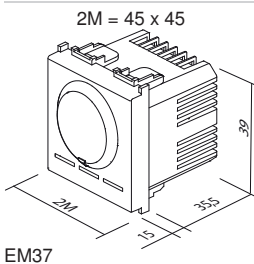

EM37

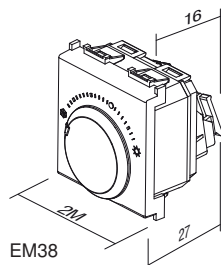

EM38

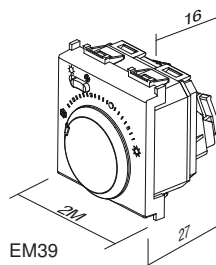

EM39



NM39

### KORNIZË MONTIMI ME VIDA PËR TERMOSTATE FANTINI COSMI 3M

- kornizë montimi me vida për termostate Fantini Cosmi 3M
- i përshtatshëm për përdorim me modelet e përditshme të termostateve Fantini Cosmi CH121 dhe CH123
- i përshtatshëm për përdorim me modelet javore të termostateve Fantini Cosmi CH141A dhe CH143A
- për montim në kutitë drejtkëndore 3M
- i përshtatshëm për montimin me kapakët mbulues PURE, Line, Soft



#### MOUNTING FRAME WITH SCREWS FOR FANTINI COSMI THERMOSTATS 3M

- mounting frame with screws for Fantini Cosmi thermostats 3M
- suitable for use with Fantini Cosmi daily thermostats models CH121 and CH123
- suitable for use with Fantini Cosmi weekly thermostats models CH141A and CH143A
- for mounting in rectangular boxes 3M
- suitable for assembling with cover plates PURE, Line, Soft



- EM40PW
- EM40SB
- EM40AT
- EM40ES
- EM40IW

### ÇELËSI I KARTËS SË KURSIMIT TË ENERGJISË 3 A 250 V~ 3M

- çelës karte bazë, çdo kartë ISO
- tensioni i furnizimit, 230 V ~ 50 Hz
- dalja 3 A 250 V~ për kontaktorin e çelësit \*
- vonesa e fikjes 15-20 sek.
- në përputhje me EN 61000-6-1
- karta nuk është e përfshirë
- jo për kontrollin e aksesit



#### ENERGY SAVER CARD SWITCH 3A 250V~ 3M

- card switch basic, any ISO card
- supply voltage 230V~ 50Hz
- output 3A 250V~ for switching contactor \*
- switch off delay 15-20s
- in accordance with EN 61000-6-1
- card is not included
- not for access control

3M = 67,5 x 45

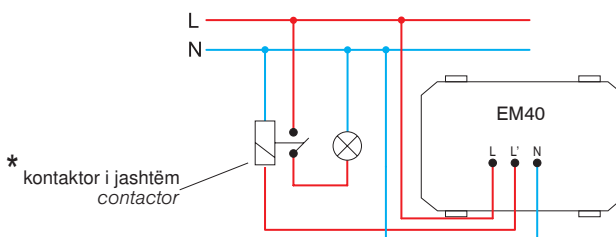
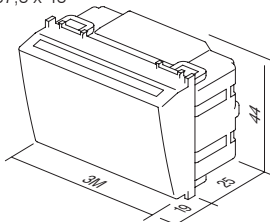

### KARTË ISO

EM47

- kartë ISO
- për kombinim me çelës karte EM40
- madhësia: 85x54 mm

#### CARD ISO

- ISO card
- for combination with card switch EM40
- size: 85x54 mm

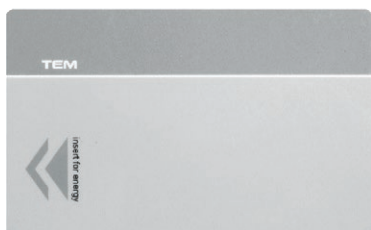





EM44BK

**ÇELËS KARTE PËR KURSIM TË ENERJISË RF HF 13,56 MHz 3M**

- çelës kartë elektronike për kartë RFID ISO
- furnizimi nga njësia e rele së EM49 përmes konektorëve të kabllove RJ12
- dalja të lidhet me njësinë e daljes së rele së EM49
- vonesë 15-20 sek. e çelësit "kryesor të energjisë" me heqjen e kartës
- vonesë 1 min. e çelësit "HVAC" me heqjen e kartës kur hapen dyert ose dritaret e ballkonit
- në përputhje me EN 61000-6-1
- karta nuk është e përfshirë
- jo për kontrollin e aksesit

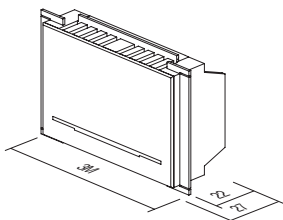
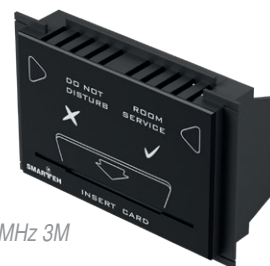

**ENERGY SAVER CARD SWITCH RF HF 13,56MHz 3M**

- electronic card switch for RFID ISO card
- supply from relay unit EM49 through cable connectors RJ12
- output to be connected to relay output unit EM49
- 15-20s "main power" switch off delay with card withdrawal
- 1 min "HVAC" switch off delay with card withdrawal when balcony doors or windows opened
- in accordance with EN 61000-6-1
- card is not included
- not for access control

**NJËSIA E KONTROLLIT TË KURSIMIT TË ENERJISË 2x16 A 250 V~**

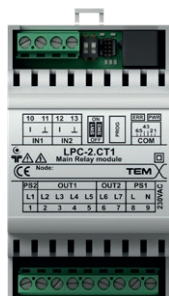

EM49

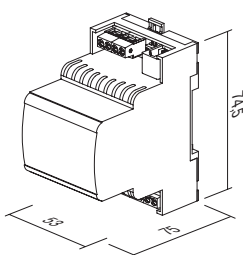

- njësi releje për çelësat e kartës EM44
- tensioni i furnizimit, 230 V ~ 50 Hz
- në përputhje me EN 61000-6-1
- montim në shinë DIN 35 mm, 3MU
- hyrje dhe dalje në varësi të implementimit: dhomë njëshe ose dyshë

**ENERGY SAVER CONTROL UNIT 2x16A 250V~**

- relay unit for card switches EM44
- supply voltage 230V~ 50Hz
- in accordance with EN 61000-6-1
- mounting on DIN rail 35mm, 3MU
- input and output depending on implementation: single or double room



**SHPERNDARËS SPL-1**

EM45



- përdoret për të lidhur dy module periferike EM44 me njësinë e rele së EM49
- konektori i komunikimit RJ12
- madhësia: 37 x 30 x 27 mm

**SPLITTER SPL-1**

- used to connect two peripheral modules EM44 to relay unit EM49
- communication connector RJ12
- size: 37 x 30 x 27 mm

skema e instalimeve elektrike për implementim në dhomë njëshe / wiring diagram for single room implementation

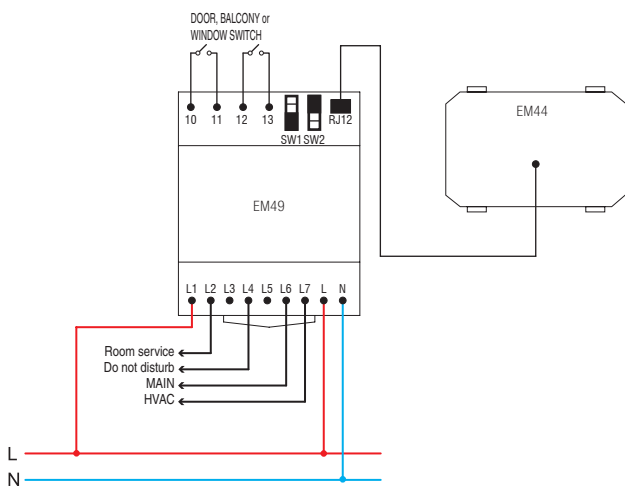

skema e instalimeve elektrike për implementim në dhomë dyshë / wiring diagram for double room implementation

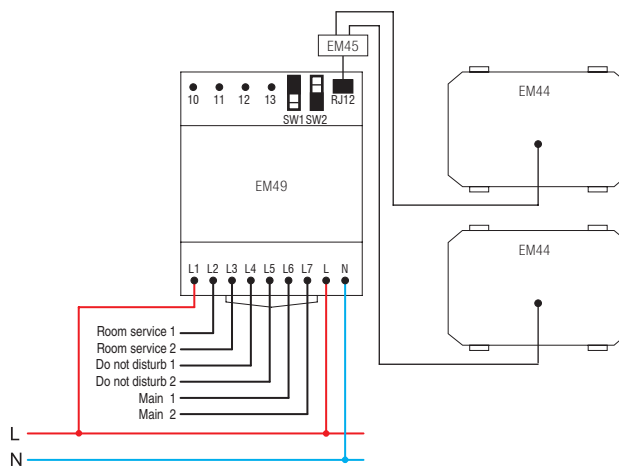

kabloja e lidhjes RJ12 mes EM44 dhe EM49 / connection cable RJ12 between EM44 and EM49

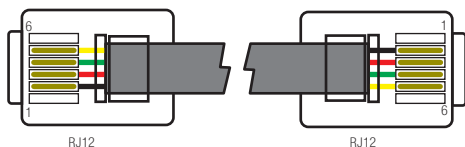

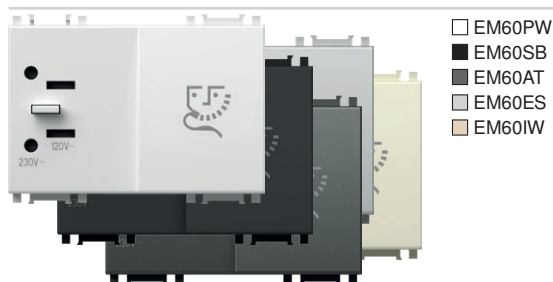

- EM60PW
- EM60SB
- EM60AT
- EM60ES
- EM60IW

### PRIZË PËR RROJË 230 V~/120 V~ 3M

- njësi furnizimi për rojë me transformator izolues 20 VA
- furnizimi: 230 V~ 50-60 Hz
- dalja:
- 230 V~ për 2P 2,5 A spinë Euro ose
- 120V~ për 2P 15 A spinë amerikane
- Klasi II
- në përputhje me EN 61558-2-5

### SOCKET SHAVER 230V~/120V~ 3M

- shaver supply unit with isolating transformer 20VA
- supply: 230V~ 50-60Hz
- output:
- 230V~ for 2P 2.5A Europlug or
- 120V~ for 2P 15A American plug
- Class II
- in accordance with EN 61558-2-5

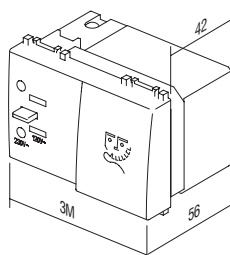

3M = 67,5 x 45

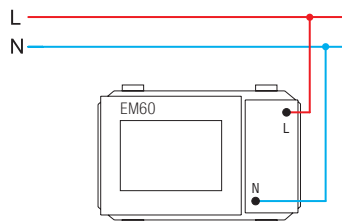

- EM67PW
- EM67SB
- EM67AT
- EM67ES
- EM67IW

### NJËSIA E FURNIZIMIT ME ENERGI USB 5 V 2,1 A 1M

- për karikimin e pajisjeve elektronike përmes një porte standarde USB (e përputhshme gjithashtu edhe me pajisjet Apple)
- furnizimi me energji: 100-230 V~ 50/60 Hz
- konsumi i energjisë:
- 300 mA në 100 V~/150 mA në 230 V~
- konsumi i energjisë në gatishmëri: 30mW në 230 V~
- tensioni nominal në dalje: 5 VDC (±5 %) SELV
- tensioni i ondulacionit në dalje: 150 mV
- rryma nominale në dalje: 2,1 A (1 x 2100 mA) (±10 %)
- efikasiteti: maksimumi 77%
- temperatura e funksionimit: 0°C/+45°C (përdorimi i brendshëm)
- Klasi mbrojtës IP: IP20, vetëm për përdorim në ambiente të brendshme
- klasi i pajisjes II
- kategoria e mbritensionit (EN 62109): klasi III
- kontaktet e vidave: maks. 2,5 mm<sup>2</sup>
- pajisje me hapësirë kontakti prej të paktën 3 mm
- në përputhje me standardet EN 60950-1 dhe Direktivës LVC dhe EMC

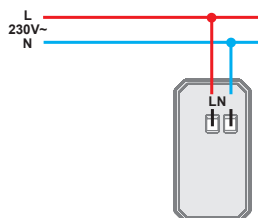
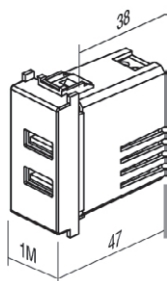

### USB POWER SUPPLY UNIT 5V 2.4A 1M

- for charging of electronic devices via a standard USB port (also compatible with Apple devices)
- power supply: 100-230V~ 50/60Hz
- power consumption: 300mA at 100V~/150mA at 230V~
- standby power consumption: 30mW at 230V~
- nominal output voltage: 5 VDC (± 5%) SELV
- output ripple voltage: 150mV
- nominal output current: 2,4A (±10%)
- efficiency: maximum of 77%
- operating temperature: 0°C/+45°C (indoor use)
- IP protection class: IP20, indoor use only
- class device II
- overvoltage category (EN 62109): Class III
- screw contacts: max. 2.5 mm<sup>2</sup>
- device with a contact gap of at least 3mm
- in accordance with EN 60950-1 and LVD & EMC directives



- EM68PW
- EM68SB
- EM68AT
- EM68ES
- EM68IW

**NJËSIA E FURNIZIMIT ME ENERGJI USB 5 V 3,0 A**

- për karikimin e pajisjeve elektronike përmes një porte standarde USB (e përputhshme gjithashtu edhe me pajisjet Apple)
- furnizimi me energji: 100-230 V~ 50/60 Hz
- konsumi i energjisë: 300 mA në 100 V~/150 mA në 230 V~
- konsumi i energjisë në gatishmëri: 30mW në 230 V~
- tensioni nominal në dalje: 5 VCD (±5 %) SELV
- tensioni i ondulacionit në dalje: 150 mV
- rryma nominale në dalje: 3,0 A (±10%)
- lloji i konektorit: USB A / USB C
- efikasiteti: maksimumi 77%
- temperatura e funksionimit: 0°C/+45°C (përdorimi i brendshëm)
- klasi i mbrojtjes IP: IP20, vetëm për përdorim në ambiente të brendshme
- klasi i pajisjes II
- kategoria e mbtensionit (EN 62109): Klasi III
- kontaktet e vidave maks. 2,5 mm<sup>2</sup>
- pajisje me hapësirë kontakti prej të paktën 3 mm
- në përputhje me standardet EN 60950-1 dhe Direktivës LVC dhe EMC

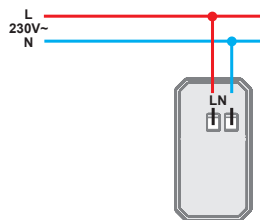
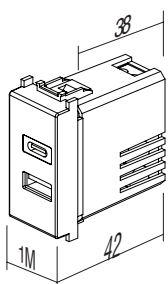

**USB POWER SUPPLY UNIT 5V 3,0A**

- for charging of electronic devices via a standard USB port (also compatible with Apple devices)
- power supply: 100-230V~ 50/60Hz
- power consumption: 300mA at 100V~/150mA at 230V~
- standby power consumption: 30mW at 230V~
- nominal output voltage: 5 VCD (± 5%) SELV
- output ripple voltage: 150mV
- nominal output current: 3,0 A (±10%)
- connector type: USB A / USB C
- efficiency: maximum of 77%
- operating temperature: 0°C/+45°C (indoor use)
- IP protection class: IP20, indoor use only
- class device II
- overvoltage category (EN 62109): Class III
- screw contacts: max. 2.5 mm<sup>2</sup>
- device with a contact gap of at least 3mm
- in accordance with EN 60950-1 and LVD & EMC directives

**DRITË EMERGJENCE LED 250 V~ 0,90 W, NiCd 3h 7M**



- EM55

- dritë emergjence LED
- tensioni i furnizimit 250 V~ 50 Hz 3x LED 0,3 W, 10000 mcd, 6500K
- akumulator NiCd 400 mAh, i ndërrueshëm
- autonomia 3 orë, karikimi 24h
- Klasi II
- në përputhje me standardet EN 60598-1, EN 60598-2-2, EN 60598-2-22



**LED EMERGENCY LIGHT 250V~ 0.90W, NiCd 3h 7M**

- emergency LED lamp
- supply voltage 250V~ 50Hz 3x LED 0,3W, 10000mcd, 6500K
- NiCd accumulator 400 mAh, replaceable
- autonomy 3h, charging 24h
- Class II
- in accordance with EN 60598-1, EN 60598-2-2, EN 60598-2-22

7M = 151,5 x 45

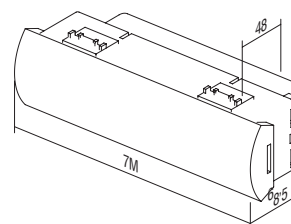
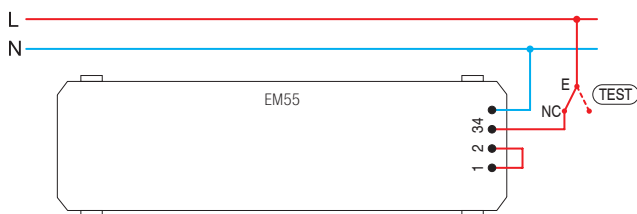

**DRITË EMERGJENCE LED 230 V~50 Hz, 0,5 W, NiMH 2 ORË 2M**



- EM57

- llambë emergjence LED
- opion për ta përdorur si llambë koke (mekanizmi me tërheqje)
- tensioni i furnizimit 230 V~50 Hz, 1xLED 0,5 W
- Akumulator NiMH 140 mAh, i zëvendësueshëm
- autonomia 2 orë, karikimi 36 orë
- klasi i pajisjes II
- në përputhje me standardet EN60598-1, EN60598-2-2, EN62471, EN55015:2006, EN61547

**LED EMERGENCY LIGHT 230V~50Hz, 0.5W, NiMH 2h 2M**

- emergency LED lamp
- option to use it as a hand lamp (pull-out mechanism)
- supply voltage 230V~ 50Hz, 1xLED 0.5W
- NiMH accumulator 140mAh, replaceable
- autonomy 2h, charging 36h
- class device II
- in accordance EN60598-1, EN60598-2-2, EN62471, EN55015:2006, EN61547

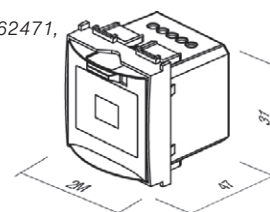
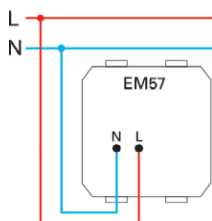
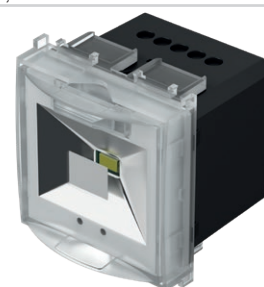

LLAMBË LED NJËNGJYRËSHE 250 V ~ 0,8 W 2M

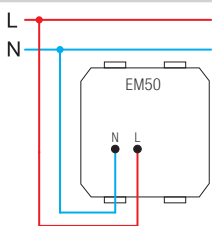
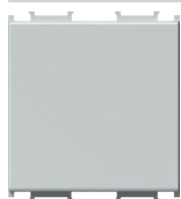

- EM50WH
- EM50BL
- EM50RD
- EM50GR

- llambë LED shënuese
- tensioni i furnizimit, 230 V ~ 50 Hz, 0,8 W, 6500K
- Klasi II
- në përputhje me EN 60598-1
- përdorim opsional për ndriçimin e drejtitim ose sinjalit me printim të personalizuar me lazer në difuzor

LED LAMP MONOCOLOR 250V~ 0,8W 2M

- step marker LED lamp
- supply voltage 230V~ 50Hz 0,8W, 6500K
- Class II
- in accordance with EN 60598-1
- optional usage for directional or signal illumination with customized laser printing on diffuser



LLAMBË LED ME DY NGJYRA 250 V ~ 2 x 0,4 W 2M

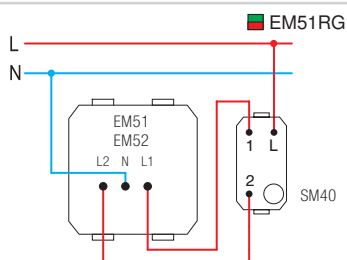

- EM51RG

- llambë LED sinjalizuese me dy ngjyra (e kuqe/e gjelbër)
- tensioni i furnizimit, 230 V ~ 50 Hz, 0,8 W, 6500K
- Klasi II
- në përputhje me EN 60598-1
- difuzori përfshin grafikët siç tregohet
- mundësi për printim të personalizuar me lazer në difuzor

LED LAMP DUAL COLOR 250V~ 2x0,4W 2M

- signaling dual color (red/green) LED lamp
- supply voltage 230V~ 50Hz 2x0,4W, 6500K
- Class II
- in accordance with EN 60598-1
- diffuser includes graphics as shown
- possible customized laser printing on diffuser



LLAMBË LED 3D ME DY NGJYRA 250 V ~ 2 x 0,4 W 2M

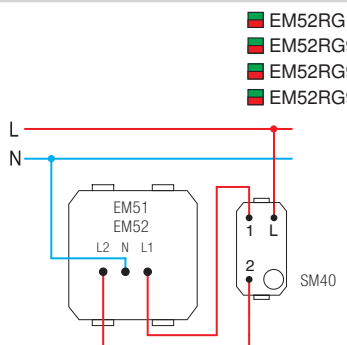

- EM52RG
- EM52RG90
- EM52RG91
- EM52RG99

- llambë LED sinjalizuese me dy ngjyra (e kuqe/e gjelbër) me simbol 3D
- tensioni i furnizimit, 230 V ~ 50 Hz, 0,8 W, 6500K
- Klasi II
- në përputhje me EN 60598-1
- mundësi për grafikë të personalizuar sipas kërkesës
- 90 simbol mashkull, 91 simbol femër, 99 simbol sipas kërkesës

LED LAMP 3D DUAL COLOR 250V~ 2x0,4W 2M

- signalling LED lamp, dual color (red/green) with 3D symbol
- supply voltage 230V~ 50Hz 2x0,4W, 6500K
- class II
- in accordance with EN 60598-1
- possible customized graphics on request
- 90 male symbol, 91 female symbol, 99 symbol on request

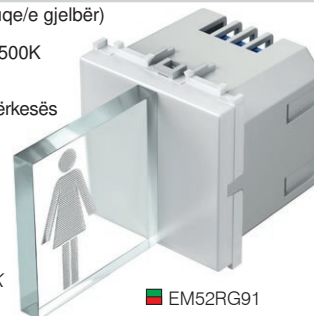

EM52RG91

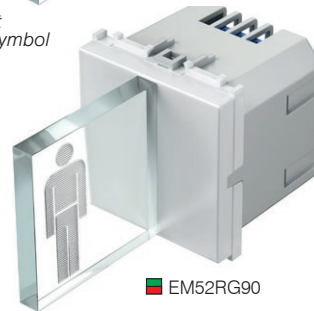

EM52RG90

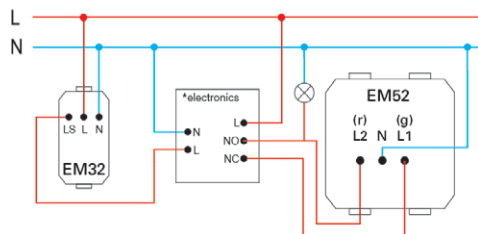

2M = 45 x 45

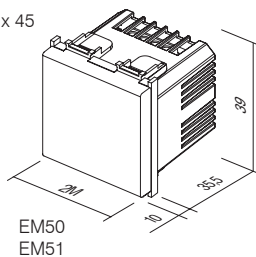

EM50  
EM51

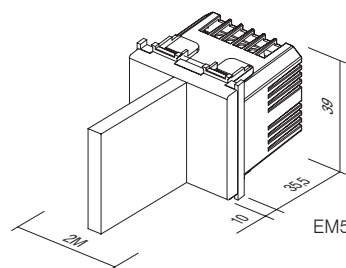

EM52

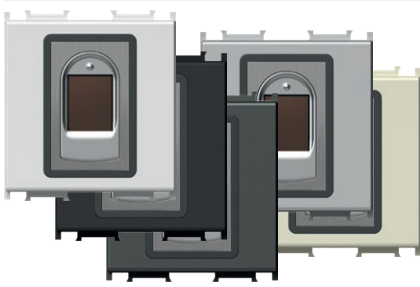

- EM71PW
- EM71SB
- EM71AT
- EM71ES
- EM71IW

**ÇELËS ME GJURMË GISHTI BIOPASS 2M**

- çelës me gjurmë gishti me njësi releje të brendshme dhe furnizim me energji
- Kapaciteti: 500 gjurmë gishtash
- Menaxhim i lehtë përmes aplikacionit për celular X-Manager
- Tensioni i furnizimit me energji: 8-30 V – DC ose AC (përfshihet furnizimi me energji)
- Sensor me prekje kapacitative
- Rele me 2 dalje
- Tensioni/rryma maksimale në rele: 40 V/3 A
- Koha e aktivizimit të relesë: 1-10 sek.
- Fuqia maksimale: 3,6 W
- lidhje e enkriptuar 256-bit mes çelësit dhe njësisë së relesë së brendshme
- Seti përfshin gjithashtu kornizën e montimit NM24 dhe pllakën e kapakut dekorativ OS20.

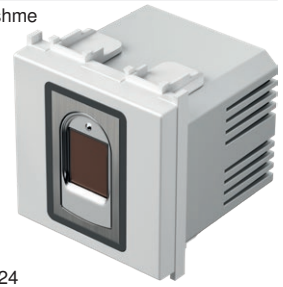

**FINGERPRINT SWITCH BIOPASS 2M**

- fingerprint switch with included internal relay unit and power supply
- capacity: 500 fingerprints
- easy management via X-Manager mobile app
- power supply voltage: 8-30V – DC or AC (power supply included)
- capacitive sensor
- 2 output relays
- maximum voltage/current on relay: 40V/3A
- relay triggering time: 1-10 sec
- maximum power: 3.6W
- 256-bit encrypted link between switch and internal relay unit
- Set also includes NM24 mounting frame and OS20 decorative cover plate.

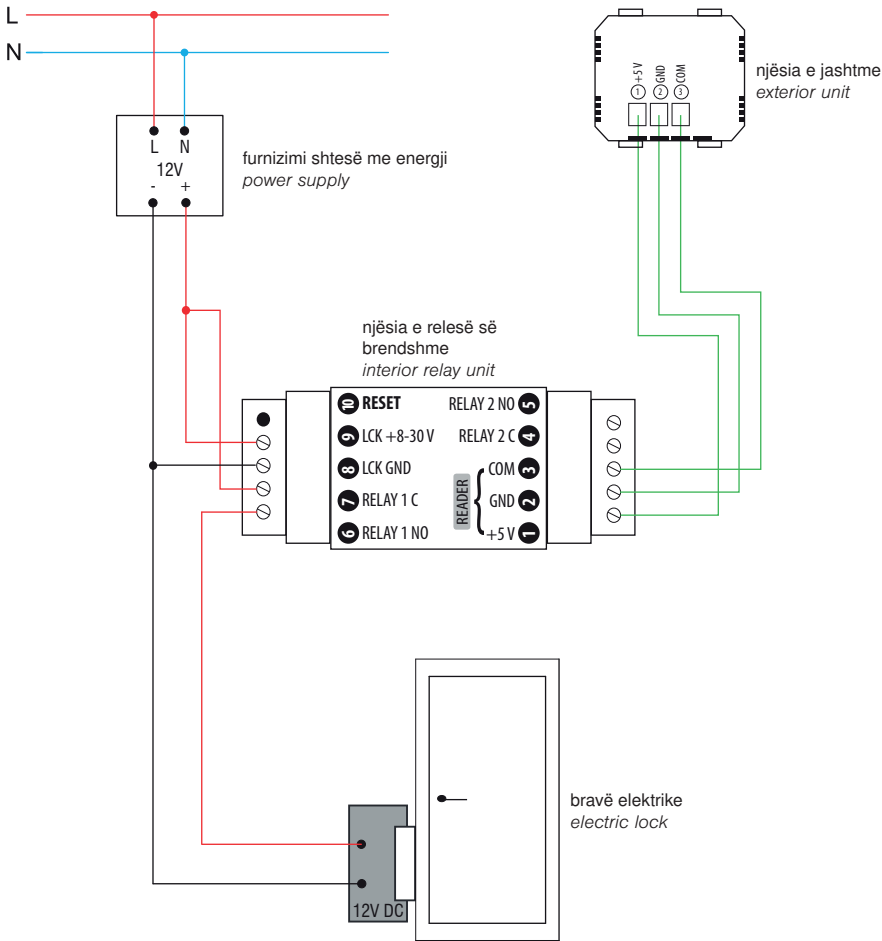

**X-Manager app**



support.tem.si



njësia e jashtme  
exterior unit

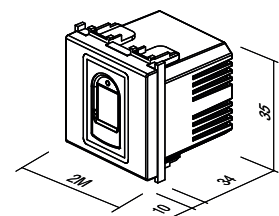

### ÇELËS, PA PREKJE 10 A 240 V~



■ EM80GW

- çelës pa prekje për ndezje/fikje ("master")
- furnizimi me energji: 240 V~ 50 Hz
- releja e daljes 10 A / 250 V~ (2400 W në 240 V~)
- gama e rregullueshme nga 2 deri 10 cm
- për instalimin në kuti të rumbullakët standarde Ø60 mm
- për lidhjen kërkohet një tel nul (N)
- nuk është e mundur lidhja me çelës me 2 drejtime
- është e mundur lidhja me deri në 5 çelësa kontrolli EM81
- instalim i lehtë i kapakëve dekorativë me ndihmën e magnetëve
- shtrëngimi i vidave të telave deri në 2,5 mm<sup>2</sup> (maks. forca e shtrëngimit të vidës është 0,4 Nm)
- në përputhje me standardet EN 60669-1 dhe EN 60669-2-1
- vetëm për përdorim të brendshëm



#### SWITCH, TOUCHLESS 10A 240V~

- touchless switch for turning on/off ("master")
- power supply: 240 V~ 50 Hz
- output relay 10A / 250V~ (2400W at 240V~)
- adjustable range from 2 to 10 cm
- intended for installation into a standard round Ø60 mm box
- a neutral lead (N) is required for connection
- connection with toggle switches is not possible
- connection with up to 5 EM81 control switches is possible
- simple installation of decorative covers with the help of magnets
- screw fastening of leads up to 2,5 mm<sup>2</sup> (max. screw tightening torque is 0.4 Nm)
- in accordance with EN 60669-1 and EN 60669-2-1
- only for indoor use

### ÇELËS, PA PREKJE, NJËSI KONTROLLI



■ EM81GW

- çelësi i kontrollit ("slave")
- funksionon vetëm kur lidhet me çelësin EM80 ("master")
- gama e rregullueshme nga 2 deri 10 cm
- instalim i lehtë i kapakëve dekorativë me ndihmën e magnetëve
- shtrëngimi i vidave të telave deri në 2,5 mm<sup>2</sup> (forca maks. e shtrëngimit të vidës është 0,4 Nm)
- në përputhje me standardet EN 60669-1 dhe EN 60669-2-1
- vetëm për përdorim të brendshëm



#### SWITCH, TOUCHLESS, CONTROL UNIT

- control switch ("slave")
- works only when connected with the EM80 switch ("master")
- adjustable range from 2 to 10 cm
- simple installation of decorative covers with the help of magnets
- screw fastening of leads up to 2,5 mm<sup>2</sup> (max. screw tightening torque is 0.4 Nm)
- in accordance with EN 60669-1 and EN 60669-2-1
- only for indoor use

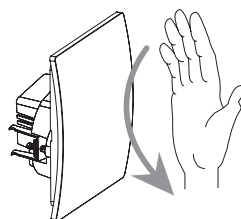
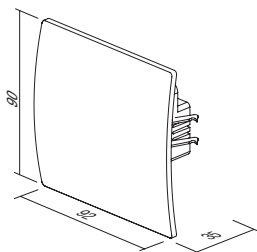
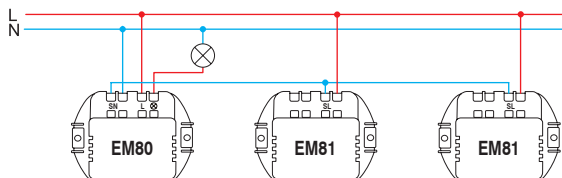
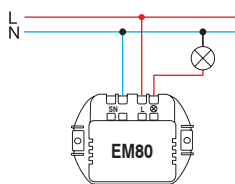

SINJALIZUES 8 VA 12V~1M

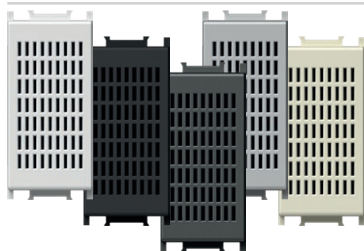

- EM91PW
- EM91SB
- EM91AT
- EM91ES
- EM91IW

- sinjalizues
- dalja e tingullit ka të njëjtën kohëzgjatje si funksionimi i kontrollit
- tensioni i furnizimit, 230V ~ 50 Hz 8 VA

*Buzzer 8VA 12V~1M*

- signal buzzer
- the sound emission has the same lasting time as the control operation
- supply voltage 12V~ 50Hz 8VA



ZILE 8 VA 12V~1M

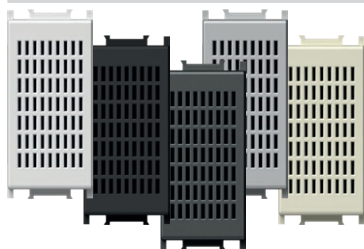

- EM93PW
- EM93SB
- EM93AT
- EM93ES
- EM93IW

- zile sinjalizuese
- dalja e tingullit ka të njëjtën kohëzgjatje si funksionimi i kontrollit
- tensioni i furnizimit, 12V ~ 50 Hz 8 VA

*Bell 8VA 12V~1M*

- signal bell
- the sound emission has the same lasting time as the control operation
- supply voltage 12V~ 50Hz 8VA



ZILE 230V~ 6mA rms 1M

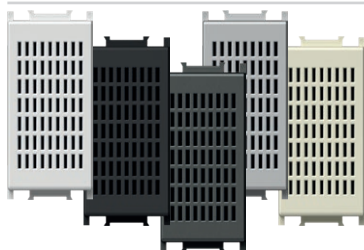

- EM94PW
- EM94SB
- EM94AT
- EM94ES
- EM94IW

- Furnizimi me energji elektrike 230 V ~ 50/60 Hz
- Konsumi i melodisë 1: 4,7 mA rms
- Konsumi i melodisë 2: 5,9 mA rms
- Niveli i tingullit të melodisë 1: 90,5 dB
- Niveli i tingullit të melodisë 2: 86 dB
- Temperatura e funksionimit nga: 0°C deri në 45°C (përdorim i brendshëm)
- Temperatura e magazinimit nga -20°C deri në 50°C
- Klasa e mbrojtjes IP: IP20 (vetëm për përdorim të brendshëm)
- Klasa e sigurisë së pajisjes: II
- Kategoria e mbtensionit (EN 62109): klasa III
- Mbërthimi me vidë i përcjellësit, maks. 2,5 mm<sup>2</sup>
- Pajisja me distancë kontakti prej të paktën 3 mm
- Një çelës lehtësisht i aksesueshëm me stakim duhet të instalohet në pjesën e sipërme nga zilha
- në përputhje me direktivat EMC dhe LVD



*Bell 230V~ 6mA rms 1M*

- power supply 230 V~ 50/60 Hz
- power consumption when playing melody 1: 4.7 mA rms
- power consumption when playing melody 2: 5.9 mA rms
- sound level of melody 1: 90.5 dB
- sound level of melody 2: 86 dB
- operating temperature 0°C/45°C (indoor use)
- storage temperature: -20°C /50°C
- IP protection class: IP20 (indoor use only)
- class device II
- overvoltage category (EN62109): Class III
- screw contacts: max. 2.5 mm<sup>2</sup>
- device with a contact gap of at least 3 mm
- an easily accessible cut-off switch must be installed upstream from bell
- complies with EMC & LVD directives

EM91  
EM93  
EM94

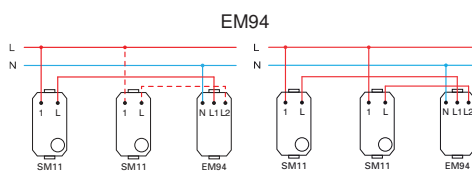
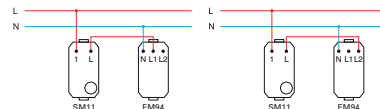
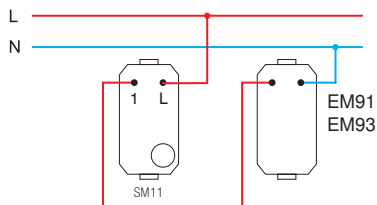
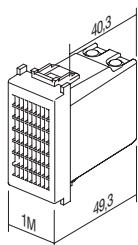

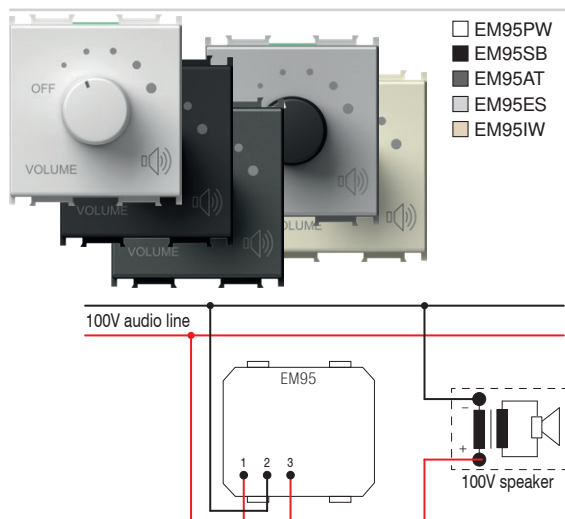

### KONTROLL VOLUMI 100 V LINJË AUDIO 35 W 2M

- kontroll volumi (atenuator) për sisteme audio 100 V
- vlerësimi i fuqisë 35 W (maks. 45 W), 6 hapa kontrolli volumi
- i përshtatshëm për kuti (min. 60 mm thellësi)
- i papërshtatshëm për instalim në kuti me thellësi 45 mm dhe kuti montimi në sipërfaqe CUBO IP20
- vetëm për përdorim të brendshëm

#### VOLUME CONTROL 100V AUDIO LINE 35W 2M

- volume control (attenuator) for 100V audio systems
- power rating 35W (max.45W), 6 steps volume control
- suitable for boxes min. 60 mm deep
- not suitable for installation in 45 mm deep boxes and surface mount boxes CUBO IP20
- for indoor use only

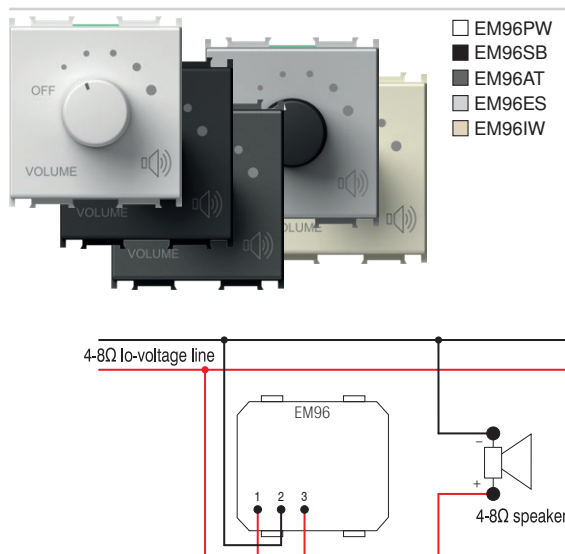

### KONTROLL VOLUMI 4-8 Ω 35 W 2M

- kontroll volumi (atenuator) për dalje të tensionit të ulët 4-8 Ω, 35 W
- mundësi lidhjeje me pajisjet HI-FI
- fuqi nominale 35 W, kontroll i volumit me 6 hapa
- i përshtatshëm për kuti (min. 60 mm thellësi)
- i papërshtatshëm për instalim në kuti me thellësi 45 mm dhe kuti montimi në sipërfaqe CUBO IP20
- vetëm për përdorim të brendshëm

#### VOLUME CONTROL 4-8 Ω 35W 2M

- volume control (attenuator) for low voltage outputs 4-8 Ω, 35W
- power rating 35W, 6 steps volume control
- suitable for boxes min. 60 mm deep
- not suitable for installation in 45 mm deep boxes and surface mount boxes CUBO IP20
- for indoor use only

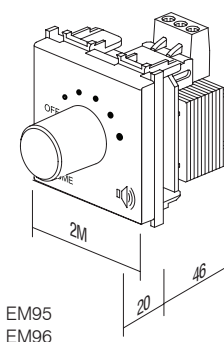

EM95  
EM96



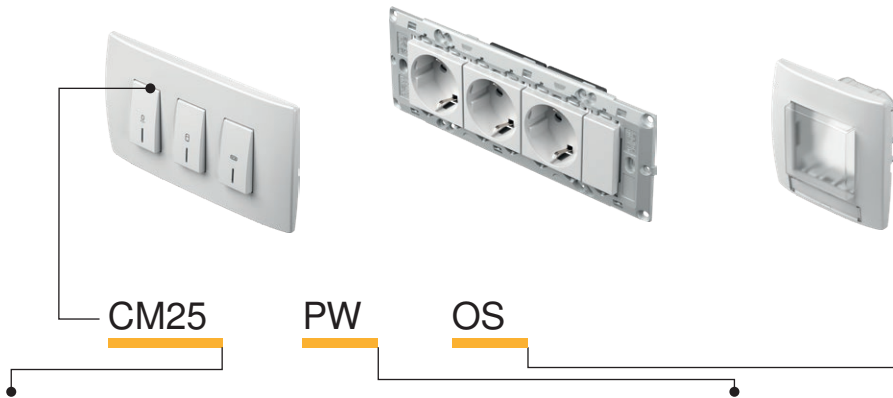

Iloji type	përshkrimi description	të dhënat teknike technical data	madhësia size	ngjyra colour	të dhënat opsionale 1 optional data 1
CM10	SET PRIZJE 2x SCHUKO SOCKET SET 2x SCHUKO	2P+E 16A 250V~	4M	<input type="checkbox"/> PW e bardhë polare polar white	<input type="checkbox"/> OL kapak mbulues LINE cover plate LINE
CM11	SET PRIZJE 3x SCHUKO SOCKET SET 3x SCHUKO	2P+E 16A 250V~	7M	<input checked="" type="checkbox"/> SB e zezë soft touch soft touch black	<input type="checkbox"/> OS kapak mbulues SOFT cover plate SOFT
CM15	SET LIDHJEJE LINK WIRE SET	3x1.5mm <sup>2</sup>	1M	<input checked="" type="checkbox"/> AT antracit anthracite	
·	·	·	·	<input type="checkbox"/> ES e argjendtë elox elox silver	
·	·	·	·	<input type="checkbox"/> IW e bardhë fildishi ivory white	

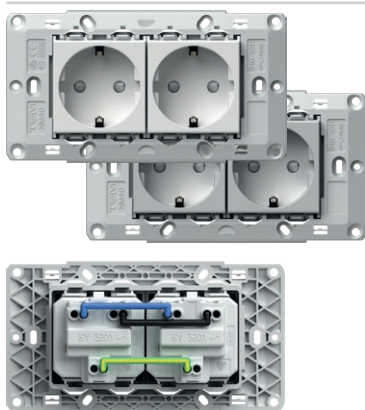

- CM10PW
- CM10ES

#### SET PRIZASH 2x SCHUKO 2P+E 16 A 250 V~ 4M

- set prizash 2x schuko VM10 2P+E 16 A 250 V~
- pajisur paraprakisht me lidhje telash CM16
- me kornizë montimi 4M pa vida
- për montimin e kornizës përdorni vida CM17, CM18 ose CM19
- kontaktet e vidave 1,5-2,5 mm<sup>2</sup>
- në përputhje me IEC 60884-1, CEE7

#### SOCKETS SET 2x SCHUKO 2P+E 16A 250V~ 4M

- socket set 2x schuko VM10 2P+E 16A 250V~
- prewired with link wires CM16
- with mounting frame 4M without screws
- for mounting frame fixing use screws CM17, CM18 or CM19
- screw contacts 1.5-2.5 mm<sup>2</sup>
- in accordance with IEC-60884-1, CEE7

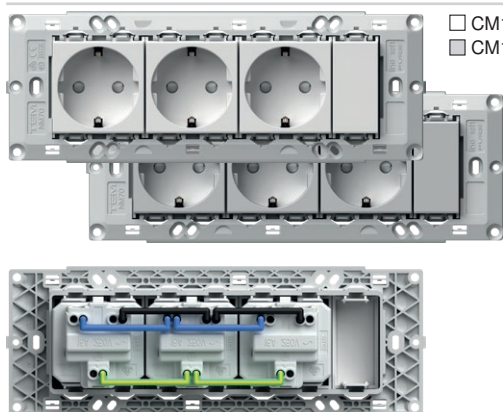
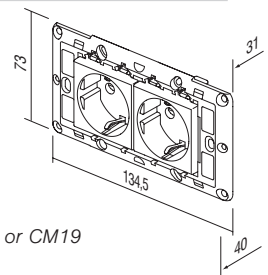

- CM11PW
- CM11ES

#### SET PRIZASH 3x SCHUKO 2P+E 16 A 250 V~ 7M

- set prizash 3x schuko VM10 2P+E 16 A 250 V~
- pajisur paraprakisht me lidhje telash CM16
- me kornizë montimi 7M pa vida
- për montimin e kornizës përdorni vida CM17, CM18 ose CM19
- kontaktet e vidave 1,5-2,5 mm<sup>2</sup>
- në përputhje me IEC 60884-1, CEE7

#### SOCKETS SET 3x SCHUKO 2P+E 16A 250V~ 7M

- socket set 3x schuko VM10 2P+E 16A 250V~
- prewired with link wires CM16
- with mounting frame 7M without screws
- for mounting frame fixing use screws CM17, CM18 or CM19
- screw contacts 1.5-2.5 mm<sup>2</sup>
- in accordance with IEC-60884-1, CEE7

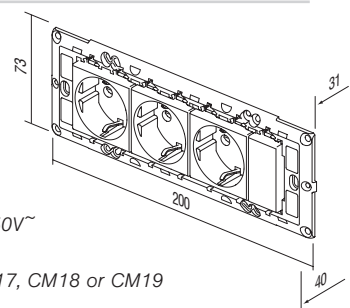

**SET LIDHJEJE 3x1,5 mm<sup>2</sup> 1M**

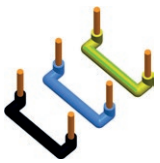

CM15

- set lidhjeje për të lidhur dy elemente madhësia 1M
- përfshin 10 tela të zi, 10 blu dhe 10 të verdhë/të gjelbër

**LINK WIRE SET 3x1.5mm<sup>2</sup> 1M**

- link wire set to connect two elements size 1M
- includes 10 black, 10 blue and 10 yellow/green wires

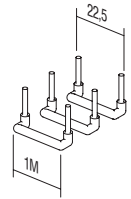

**SET LIDHJEJE 3x2,5 mm<sup>2</sup> 2M**

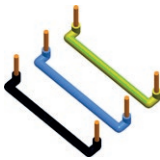

CM16

- set lidhjeje për të lidhur dy elemente madhësia 2M
- përfshin 10 tela të zi, 10 blu dhe 10 të verdhë/të gjelbër

**LINK WIRE SET 3x2.5mm<sup>2</sup> 2M**

- link wire set to connect two elements size 2M
- includes 10 black, 10 blue and 10 yellow/green wires

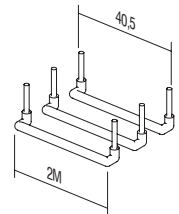

**SET VIDASH 3,5**

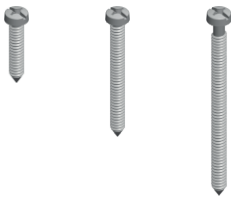

CM17  
CM18  
CM19

- set vidash për fiksimin e kornizave të montimit NM30, NM32, NM40, NM41, NM70
- CM17 - l=20mm, 100 copë
- CM18 - l=35mm, 50 copë
- CM19 - l=50mm, 50 copë

**SCREW SET 3,5**

- screw set for fixing mounting frames NM30, NM32, NM40, NM41, NM70
- CM17 - l=20mm, 100pcs
- CM18 - l=35mm, 50pcs
- CM19 - l=50mm, 50pcs

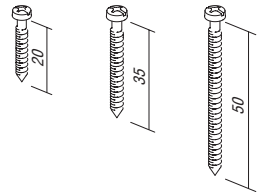

**SET ÇELËSASH IP44 2M**



- CM22PW
- CM22SB
- CM22AT
- CM22ES
- CM22IW

- për përdorim në zona me lagështirë
- të gjithë çelësat Modul janë të pajisur me mbrojtje IP44
- çelësat dhe butonat nuk janë pjesë e setit
- kapak mbulues SOFT 2M me pllakë me mbishkrim
- në përputhje me IEC 60669-1

**SET SWITCHES IP44 2M**

- for usage in humid areas
- IP44 protection provides for all Modul switches
- switches and buttons are not part of the set
- SOFT 2M cover plate with inscription plate
- in accordance with IEC 60669-1



**SET PRIZASH IP44 2M**



- CM23PW
- CM23SB
- CM23AT
- CM23ES
- CM23IW

- për përdorim në zona me lagështirë
- mbrojtja IP44 mund të arrihet vetëm në kombinim me prizën e mbuluar (VM11, VM41)
- prizat nuk janë pjesë e setit
- kapak mbulues SOFT 2M me pllakë me mbishkrim
- në përputhje me IEC 60884-1

**SET SOCKETS IP44 2M**

- for usage in humid areas
- IP44 protection can be achieved only in combination with covered socket (VM11, VM41)
- sockets are not part of the set
- SOFT 2M cover plate with inscription plate
- in accordance with IEC 60884-1



**SET ÇELËSASH PËR BANJË 3x20 A 250 V~ 4M**

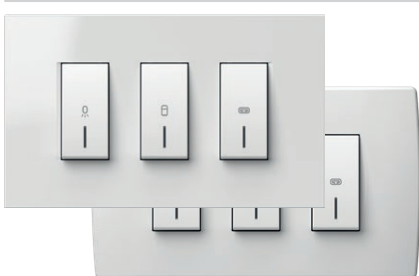

- CM25PWOL
- CM25IWOL
- CM25PWOS
- CM25IWOS

- set çelësash 3xSM12 20 A 250 V~ me kornizë montimi dhe kapak mbulues
- kontaktet e vidave 1,5-2,5mm<sup>2</sup>
- në përputhje me EN 60669-1
- zgjidhje universale për rinovimin e kutive me dimensione fikse 108-135 mm ose kuti madhësia 4M
- kapak mbulues lartësia 90 mm

**SWITCH SET FOR BATHROOM 3x20A 250V~ 4M**

- switch set 3xSM12 20A 250V~ with mounting frame and cover plate
- screw contacts 1.5-2.5mm<sup>2</sup>
- in accordance with EN 60669-1
- universal solution for renovation on boxes with fixing dimensions 108-135mm or boxes 4M size
- cover plate height 90mm

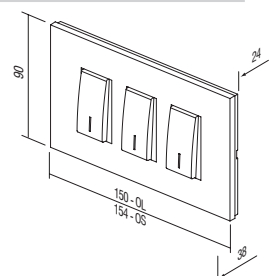

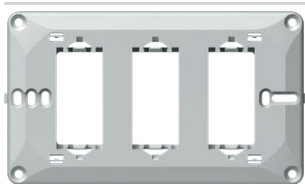

NM41

**SET KORNIZË MONTIMI PËR BANJË 4M**

- kornizë montimi universale për set banje me vida
- zgjidhje universale për montimin në kutitë drejtkëndore me dimensione fikse 108-135 mm ose kuti madhësia 4M
- në përputhje me EN 60669-1

**MOUNTING FRAME BATHROOM SET 4M**

- universal mounting frame for bathroom set with screws
- universal solution for mounting on rectangular boxes with fixing dimensions 108-135mm or boxes 4M size
- in accordance with EN 60669-1

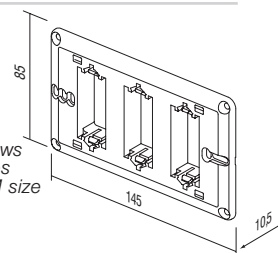

- |  |        |
|--|--------|
|  | OL41PW |
|  | OL41NB |
|  | OL41IW |
|  | OL41ES |
|  | OL41SG |
|  | OL41IB |
|  | OL41AT |
|  | OL41TI |
|  | OL41SB |

**SETI KAPAKU MBULUES LINE PËR BANJË**

- set dekorativ kapaku mbulues për banjë LINE
- lartësia 90 mm
- në përputhje me EN 60669-1

**COVER PLATE LINE BATHROOM SET**

- decorative cover plate bathroom set LINE
- height 90mm
- in accordance with EN 60669-1

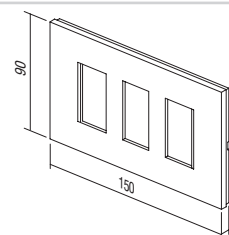

- |  |        |  |        |
|--|--------|--|--------|
|  | OS41PW |  | OS41SB |
|  | OS41NB |  | OS41WE |
|  | OS41IW |  | OS41AT |
|  | OS41ES |  | OS41TI |
|  | OS41SG |  |        |

**SETI KAPAKU MBULUES SOFT PËR BANJË**

- set dekorativ kapaku mbulues për banjë SOFT
- lartësia 90 mm
- në përputhje me EN 60669-1

**COVER PLATE SOFT BATHROOM SET**

- decorative cover plate bathroom set SOFT
- height 90mm
- in accordance with EN 60669-1

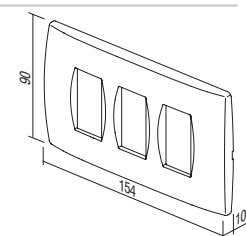

# PROGRAMI ANTIBAKTERIAL MODUL

Iloji type	përshkrimi description	madhësia size	ngjyra colour	të dhënat opsionale 1 optional data 1
TM11	BUTON BUTTON	1M	<input type="checkbox"/> AW e bardhë antibakteriale antibacterial white	NT neutral neutral
TM21	FALSO BLANK	1M		
VM10	PRIZË SOCKET	2M		IN treguesi indicator
.	.	.		
.	.	.		

## PROGRAMI ANTIBAKTERIAL MODUL

- çelësat dhe prizat preken çdo ditë nga shumë njerëz, prandaj janë një vend i zakonshëm për zhvillimin dhe përhapjen e baktereve
- falë karakteristikave të veta natyrale, argjendi është përdorur për tremijë vjet si dezinfektues i sigurt dhe efikas, duke qenë se është plotësisht natyral, i shëndetshëm dhe miqësor për mjedisin
- jonet speciale antibakteriale të argjendit ofrojnë mbrojtje afatgjatë, të qëndrueshme dhe efektive kundër zhvillimit dhe përhapjes së baktereve, mikrobeve dhe kërpudhave
- mbrojtja antibakteriale siguron higjienë, pastërti dhe shëndet për njerëzit
- programi antibakterial MODUL është plotësisht i përshtatshëm për përdorim në mjedise me kushte të rrepta higjienike (spitale, qendra shëndetësore, ambiente farmaceutike, azile pleqsh, laboratorë, restorante, hotele, aeroporte, stacione hekurudhore dhe autobusi, qendra biznesi dhe tregtare, institucione publike...)
- janë kryer testime të pavarura laboratorike në përputhje me standardet më të larta japoneze JIS Z 2801
- kosto e ulët për të siguruar shëndetin e njeriut
- dizajni dhe funksionimi i programit antibakterial MODUL lejon pastrim dhe mirëmbajtje të lehtë
- butonat antibakteriale, kapakët mbulues dhe prizat kombinohen me versione klasike të kornizave dhe çelësave
- produktet etiketohen në pjesën e pasme me AW (e bardhë antibakteriale)

## ANTIBACTERIAL PROGRAM MODUL

- switches and sockets are daily touched by many people, so this is a common place for development and spread of bacteria
- thanks to its natural antibacterial characteristics silver has been used for three millennia as a safe and effective disinfectant, since it is completely natural, healthy and environmentally friendly
- special antibacterial silver ions additive provides long-term, reliable and effective protection against the development and spread of bacteria, microbes and fungi
- antibacterial protection ensures hygiene, cleanliness and health for people
- perfectly suitable for use in environments with strict hygiene conditions (hospitals, health centers, pharmaceutical facilities, homes for elderly, nursing homes, laboratories, restaurants, hotels, airports, bus and railway stations, business and shopping areas, public institutions ...)
- independent laboratory testings have been carried out in accordance with highest Japanese standards JIS Z 2801
- low cost for providing human health
- design and functionality of antibacterial program MODUL allow easy cleaning and maintenance
- antibacterial buttons, cover plates and sockets are combined with classic mounting frames and switches
- products are labelled on the back with AW (antibacterial white)

## A N T I B A C T E R I A L P R O G R A M M O D U L

	□ TM11AW	<p><b>BUTON 1M</b></p> <ul style="list-style-type: none"> <li>- buton i ndërrueshëm 1M</li> <li>- në përputhje me EN 60669-1</li> <li>- mbrojtje antibakteriale në përputhje me standardin JIS Z 2801</li> </ul> <p><i>BUTTON 1M</i></p> <ul style="list-style-type: none"> <li>- replaceable button 1M</li> <li>- in accordance with EN 60669-1</li> <li>- antibacterial protection in accordance with JIS Z 2801</li> </ul>	
	□ TM11AWIN	<p><b>TREGUES BUTONI 1M</b></p> <ul style="list-style-type: none"> <li>- buton i ndërrueshëm 1M</li> <li>- në përputhje me EN 60669-1</li> <li>- mbrojtje antibakteriale në përputhje me standardin JIS Z 2801</li> </ul> <p><i>BUTTON 1M INDICATOR</i></p> <ul style="list-style-type: none"> <li>- replaceable button 1M</li> <li>- in accordance with EN 60669-1</li> <li>- antibacterial protection in accordance with JIS Z 2801</li> </ul>	
	□ TM12AW	<p><b>BUTON 2M</b></p> <ul style="list-style-type: none"> <li>- buton i ndërrueshëm 2M me mbajtëse butoni</li> <li>- për të përditësuar çelësin ose butonin me shtypje nga madhësia 1M në madhësinë 2M</li> <li>- në përputhje me EN 60669-1</li> <li>- mbrojtje antibakteriale në përputhje me standardin JIS Z 2801</li> </ul> <p><i>BUTTON 2M</i></p> <ul style="list-style-type: none"> <li>- replaceable button 2M with button carrier</li> <li>- to upgrade switch or push button from size 1M to size 2M</li> <li>- in accordance with EN 60669-1</li> <li>- antibacterial protection in accordance with JIS Z 2801</li> </ul>	
	□ TM12AWIN	<p><b>TREGUES BUTONI 2M</b></p> <ul style="list-style-type: none"> <li>- buton i ndërrueshëm 2M me mbajtëse butoni</li> <li>- për të përditësuar çelësin ose butonin me shtypje nga madhësia 1M në madhësinë 2M</li> <li>- në përputhje me EN 60669-1</li> <li>- mbrojtje antibakteriale në përputhje me standardin JIS Z 2801</li> </ul> <p><i>BUTTON 2M INDICATOR</i></p> <ul style="list-style-type: none"> <li>- replaceable button 2M with button carrier</li> <li>- to upgrade switch or push button from size 1M to size 2M</li> <li>- in accordance with EN 60669-1</li> <li>- antibacterial protection in accordance with JIS Z 2801</li> </ul>	
	□ TM21AW	<p><b>FALSO 1M</b></p> <ul style="list-style-type: none"> <li>- modul falso për të mbushur hapësirat boshe</li> <li>- në përputhje me EN 60669-1</li> <li>- mbrojtje antibakteriale në përputhje me standardin JIS Z 2801</li> </ul> <p><i>BLANK 1M</i></p> <ul style="list-style-type: none"> <li>- blank modul to fill up empty spaces</li> <li>- in accordance with EN 60669-1</li> <li>- antibacterial protection in accordance with JIS Z 2801</li> </ul>	
	□ TM22AW	<p><b>FALSO 2M</b></p> <ul style="list-style-type: none"> <li>- modul falso për të mbushur hapësirat boshe</li> <li>- në përputhje me EN 60669-1</li> <li>- mbrojtje antibakteriale në përputhje me standardin JIS Z 2801</li> </ul> <p><i>BLANK 2M</i></p> <ul style="list-style-type: none"> <li>- blank modul to fill up empty spaces</li> <li>- in accordance with EN 60669-1</li> <li>- antibacterial protection in accordance with JIS Z 2801</li> </ul>	



□ VM10AW

PRIZË SCHUKO+KS 2P+E 16 A 250 V~ 2M

- 2P+E schuko
- 16 A 250 V~, lloji VM10
- në përputhje me IEC 60884-1, CEE7
- kontaktet e vidave 1,5-2,5 mm<sup>2</sup>
- kontaktet me rrymën të mbuluara
- mbrojtje antibakteriale në përputhje me standardin JIS Z 2801

SOCKET SCHUKO+KS 2P+E 16A 250V~ 2M

- 2P+E schuko
- 16A 250V~, type VM10
- in accordance with IEC 60884-1, CEE7
- screw contacts 1.5-2.5 mm<sup>2</sup>
- shuttered live contacts
- antibacterial protection in accordance with JIS Z 2801



□ VM11AW

PRIZË SCHUKO+KS+KAPAK 2P+E 16 A 250 V~ 2M

- 2P+E schuko+kapak
- 16 A 250 V~, lloji VM11
- në përputhje me IEC 60884-1, CEE7
- kontaktet e vidave 1,5-2,5 mm<sup>2</sup>
- kontaktet me rrymën të mbuluara
- mbrojtje antibakteriale në përputhje me standardin JIS Z 2801

SOCKET SCHUKO+KS+COVER

- 2P+E schuko+cover
- 16A 250V~, type VM11
- in accordance with IEC 60884-1, CEE7
- screw contacts 1.5-2.5 mm<sup>2</sup>
- shuttered live contacts
- antibacterial protection in accordance with JIS Z 2801



□ VM20AW

PRIZË EURO+KS 2P 10A 250 V~ 1M

- 2P Euro
- 10A 250 V~, lloji VM20
- në përputhje me IEC 60884-1, CEE7
- kontaktet e vidave 1,5-2,5 mm<sup>2</sup>
- kontaktet me rrymën të mbuluara
- mbrojtje antibakteriale në përputhje me standardin JIS Z 2801

SOCKET EURO+KS 2P 10A 250V~ 1M

- 2P Euro
- 10A 250V~, type VM20
- in accordance with IEC 60884-1, CEE7
- screw contacts 1.5-2.5 mm<sup>2</sup>
- shuttered live contacts
- antibacterial protection in accordance with JIS Z 2801



□ KM11AW

PRIZË TV ME KAPAK FUNDOR 1dB 1M

- TV me kapak fundor
- gama e frekuencës 5÷2400 MHz
- reduktimi < 1 dB
- në përputhje me EN 50083-1
- kontaktet e vidave
- mbrojtje antibakteriale në përputhje me standardin JIS Z 2801

SOCKET TV END-LINE 1dB 1M

- TV end-line
- frequency range 5÷2400 MHz
- reduction < 1 dB
- in accordance with EN 50083-1
- screw contacts
- antibacterial protection in accordance with JIS Z 2801

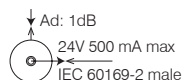

□ KM35AW

PËRSHTATËS KS 1M

- standard fiksues trapez KS
- AMP, Avaya, Brandrex, FMT, Mfico, Tyco, ...
- moduli i komunikimit nuk përfshihet
- mbrojtje antibakteriale në përputhje me standardin JIS Z 2801

ADAPTER KS 1M

- KS keystone fixing standard
- AMP, Avaya, Brandrex, FMT, Mfico, Tyco, ...
- communication module not included
- antibacterial protection in accordance with JIS Z 2801

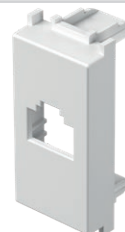



OS20AW

#### KAPAK MBULUES SOFT 2M

- kapak mbulues dekorativ SOFT 2M
- në përputhje me EN 60669-1
- mbrojtje antibakteriale në përputhje me standardin JIS Z 2801

#### COVER PLATE SOFT 2M

- decorative cover plate SOFT 2M
- in accordance with EN 60669-1
- antibacterial protection in accordance with JIS Z 2801



OS24AW

#### KAPAK MBULUES SOFT 2x2M

- kapak mbulues dekorativ SOFT 2x2M
- montim horizontal ose vertikal
- në përputhje me EN 60669-1
- mbrojtje antibakteriale në përputhje me standardin JIS Z 2801

#### COVER PLATE SOFT 2x2M

- decorative cover plate SOFT 2x2M
- horizontal or vertical mounting
- in accordance with EN 60669-1
- antibacterial protection in accordance with JIS Z 2801



OS26AW

#### KAPAK MBULUES SOFT 3x2M

- kapak mbulues dekorativ SOFT 3x2M
- montim horizontal ose vertikal
- në përputhje me EN 60669-1
- mbrojtje antibakteriale në përputhje me standardin JIS Z 2801

#### COVER PLATE SOFT 3x2M

- decorative cover plate SOFT 3x2M
- horizontal or vertical mounting
- in accordance with EN 60669-1
- antibacterial protection in accordance with JIS Z 2801



OS30AW

#### KAPAK MBULUES SOFT 3M

- kapak mbulues dekorativ SOFT 3M
- në përputhje me EN 60669-1
- mbrojtje antibakteriale në përputhje me standardin JIS Z 2801

#### COVER PLATE SOFT 3M

- decorative cover plate SOFT 3M
- in accordance with EN 60669-1
- antibacterial protection in accordance with JIS Z 2801



OS40AW

#### KAPAK MBULUES SOFT 4M

- kapak mbulues dekorativ SOFT 4M
- në përputhje me EN 60669-1
- mbrojtje antibakteriale në përputhje me standardin JIS Z 2801

#### COVER PLATE SOFT 4M

- decorative cover plate SOFT 4M
- in accordance with EN 60669-1
- antibacterial protection in accordance with JIS Z 2801

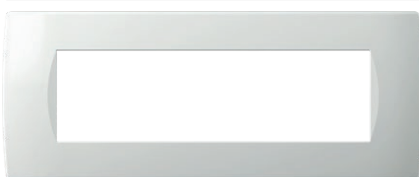

OS70AW

#### KAPAK MBULUES SOFT 7M

- kapak mbulues dekorativ SOFT 7M
- në përputhje me EN 60669-1
- mbrojtje antibakteriale në përputhje me standardin JIS Z 2801

#### COVER PLATE SOFT 7M

- decorative cover plate SOFT 7M
- in accordance with EN 60669-1
- antibacterial protection in accordance with JIS Z 2801

dru  
wood

WB bambu  
bamboo



WW arrë  
walnut



WM panjë  
maple



WE venge  
wenge



**Natyra është unike dhe e çmuar, sepse kapakët tanë mbulues dekorativë nuk janë dy njësoj.**  
*Nuk mund të konsiderohen ankesat rreth pamjes diverse dhe ndryshimeve të kapakëve dekorativë prej druri.*

**Nature is unique and precious, as our decorative cover plates where no two are the same.**  
*Complaints about wooden decorative cover plate's diverse appearance and differentiation cannot be considered.*

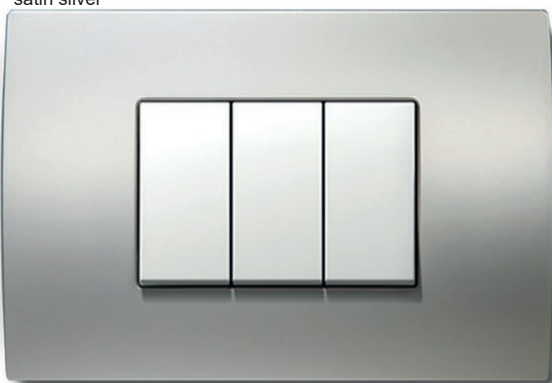
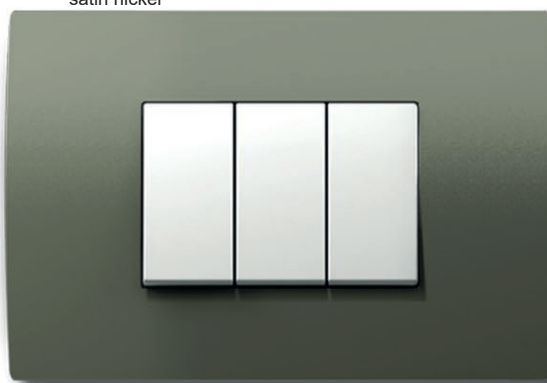
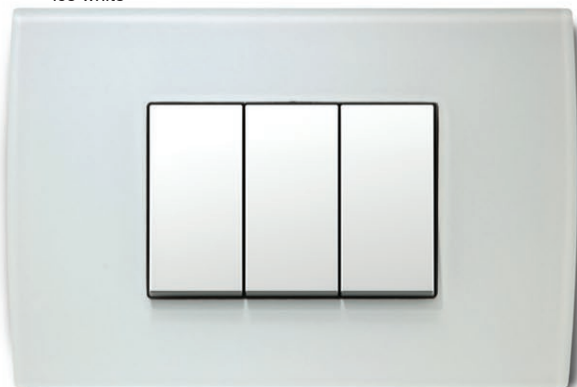
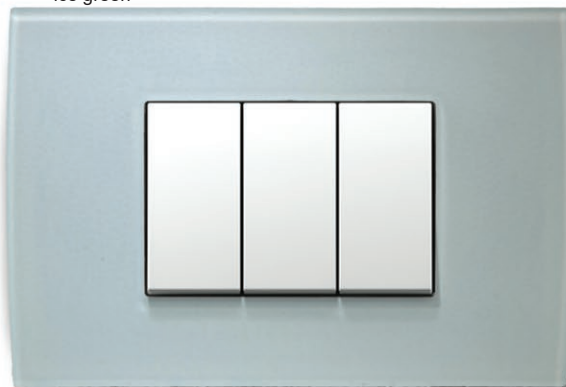
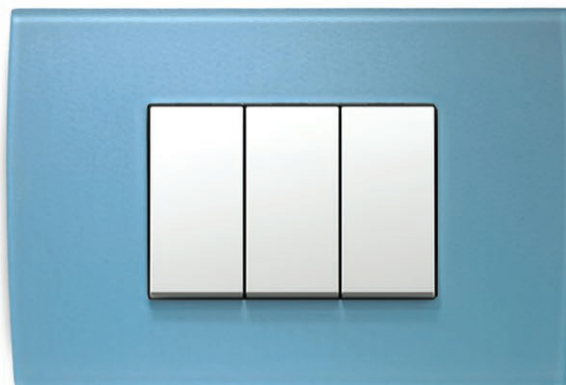

## C O V E R P L A T E S P U R E O P

metal  
metalMH çelik i rrahur  
hammered steelME hekur i ngrënë  
etched ironMS argjend satin  
satin silverMN nikel satin  
satin nickelxham  
glassGW e bardhë akulli  
ice whiteGG e gjelbër akulli  
ice greenGY gri akulli  
ice greyGB blu akulli  
ice blue

# KAPAKËT MBULUES PURE OP



OP30

WB

lloji type	përshkrimi description	madhësia size	ngjyra colour	
OP13	KAPAK MBULUES PURE COVER PLATE PURE	1/3M	MH çeliki i rrahur hammered steel	WB bambo bamboo
OP20	KAPAK MBULUES PURE COVER PLATE PURE	2M	ME hekur i ngrënë etched iron	WW arrë walnut
OP23	KAPAK MBULUES PURE COVER PLATE PURE	2/3M	MS argjend satin satin silver	WM panjë maple
.	.	.	MN nikel satin satin nickel	WE venge wenge
.	.	.		GW e bardhë akulli ice white
.	.	.		GG e gjelbër akulli ice green
.	.	.		GY gri akulli ice grey
.	.	.		GB blu akulli ice blue



OP20MH	OP20WB
OP20ME	OP20WW
OP20MS	OP20WM
OP20MN	OP20WE
	OP20GW
	OP20GG
	OP20GY
	OP20GB

## KAPAK MBULUES PURE 2M

- kapak mbulues dekorativ PURE 2M
- në përputhje me EN 60669-1
- vetëm në kombinim me kornizë montimi NM24 ose NM25

### COVER PLATE PURE 2M

- decorative cover plate PURE 2M
- in accordance with EN 60669-1
- only in combination with mounting frame NM24 or NM25



OP24MH	OP24WB
OP24ME	OP24WW
OP24MS	OP24WM
OP24MN	OP24WE
	OP24GW
	OP24GG
	OP24GY
	OP24GB

## KAPAK MBULUES PURE 2x2M

- kapak mbulues dekorativ PURE 2x2M
- montim horizontal ose vertikal
- në përputhje me EN 60669-1
- vetëm në kombinim me kornizë montimi NM24 ose NM25

### COVER PLATE PURE 2x2M

- decorative cover plate PURE 2x2M
- horizontal or vertical mounting
- in accordance with EN 60669-1
- only in combination with mounting frames NM24 or NM25



OP26MH	OP26WB
OP26ME	OP26WW
OP26MS	OP26WM
OP26MN	OP26WE
	OP26GW
	OP26GG
	OP26GY
	OP26GB

## KAPAK MBULUES PURE 3x2M

- kapak mbulues dekorativ PURE 3x2M
- montim horizontal ose vertikal
- në përputhje me EN 60669-1
- vetëm në kombinim me kornizë montimi NM24 ose NM25

### COVER PLATE PURE 3x2M

- decorative cover plate PURE 3x2M
- horizontal or vertical mounting
- in accordance with EN 60669-1
- only in combination with mounting frames NM24 or NM25



OP28MH	OP28WB
OP28ME	OP28WW
OP28MS	OP28WM
OP28MN	OP28WE
	OP28GW
	OP28GG
	OP28GY
	OP28GB

## KAPAK MBULUES PURE 4x2M

- kapak mbulues dekorativ PURE 4x2M
- montim horizontal ose vertikal
- në përputhje me EN 60669-1
- vetëm në kombinim me kornizë montimi NM24 ose NM25

### COVER PLATE PURE 4x2M

- decorative cover plate PURE 4x2M
- horizontal or vertical mounting
- in accordance with EN 60669-1
- only in combination with mounting frames NM24 or NM25

MODUL

PURE

C O V E R P L A T E S P U R E O P



	OP30MH		OP30WB
	OP30ME		OP30WW
	OP30MS		OP30WM
	OP30MN		OP30WE
			OP30GW
			OP30GG
			OP30GY
			OP30GB

KAPAK MBULUES PURE 3M

- kapak mbulues dekorativ PURE 3M  
- në përputhje me EN 60669-1

COVER PLATE PURE 3M

- decorative cover plate PURE 3M  
- in accordance with EN 60669-1



	OP40MH		OP40WB
	OP40ME		OP40WW
	OP40MS		OP40WM
	OP40MN		OP40WE
			OP40GW
			OP40GG
			OP40GY
			OP40GB

KAPAK MBULUES PURE 4M

- kapak mbulues dekorativ PURE 4M  
- në përputhje me EN 60669-1

COVER PLATE PURE 4M

- decorative cover plate PURE 4M  
- in accordance with EN 60669-1



	OP70MH		OP70WB
	OP70ME		OP70WW
	OP70MS		OP70WM
	OP70MN		OP70WE
			OP70GW
			OP70GG
			OP70GY
			OP70GB

KAPAK MBULUES PURE 7M

- kapak mbulues dekorativ PURE 7M  
- në përputhje me EN 60669-1

COVER PLATE PURE 7M

- decorative cover plate PURE 7M  
- in accordance with EN 60669-1



	OP13MH		OP13WB
	OP13ME		OP13WW
	OP13MS		OP13WM
	OP13MN		OP13WE
			OP13GW
			OP13GG
			OP13GY
			OP13GB

KAPAK MBULUES PURE 1/3M

- kapak mbulues dekorativ PURE 1/3M  
- në përputhje me EN 60669-1

COVER PLATE PURE 1/3M

- decorative cover plate PURE 1/3M  
- in accordance with EN 60669-1



	OP23MH		OP23WB
	OP23ME		OP23WW
	OP23MS		OP23WM
	OP23MN		OP23WE
			OP23GW
			OP23GG
			OP23GY
			OP23GB

KAPAK MBULUES PURE 2/3M

- kapak mbulues dekorativ PURE 2/3M  
- në përputhje me EN 60669-1

COVER PLATE PURE 2/3M

- decorative cover plate PURE 2/3M  
- in accordance with EN 60669-1

bazë  
basic

PW e bardhë polare  
polar white

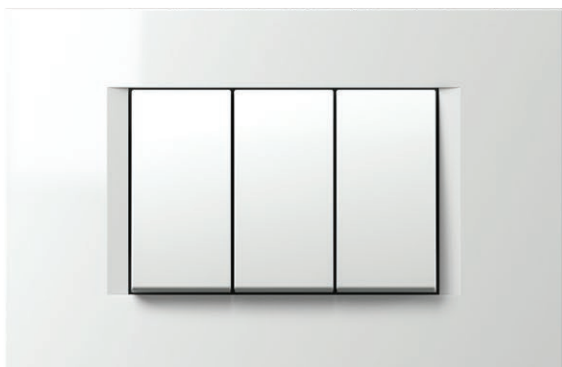

IW e bardhë fildishi  
ivory white

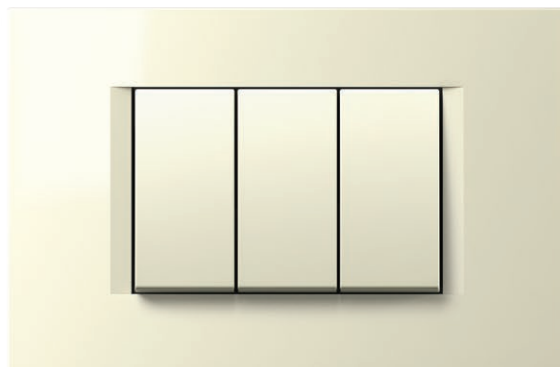

ES e argjendtë elox  
elox silver



SB e zezë soft touch  
soft touch black



AT antracit  
anthracite

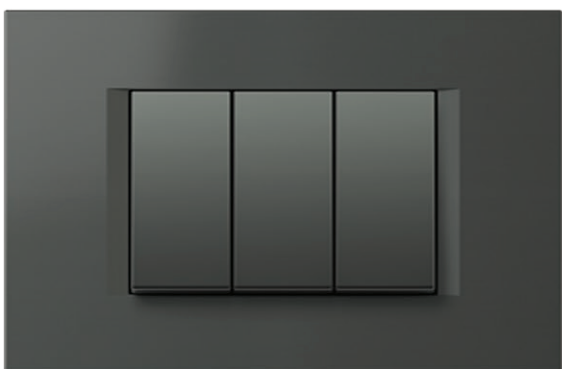

## COVER PLATES LINE OL

dekor  
decor

SG e artë ranore  
sand gold

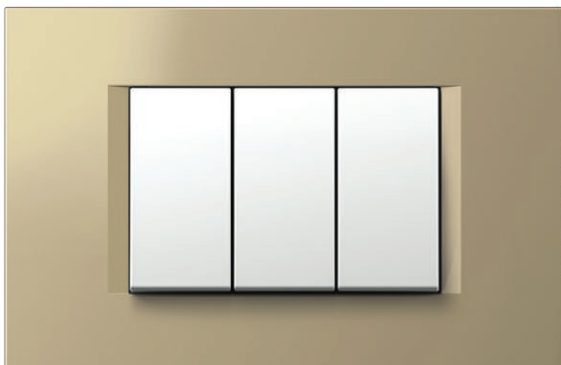

NB e zezë mesnate  
night black

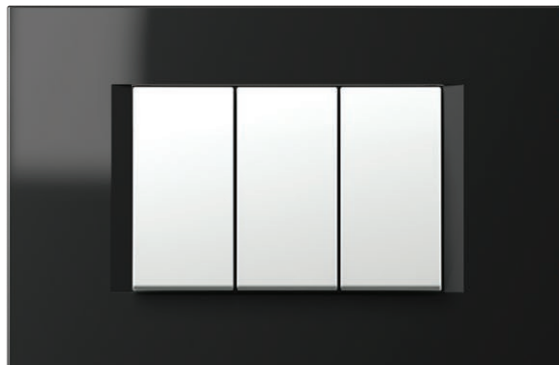

IB Impuls blu  
impulse blue



TI titan  
titanium



SW e bardhë guri  
stone white



# KAPAK ËT MBULUES LINE OL

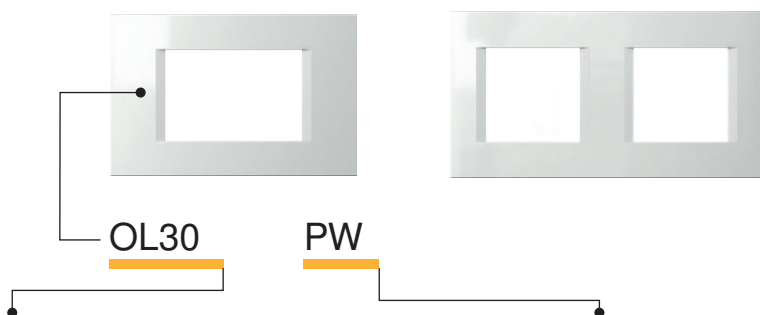

lloji type	përshkrimi description	madhësia size	ngjyra colour												
OL10	KAPAK MBULUES LINE COVER PLATE LINE	1/2M	<table border="0"> <tr> <td></td> <td>PW e bardhë polare polar white</td> <td></td> <td>SG e artë ranore sand gold</td> <td></td> <td>AT antracit anthracite</td> </tr> </table>		PW e bardhë polare polar white		SG e artë ranore sand gold		AT antracit anthracite						
	PW e bardhë polare polar white		SG e artë ranore sand gold		AT antracit anthracite										
OL13	KAPAK MBULUES LINE COVER PLATE LINE	1/3M	<table border="0"> <tr> <td></td> <td>IW e bardhë fildishi ivory white</td> <td></td> <td>NB e zezë mesnate night black</td> <td></td> <td>TI titan titanium</td> </tr> </table>		IW e bardhë fildishi ivory white		NB e zezë mesnate night black		TI titan titanium						
	IW e bardhë fildishi ivory white		NB e zezë mesnate night black		TI titan titanium										
OL20	KAPAK MBULUES LINE COVER PLATE LINE	2M	<table border="0"> <tr> <td></td> <td>ES e argjendtë elox elox silver</td> <td></td> <td>IB Impuls blu impulse blue</td> <td></td> <td>SW e bardhë guri stone white</td> </tr> <tr> <td></td> <td>SB e zezë soft touch soft touch black</td> <td></td> <td></td> <td></td> <td></td> </tr> </table>		ES e argjendtë elox elox silver		IB Impuls blu impulse blue		SW e bardhë guri stone white		SB e zezë soft touch soft touch black				
	ES e argjendtë elox elox silver		IB Impuls blu impulse blue		SW e bardhë guri stone white										
	SB e zezë soft touch soft touch black														



## KAPAK MBULUES LINE 2M



	OL20PW		OL20SG
	OL20IW		OL20NB
	OL20ES		OL20IB
	OL20SB		OL20AT
			OL20TI
			OL20SW

- kapak mbulues dekorativ LINE 2M  
- në përputhje me EN 60669-1

### COVER PLATE LINE 2M

- decorative cover plate LINE 2M  
- in accordance with EN 60669-1

## KAPAK MBULUES LINE 2x2M

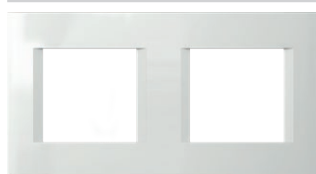

	OL24PW		OL24SG
	OL24IW		OL24NB
	OL24ES		OL24IB
	OL24SB		OL24AT
			OL24TI
			OL24SW

- kapak mbulues dekorativ LINE 2x2M  
- montim horizontal ose vertikal  
- në përputhje me EN 60669-1

### COVER PLATE LINE 2x2M

- decorative cover plate LINE 2x2M  
- horizontal or vertical mounting  
- in accordance with EN 60669-1

## KAPAK MBULUES LINE 3x2M

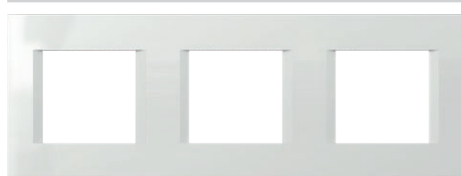

	OL26PW		OL26SG
	OL26IW		OL26NB
	OL26ES		OL26IB
	OL26SB		OL26AT
			OL26TI
			OL26SW

- kapak mbulues dekorativ LINE 3x2M  
- montim horizontal ose vertikal  
- në përputhje me EN 60669-1

### COVER PLATE LINE 3x2M

- decorative cover plate LINE 3x2M  
- horizontal or vertical mounting  
- in accordance with EN 60669-1

## KAPAK MBULUES LINE 4x2M



	OL28PW		OL28SG
	OL28IW		OL28NB
	OL28ES		OL28IB
	OL28SB		OL28AT
			OL28TI
			OL28SW

- kapak mbulues dekorativ LINE 4x2M  
- montim horizontal ose vertikal  
- në përputhje me EN 60669-1

### COVER PLATE LINE 4x2M

- decorative cover plate LINE 4x2M  
- horizontal or vertical mounting  
- in accordance with EN 60669-1

## KAPAK MBULUES LINE 5x2M

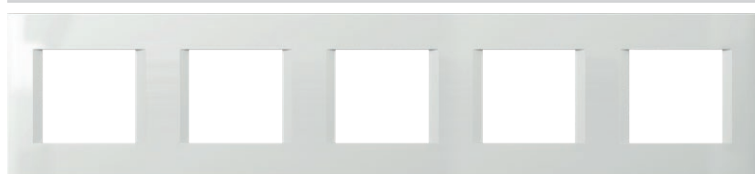

	OL29PW
	OL29IW
	OL29ES
	OL29SB
	OL29AT
	OL29TI

- kapak mbulues dekorativ LINE 5x2M  
- montim horizontal ose vertikal  
- në përputhje me EN 60669-1

### COVER PLATE LINE 5x2M





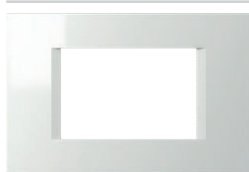

- decorative cover plate LINE 5x2M  
- horizontal or vertical mounting  
- in accordance with EN 60669-1

MODUL

LINE

## COVER PLATES LINE OL



 OL30PW	 OL30SG
 OL30IW	 OL30NB
 OL30ES	 OL30IB
 OL30SB	 OL30AT
	 OL30TI
	 OL30SW









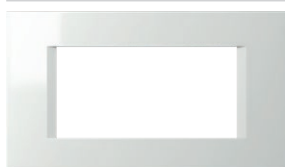

## KAPAK MBULUES LINE 3M

- kapak mbulues dekorativ LINE 3M  
- në përputhje me EN 60669-1

## COVER PLATE LINE 3M

- decorative cover plate LINE 3M  
- in accordance with EN 60669-1



 OL40PW	 OL40SG
 OL40IW	 OL40NB
 OL40ES	 OL40IB
 OL40SB	 OL40AT
	 OL40TI
	 OL40SW









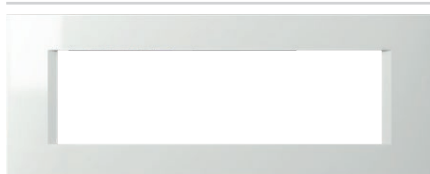

## KAPAK MBULUES LINE 4M

- kapak mbulues dekorativ LINE 4M  
- në përputhje me EN 60669-1

## COVER PLATE LINE 4M

- decorative cover plate LINE 4M  
- in accordance with EN 60669-1



 OL70PW	 OL70SG
 OL70IW	 OL70NB
 OL70ES	 OL70IB
 OL70SB	 OL70AT
	 OL70TI
	 OL70SW











## KAPAK MBULUES LINE 7M

- kapak mbulues dekorativ LINE 7M  
- në përputhje me EN 60669-1

## COVER PLATE LINE 7M

- decorative cover plate LINE 7M  
- in accordance with EN 60669-1



 OL10PW	 OL10SG
 OL10IW	 OL10NB
 OL10ES	 OL10IB
 OL10SB	 OL10AT
	 OL10TI
	 OL10SW









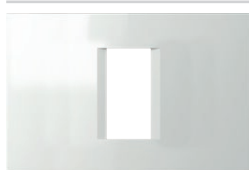

## KAPAK MBULUES LINE 1/2M

- kapak mbulues dekorativ LINE 1/2M  
- në përputhje me EN 60669-1

## COVER PLATE LINE 1/2M

- decorative cover plate LINE 1/2M  
- in accordance with EN 60669-1



 OL13PW	 OL13SG
 OL13IW	 OL13NB
 OL13ES	 OL13IB
 OL13SB	 OL13AT
	 OL13TI
	 OL13SW











## KAPAK MBULUES LINE 1/3M

- kapak mbulues dekorativ LINE 1/3M  
- në përputhje me EN 60669-1

## COVER PLATE LINE 1/3M

- decorative cover plate LINE 1/3M  
- in accordance with EN 60669-1



 OL23PW	 OL23SG
 OL23IW	 OL23NB
 OL23ES	 OL23IB
 OL23SB	 OL23AT
	 OL23TI
	 OL23SW

## KAPAK MBULUES LINE 2/3M

- kapak mbulues dekorativ LINE 2/3M  
- në përputhje me EN 60669-1

## COVER PLATE LINE 2/3M

- decorative cover plate LINE 2/3M  
- in accordance with EN 60669-1

bazë  
basic

PW e bardhë polare  
polar white

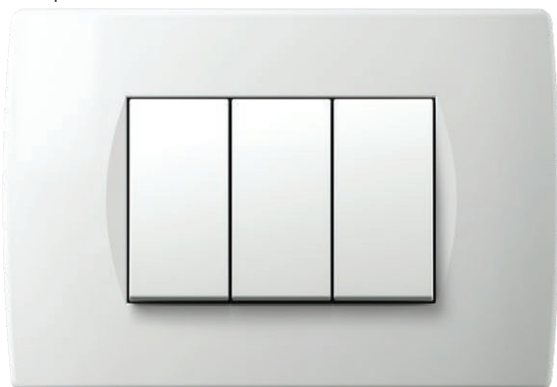

IW e bardhë fildishi  
ivory white

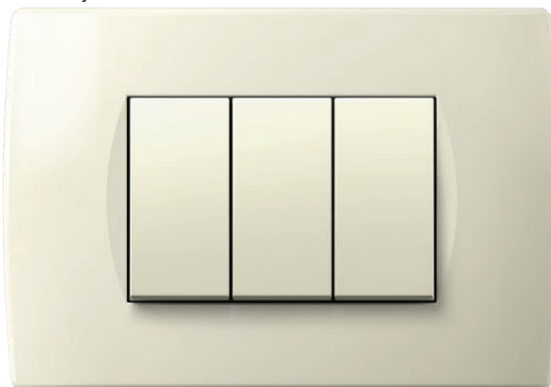

ES e argjendtë elox  
elox silver

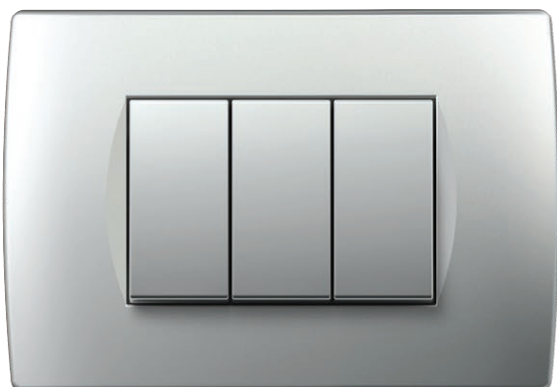

SB e zezë soft touch  
soft touch black

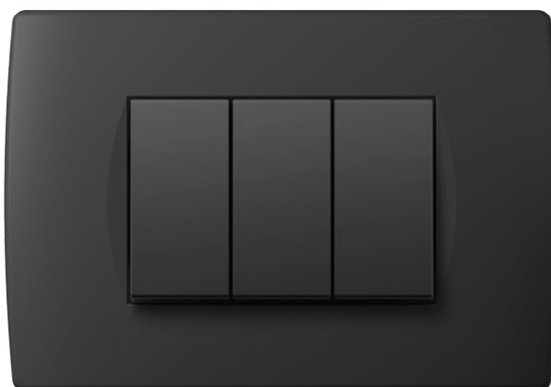

AT antracit  
anthracite



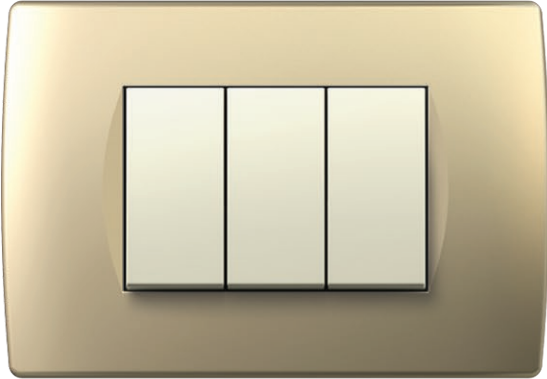
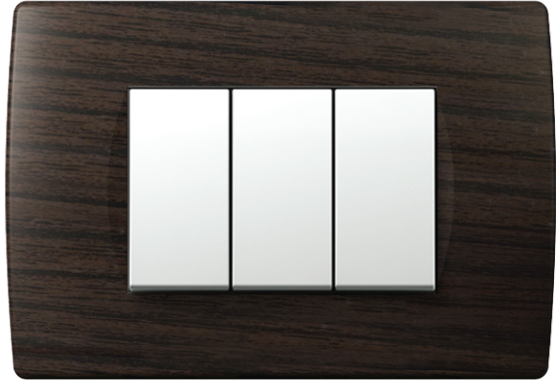

## COVER PLATES SOFT OS

dekor  
decorSG e artë ranore  
sand goldNB e zezë mesnate  
night blackTI titan  
titaniumWE venge  
wengeWW arrë  
walnut

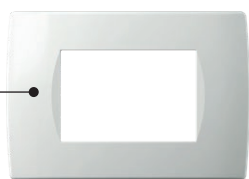

OS30



PW

lloji type	përshkrimi description	madhësia size	ngjyra colour
OS10	KAPAK MBULUES SOFT COVER PLATE SOFT	1/2M	PW e bardhë polare polar white
OS13	KAPAK MBULUES SOFT COVER PLATE SOFT	1/3M	IW e bardhë fildishi ivory white
OS20	KAPAK MBULUES SOFT COVER PLATE SOFT	2M	ES e argjendtë elox elox silver
...	...	...	SB e zezë soft touch soft touch black



OS20PW	OS20SG
OS20IW	OS20NB
OS20ES	OS20AT
OS20SB	OS20TI
	OS20WW
	OS20WE

#### KAPAK MBULUES SOFT 2M

- kapak mbulues dekorativ SOFT 2M  
- në përputhje me EN 60669-1

#### COVER PLATE SOFT 2M

- decorative cover plate SOFT 2M  
- in accordance with EN 60669-1



OS24PW	OS24SG
OS24IW	OS24NB
OS24ES	OS24AT
OS24SB	OS24TI
	OS24WW
	OS24WE

#### KAPAK MBULUES SOFT 2x2M

- kapak mbulues dekorativ SOFT 2x2M  
- montim horizontal ose vertikal  
- në përputhje me EN 60669-1

#### COVER PLATE SOFT 2x2M

- decorative cover plate SOFT 2x2M  
- horizontal or vertical mounting  
- in accordance with EN 60669-1

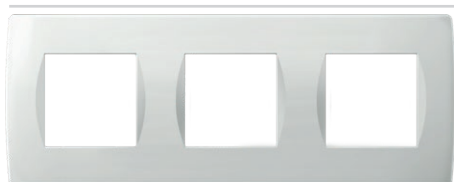

OS26PW	OS26SG
OS26IW	OS26NB
OS26ES	OS26AT
OS26SB	OS26TI
	OS26WW
	OS26WE

#### KAPAK MBULUES SOFT 3x2M

- kapak mbulues dekorativ SOFT 3x2M  
- montim horizontal ose vertikal  
- në përputhje me EN 60669-1

#### COVER PLATE SOFT 3x2M

- decorative cover plate  
SOFT 3x2M  
- horizontal or vertical mounting  
- in accordance with EN 60669-1



OS28PW	OS28SG
OS28IW	OS28NB
OS28ES	OS28AT
OS28SB	OS28TI
	OS28WW
	OS28WE

#### KAPAK MBULUES SOFT 4x2M

- kapak mbulues dekorativ SOFT 4x2M  
- montim horizontal ose vertikal  
- në përputhje me EN 60669-1

#### COVER PLATE SOFT 4x2M

- decorative cover plate  
SOFT 4x2M  
- horizontal or vertical mounting  
- in accordance with EN 60669-1

MODUL

SOFT

## COVER PLATES SOFT OS

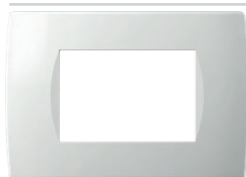

 OS30PW	 OS30SG
 OS30IW	 OS30NB
 OS30ES	 OS30AT
 OS30SB	 OS30TI
	 OS30WW
	 OS30WE

## KAPAK MBULUES SOFT 3M

- kapak mbulues dekorativ SOFT 3M  
- në përputhje me EN 60669-1

## COVER PLATE SOFT 3M

- decorative cover plate SOFT 3M  
- in accordance with EN 60669-1



 OS40PW	 OS40SG
 OS40IW	 OS40NB
 OS40ES	 OS40AT
 OS40SB	 OS40TI
	 OS40WW
	 OS40WE





## KAPAK MBULUES SOFT 4M

- kapak mbulues dekorativ SOFT 4M  
- në përputhje me EN 60669-1

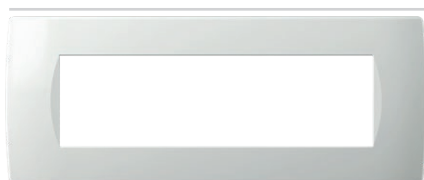
## COVER PLATE SOFT 4M

- decorative cover plate SOFT 4M  
- in accordance with EN 60669-1



 OS70PW	 OS70SG
 OS70IW	 OS70NB
 OS70ES	 OS70AT
 OS70SB	 OS70TI
	 OS70WW
	 OS70WE







## KAPAK MBULUES SOFT 7M

- kapak mbulues dekorativ SOFT 7M  
- në përputhje me EN 60669-1

## COVER PLATE SOFT 7M

- decorative cover plate SOFT 7M  
- in accordance with EN 60669-1



 OS72PW	 OS72AT
 OS72IW	 OS72TI
 OS72ES	
 OS72SB	







## KAPAK MBULUES SOFT 2x7M

- kapak mbulues dekorativ SOFT 7x2M  
me pllakë me mbishkrim  
- në përputhje me EN 60669-1

## COVER PLATE SOFT 2x7M

- decorative cover plate SOFT 2x7M  
with inscription plate  
- in accordance with EN 60669-1



 OS10PW	 OS10SG
 OS10IW	 OS10NB
 OS10ES	 OS10AT
 OS10SB	 OS10TI
	 OS10WW
	 OS10WE



## KAPAK MBULUES SOFT 1/2M

- kapak mbulues dekorativ SOFT 1/2M  
- në përputhje me EN 60669-1

## COVER PLATE SOFT 1/2M

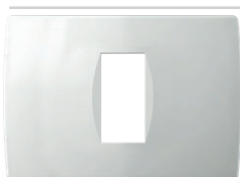
- decorative cover plate SOFT 1/2M  
- in accordance with EN 60669-1



 OS13PW	 OS13SG
 OS13IW	 OS13NB
 OS13ES	 OS13AT
 OS13SB	 OS13TI
	 OS13WW
	 OS13WE

## KAPAK MBULUES SOFT 1/3M

- kapak mbulues dekorativ SOFT 1/3M  
- në përputhje me EN 60669-1

## COVER PLATE SOFT 1/3M

- decorative cover plate SOFT 1/3M  
- in accordance with EN 60669-1

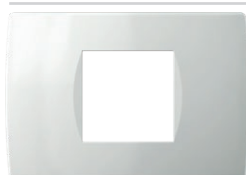

 OS23PW	 OS23SG
 OS23IW	 OS23NB
 OS23ES	 OS23AT
 OS23SB	 OS23TI
	 OS23WW
	 OS23WE

## KAPAK MBULUES SOFT 2/3M

- kapak mbulues dekorativ SOFT 2/3M  
- në përputhje me EN 60669-1

## COVER PLATE SOFT 2/3M

- decorative cover plate SOFT 2/3M  
- in accordance with EN 60669-1

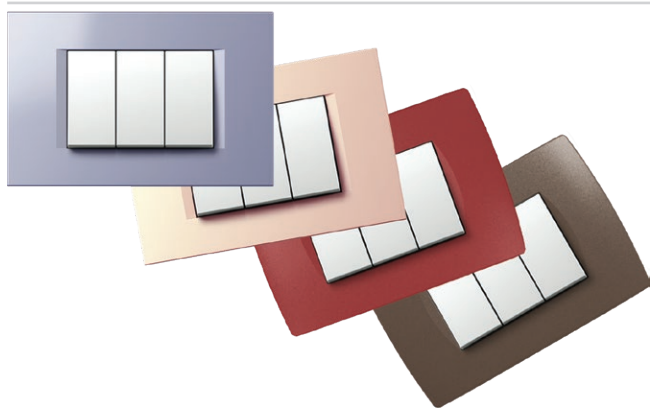











#### ZBUKURIMET E KAPAKËVE MBULUES

- kur porosisni sasi të mëdha, kapakët mbulues mund të bëhen në ngjyrën që ju zgjidhni
- i përshtatshëm për kapakët mbulues OL, OS

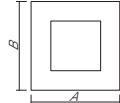
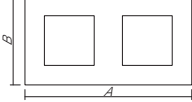
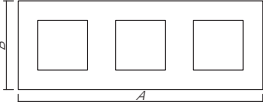
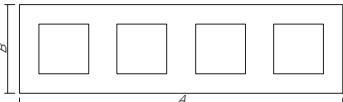
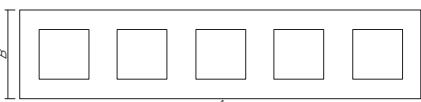
#### *COVER PLATES DECORATIONS*

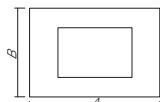
- when ordering large quantities, cover plates can be made in the colour of your choice
- suitable for cover plates OL, OS

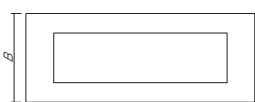
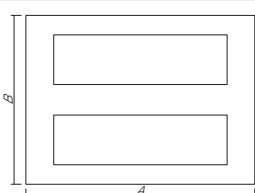
F R A M E S

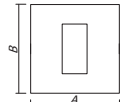
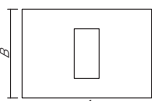
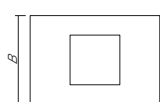
	 MODUL LINE A x B	 MODUL SOFT A x B	 MODUL PURE A x B
2M 	80 x 80 mm	84 x 84 mm	93 x 90 mm
2x2M 	151 x 80 mm	155 x 84 mm	164 x 90 mm
3x2M 	222 x 80 mm	226 x 84 mm	235 x 90 mm
4x2M 	293 x 80 mm	297 x 84 mm	304 x 90 mm
5x2M 	364,1 x 80 mm		
			
3M 	122 x 80 mm	122 x 84 mm	134 x 90 mm
4M 	149 x 80 mm	144 x 84 mm	157 x 90 mm
7M 	207 x 80 mm	212 x 84 mm	224 x 90 mm
2x7M 		212 x 158 mm	
			
1/2M 	80 x 80 mm	84 x 84 mm	
1/3M 	122 x 80 mm	122 x 84 mm	134 x 90 mm
2/3M 	122 x 80 mm	122 x 84 mm	134 x 90 mm

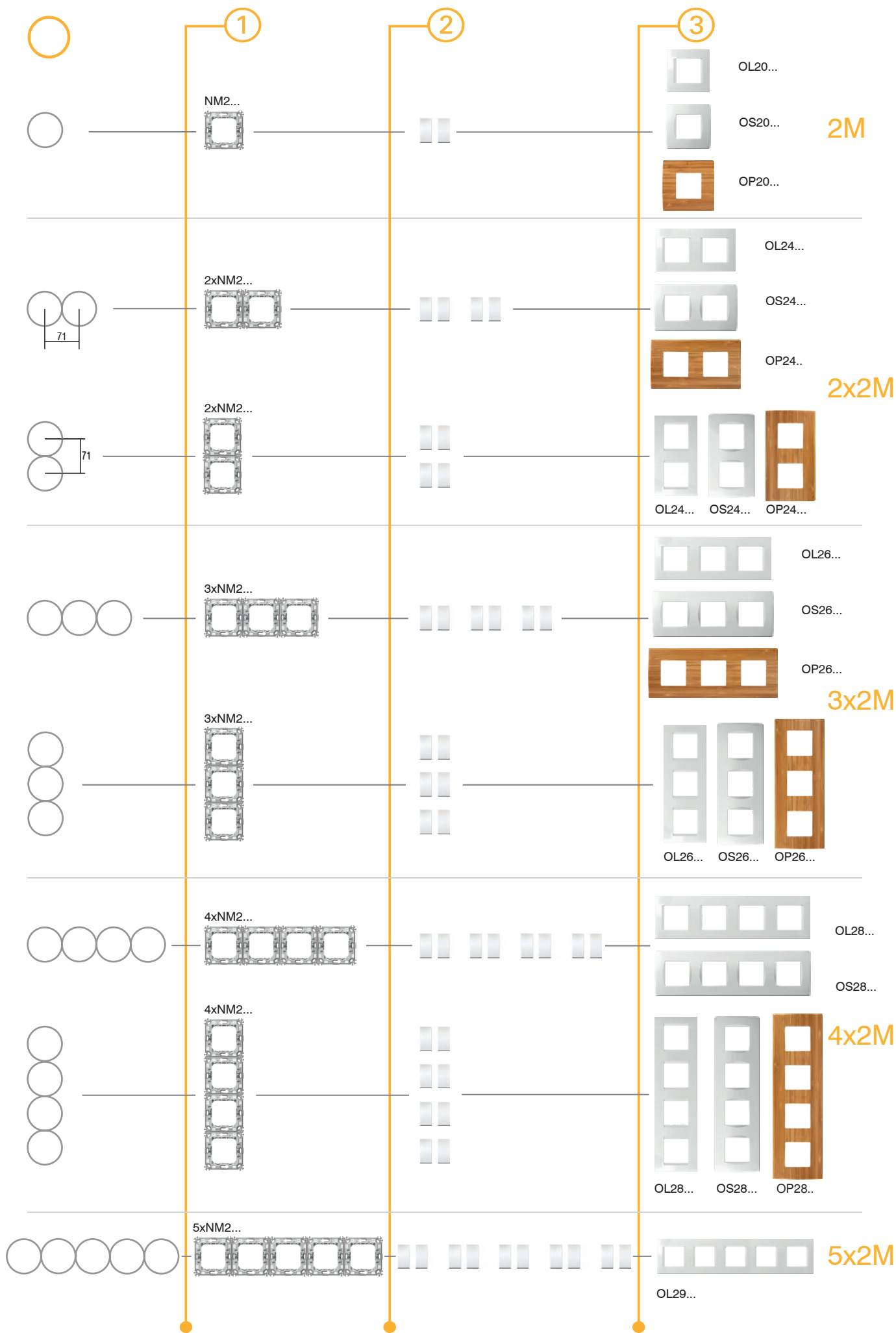

C O M B I N A T I O N S

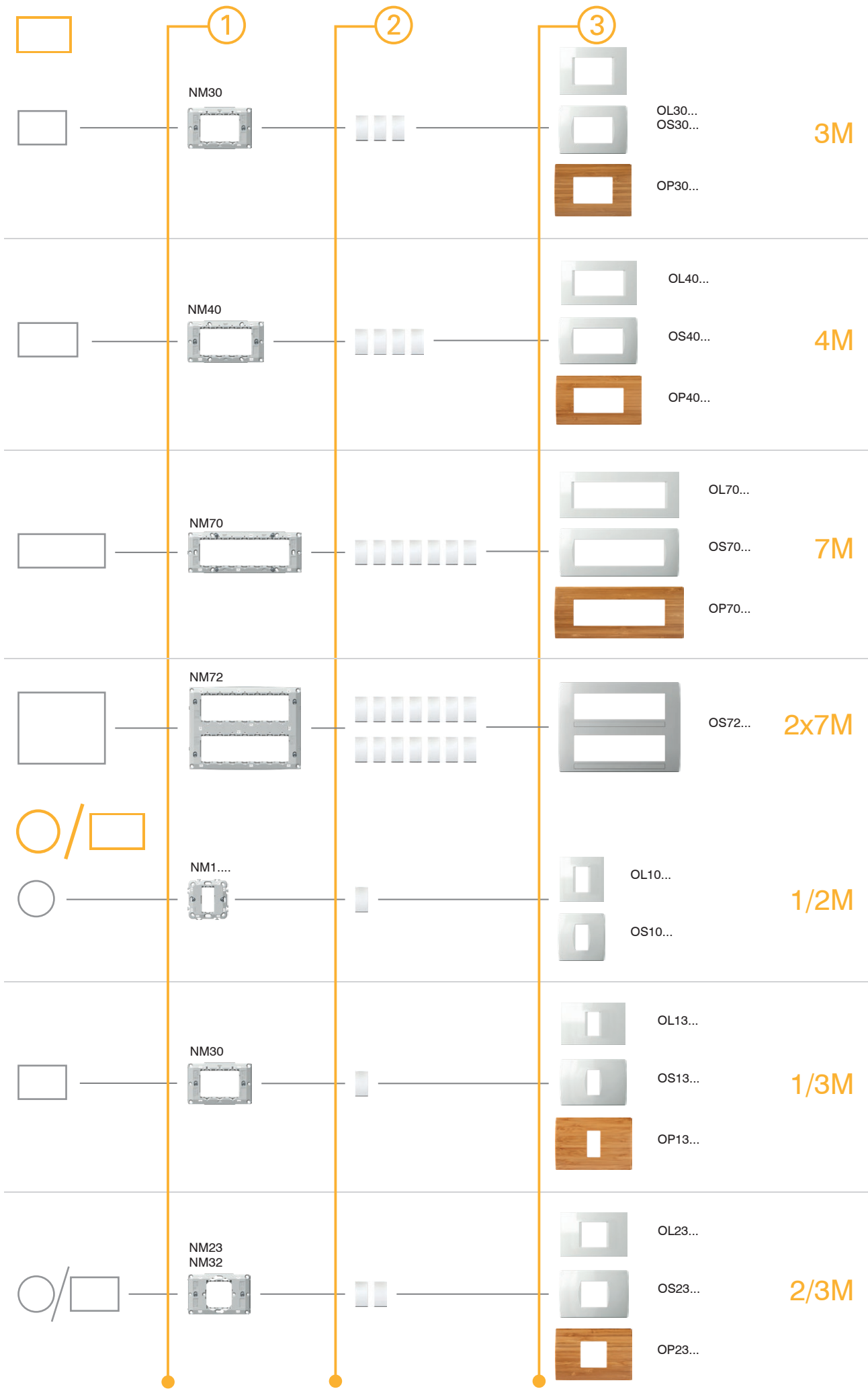

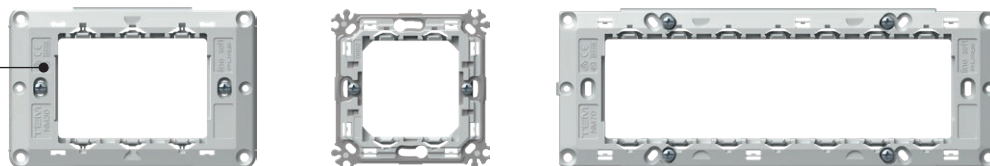

NM30

Iloji type	përshkrimi description	madhësia size
NM10	KORNIZË MONTIMI ME KTHETRA MOUNTING FRAME WITH CLAWS	1/2M
NM11	KORNIZË MONTIMI PA VIDA MOUNTING FRAME WITHOUT SCREWS	1/2M
NM20	KORNIZË MONTIMI ME KTHETRA MOUNTING FRAME WITH CLAWS	2M
...	...	...



KORNIZË MONTIMI ME KTHETRA 2M

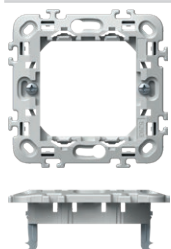

NM20

- kornizë montimi 2M me kthetra
- për montimin në kutitë Ø60 (DE..) me kthetra
- kombinime të mundshme horizontale ose vertikale 2x2M, 3x2M dhe 4x2M
- i përshatshëm për montimin me kapakët mbulues LINE dhe SOFT
- në përputhje me EN 60669-1

MOUNTING FRAME WITH CLAWS 2M

- mounting frame 2M with claws
- for mounting on boxes Ø60 (DE..) with claws
- possible horizontal or vertical combinations 2x2M, 3x2M and 4x2M
- suitable for assembling with cover plates LINE and SOFT
- in accordance with EN 60669-1

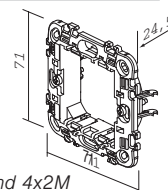

KORNIZË MONTIMI PA VIDA 2M

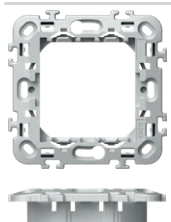

NM21

- kornizë montimi 2M pa vida dhe pa kthetra
- për montimin në kutitë Ø60 (HE..., DE..) me vida
- kombinime të mundshme horizontale ose vertikale 2x2M, 3x2M dhe 4x2M
- i përshatshëm për montimin me kapakët mbulues LINE dhe SOFT
- në përputhje me EN 60669-1

MOUNTING FRAME WITHOUT SCREWS 2M

- mounting frame 2M without screws and without claws
- for mounting on boxes Ø60 (HE..., BE..) with screws
- possible horizontal or vertical combinations 2x2M, 3x2M and 4x2M
- suitable for assembling with cover plates LINE and SOFT
- in accordance with EN 60669-1

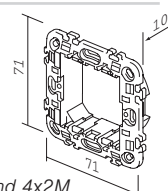

KORNIZË MONTIMI METALIKE ME KTHETRA 2M

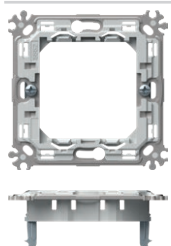

NM24

- kornizë montimi metalike 2M me kthetra - versioni i fortë
- për montimin në kutitë Ø60 (DE..) me kthetra
- kombinime të mundshme horizontale ose vertikale 2x2M, 3x2M dhe 4x2M
- i përshatshëm për montimin me kapakët mbulues PURE, LINE dhe SOFT
- në përputhje me EN 60669-1

MOUNTING FRAME METAL WITH CLAWS 2M

- metal mounting frame 2M with claws - stiff version
- for mounting on boxes Ø60 (DE..) with claws
- possible horizontal or vertical combinations 2x2M, 3x2M and 4x2M
- suitable for assembling with cover plates PURE, LINE and SOFT
- in accordance with EN 60669-1

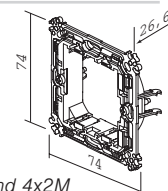

KORNIZË MONTIMI METALIKE PA VIDA 2M

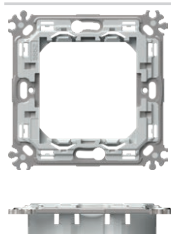

NM25

- kornizë montimi metalike me vida dhe pa kthetra - versioni i fortë
- për montimin në kutitë Ø60 (HE... BE...) me vida
- kombinime të mundshme horizontale ose vertikale 2x2M, 3x2M dhe 4x2M
- i përshatshëm për montimin me kapakët mbulues PURE, LINE dhe SOFT
- në përputhje me EN 60669-1

MOUNTING FRAME METAL WITHOUT SCREWS 2M

- metal mounting frame 2M without screws and without claws - stiff version
- for mounting in boxes Ø60 (HE..., BE...) with screws
- possible horizontal or vertical combinations 2x2M, 3x2M and 4x2M
- suitable for assembling with cover plates PURE, LINE and SOFT
- in accordance with EN 60669-1

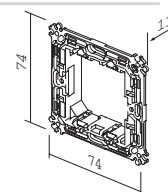



## M O U N T I N G   F R A M E S   N M

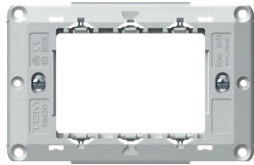

NM30

## KORNIZË MONTIMI ME VIDA 3M

- kornizë montimi 3M me vida
- për montim në kutitë drejtkëndore 3M
- i përshtatshëm për montimin me kapakët mbulues PURE, LINE dhe SOFT
- në përputhje me EN 60669-1

*MOUNTING FRAME WITH SCREWS 3M*

- mounting frame 3M with screws
- for mounting on rectangular boxes 3M
- suitable for assembling with cover plates PURE, LINE and SOFT
- in accordance with EN 60669-1

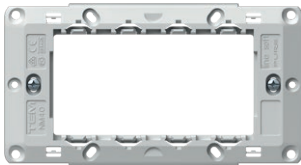
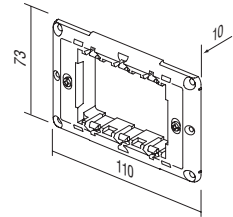

NM40

## KORNIZË MONTIMI ME VIDA 4M

- kornizë montimi 4M me vida
- për montim në kutitë drejtkëndore 4M
- i përshtatshëm për montimin me kapakët mbulues PURE, LINE dhe SOFT
- në përputhje me EN 60669-1

*MOUNTING FRAME WITH SCREWS 4M*

- mounting frame 4M with screws
- for mounting on rectangular boxes 4M
- suitable for assembling with cover plates PURE, LINE and SOFT
- in accordance with EN 60669-1

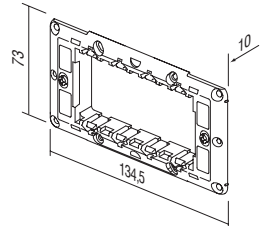

NM70

## KORNIZË MONTIMI ME VIDA 7M

- kornizë montimi 7M me vida
- për montim në kutitë drejtkëndore 7M
- i përshtatshëm për montimin me kapakët mbulues PURE LINE DHE SOFT
- në përputhje me EN 60669-1

*MOUNTING FRAME WITH SCREWS 7M*

- mounting frame 7M with screws
- for mounting on rectangular boxes 7M
- suitable for assembling with cover plates PURE, LINE and SOFT
- in accordance with EN 60669-1

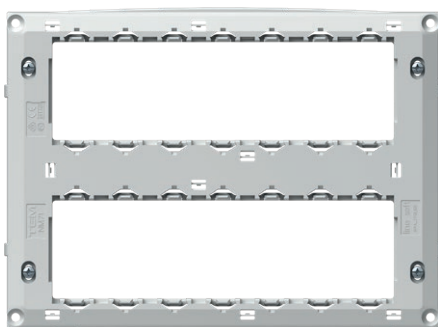
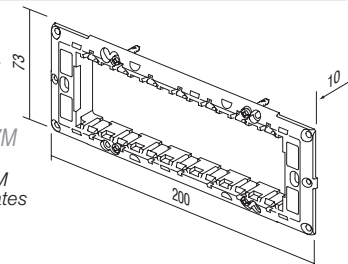

NM72

## KORNIZË MONTIMI ME VIDA 2x7M

- kornizë montimi me vida 2x7M
- për montim në kutitë drejtkëndore 2x7M
- i përshtatshëm për montimin me kapak mbulues SOFT OS72
- në përputhje me EN 60669-1

*MOUNTING FRAME WITH SCREWS 2x7M*

- mounting frame 2x7M with screws
- for mounting on rectangular boxes 2x7M
- suitable for assembling with cover plate SOFT OS72
- in accordance with EN 60669-1

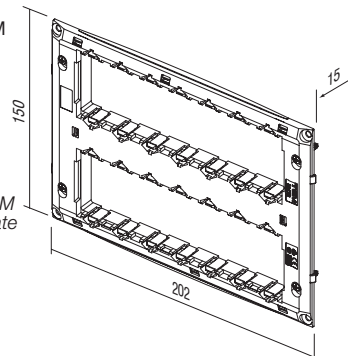



**KORNIZË MONTIMI ME KTHETRA 1/2M**

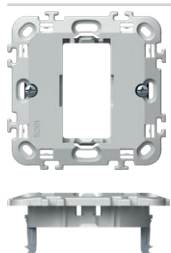

NM10

- kornizë montimi 1/2M me kthetra
- për montimin në kutitë Ø60 (DE..) me kthetra
- i përshtatshëm për montimin me kapakët mbulues LINE dhe SOFT
- në përputhje me EN 60669-1

**MOUNTING FRAME WITH CLAWS 1/2M**

- mounting frame 1/2M with claws
- for mounting on boxes Ø60 (DE..) with claws
- suitable for assembling with cover plates LINE and SOFT
- in accordance with EN 60669-1

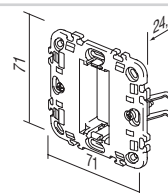

**KORNIZË MONTIMI PA VIDA 1/2M**

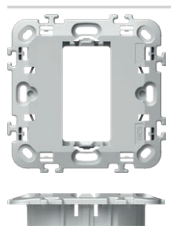

NM11

- kornizë montimi 1/2M pa vida dhe pa kthetra
- për montimin në kutitë Ø60 (HE.., DE..) me vida
- i përshtatshëm për montimin me kapakët mbulues LINE dhe SOFT
- në përputhje me EN 60669-1

**MOUNTING FRAME WITHOUT SCREWS 1/2M**

- mounting frame 1/2M without screws and without claws
- for mounting on boxes Ø60 (HE.., BE..) with screws
- suitable for assembling with cover plates LINE and SOFT
- in accordance with EN 60669-1

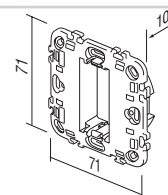

**KORNIZË MONTIMI ME KTHETRA 2/3M**

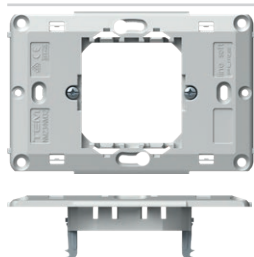

NM23

- kornizë montimi 2/3M me kthetra
- për montimin në kutitë Ø60 (DE..) me kthetra
- i përshtatshëm për montimin me kapakët mbulues PURE, LINE dhe SOFT
- në përputhje me EN 60669-1

**MOUNTING FRAME WITH CLAWS 2/3M**

- mounting frame 2/3M with claws
- for mounting on boxes Ø60 (DE..) with claws
- suitable for assembling with cover plates PURE, LINE and SOFT
- in accordance with EN 60669-1

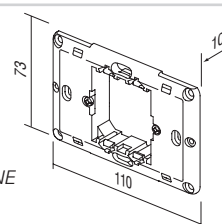

**KORNIZË MONTIMI ME VIDA 2/3M**

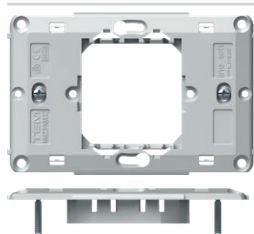

NM32

- kornizë montimi 2/3M me vida
- për montim në kutitë drejtkëndore 3M
- i përshtatshëm për montimin me kapakët mbulues PURE, LINE dhe SOFT
- në përputhje me EN 60669-1

**MOUNTING FRAME WITH SCREWS 2/3M**

- mounting frame 2/3M with screws
- for mounting on rectangular boxes 3M
- suitable for assembling with cover plates PURE, LINE and SOFT
- in accordance with EN 60669-1

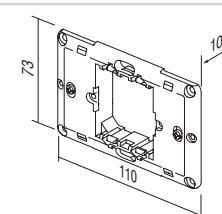





110



118



126



128





## KUTITĚ

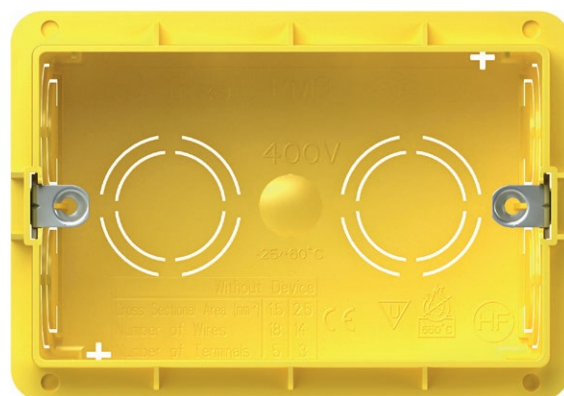

**TEM**

# K U T I T Ë E R R U M B U L L A K Ë T A



DE12



HE11



BE10

lloji type	përshkrimi description	madhësia size
DE10	KUTI E RRUMBULLAKËT TULLË ROUND BOX BRICK	SM60-01
HE10	KUTI E RRUMBULLAKËT MUR BOSH ROUND BOX HOLLOW WALL	SM68X40
BE10	KUTI E RRUMBULLAKËT BETON ROUND BOX CONCRETE	
⋮	⋮	⋮

## KUTI E RRUMBULLAKËT TULLË SM60-01



DE10

- Ø60, thellësia 40 mm
- 650°C, 500 V~
- në përputhje me IEC 60670-1
- pa halogjenë
- opsioni i montimit të kornizës së montimit me vidë Ø 3 mm

### ROUND BOX BRICK SM60-01

- Ø60, depth 40mm
- 650°C, 500V~
- in accordance with IEC 60670-1
- halogen free
- option of mounting the mounting frame with Ø 3 mm screws

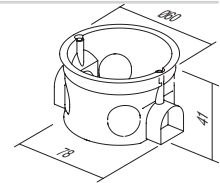

## KUTI E RRUMBULLAKËT TULLË E THELLË SM60-06



DE11

- Ø60, thellësia 60mm
- 650°C, 500 V~
- në përputhje me IEC 60670-1
- pa halogjenë
- opsioni i montimit të kornizës së montimit me vidë Ø 3 mm

### ROUND BOX BRICK DEEP SM60-06

- Ø60, depth 60mm
- 650°C, 500V~
- in accordance with IEC 60670-1
- halogen free
- option of mounting the mounting frame with Ø 3 mm screws

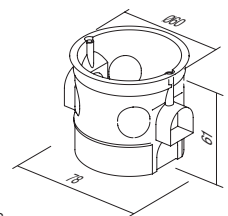

## KAPËSE E KOMBINUAR SM60-03



DE30

- për montimin vertikal të kutive SM60-06 ose SM60-01
- në distancë prej 91 mm
- në përputhje me IEC 60670-1
- pa halogjenë

### COMBI-CLIP SM60-03

- for vertical fitting of boxes SM60-06 or SM60-01 on distance 91 mm
- in accordance with IEC 60670-1
- halogen free

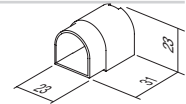

## KAPËSE E KOMBINUAR SM60-04

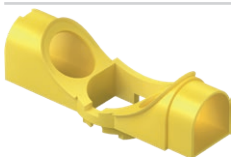

DE31







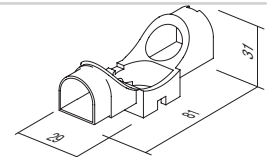



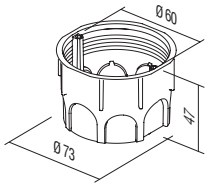

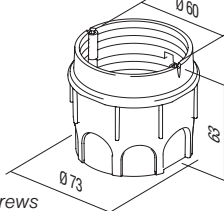
- për montimin horizontal të kutive SM60-06 ose SM60-01
- në distancë prej 71mm
- në përputhje me IEC 60670-1
- pa halogjenë

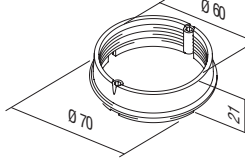
### COMBI-CLIP SM60-04

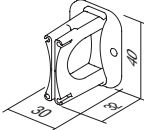
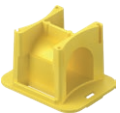
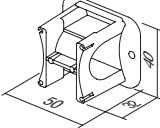
- for horizontal fitting of boxes SM60-06 or SM60-01 on distance 71mm
- in accordance with IEC 60670-1
- halogen free

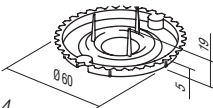

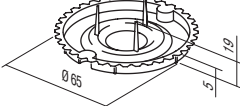
## R O U N D     B O X E S

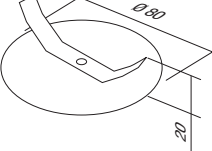
	DE12	<b>KUTI E RRUMBULLAKËT TULLË MD65-46</b> - Ø65, thellësia 46 mm - 650 °C, 500 V~ - në përputhje me IEC 60670-1 - pa halogjenë - opsioni i montimit të kornizës së montimit me vidë Ø 3 mm	
		<b>ROUND BOX BRICK MD65-46</b> - Ø65, depth 46mm - 650°C, 500V~ - in accordance with IEC 60670-1 - halogen free - option of mounting the mounting frame with Ø 3 mm screws	
	DE13	<b>KUTI E RRUMBULLAKËT TULLË E THELLË MD65-60</b> - Ø65/60, thellësia 62 mm - 650 °C, 500 V~ - në përputhje me IEC 60670-1 - pa halogjenë - opsioni i montimit të kornizës së montimit me vidë Ø 3 mm	
		<b>ROUND BOX BRICK DEEP MD65-60</b> - Ø65/60, depth 62mm - 650°C, 500V~ - in accordance with IEC 60670-1 - halogen free - option of mounting the mounting frame with Ø 3 mm screws	
	DE14	<b>PJESË SHITESË PËR MD65-46</b> - Ø65/60, thellësia 17mm - 650 °C, 500 V~ - në përputhje me IEC 60670-1 - pa halogjenë	
		<b>ADDITIONAL PIECE FOR MD65-46</b> - Ø65/60, depth 17mm - 650°C, 500V~ - in accordance with IEC 60670-1 - halogen free	
	DE32	<b>KAPËSE E KOMBINUAR MD65-71</b> - për montimin e kutive MD65 në distancë prej 71 mm - në përputhje me IEC 60670-1 - pa halogjenë	
		<b>COMBI-CLIP MD65-71</b> - for fitting of boxes MD65 on distance 71mm - in accordance with IEC 60670-1 - halogen free	
	DE33	<b>KAPËSE E KOMBINUAR MD65-91</b> - për montimin e kutive MD65 në distancë prej 91mm - në përputhje me IEC 60670-1 - pa halogjenë	
		<b>COMBI-CLIP MD65-91</b> - for fitting of boxes MD65 on distance 91mm - in accordance with IEC 60670-1 - halogen free	
	DE20	<b>KAPAK MBROJTËS PËR KUTI 60</b> - kapak mbrojtës për kuti Ø60 për DE10, DE11, DE13, DE14 - në përputhje me IEC 60670-1 - mbrojtje për kuti gjatë suvatimit	
		<b>BOX COVER PROTECTIVE 60</b> - protective cover for box Ø60 for DE10, DE11, DE13, DE14 - in accordance with IEC 60670-1 - box protection during plastering	
	DE21	<b>KAPAK MBROJTËS PËR KUTI 65</b> - kapak mbrojtës për kuti Ø65 për DE12 - në përputhje me IEC 60670-1 - mbrojtje për kuti gjatë suvatimit	
		<b>BOX COVER PROTECTIVE 65</b> - protective cover for box Ø65 for DE12 - in accordance with IEC 60670-1 - box protection during plastering	
	DE22	<b>KAPAK DEKORATIV PËR KUTI SM60</b> - kapak dekorativ për kuti Ø60 - në përputhje me IEC 60670-1 - pa halogjenë	
		<b>BOX COVER DECORATIVE SM60</b> - decorative cover for boxes Ø60 - in accordance with IEC 60670-1 - halogen free	

# K U T I T Ë E R R U M B U L L A K Ë T A



udhëzime për montimin /  
assembly instructions

distanca mes kutive /  
distance between boxes: 71mm

distanca mes kutive /  
distance between boxes: 91mm

DE10,11

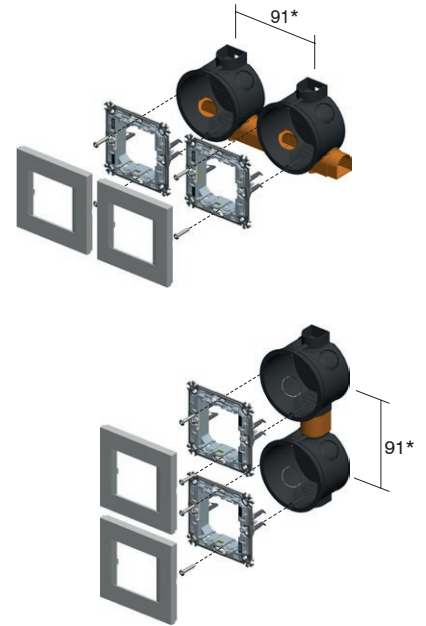
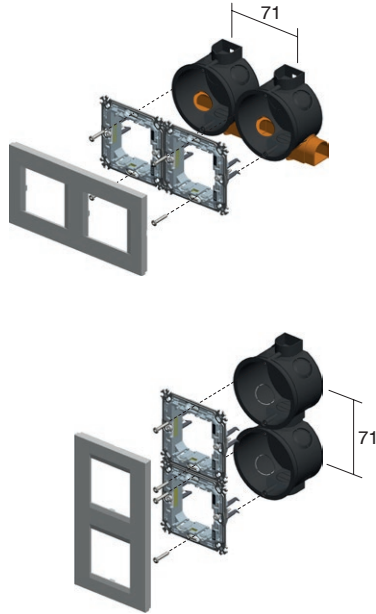
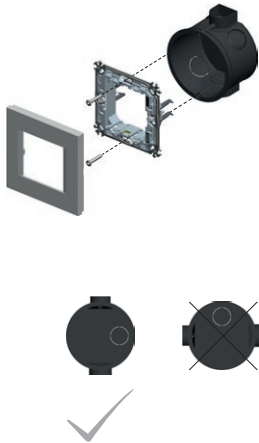

DE12,13

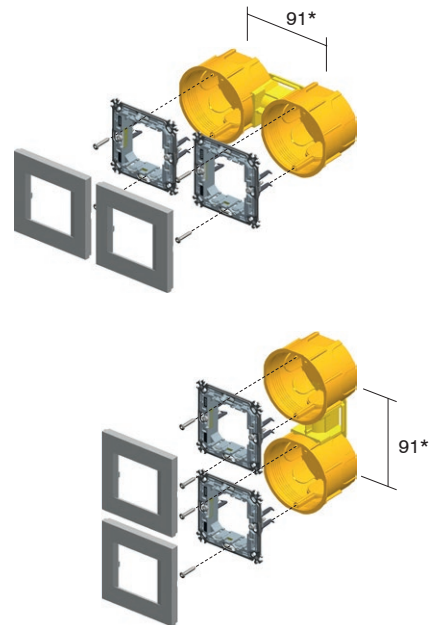
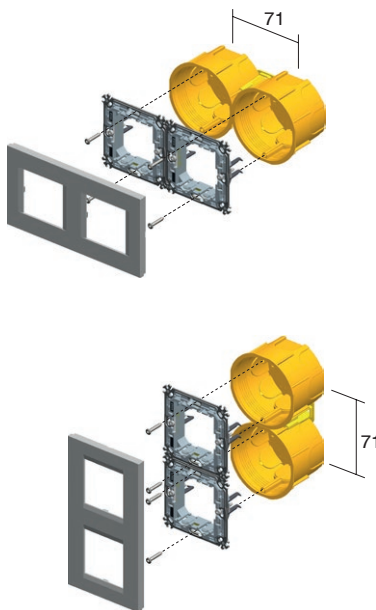
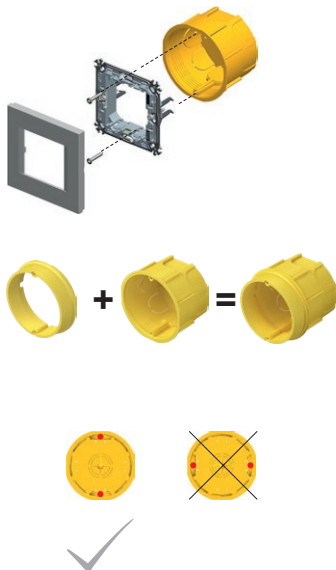

\* për kapakët mbulues PURE distanca minimale mes kutive është 100 mm  
\* for PURE cover plates the minimum distance between boxes is 100mm



R O U N D     B O X E S



DE10,11



DE12,13



NM20



NM24



DE10,11



DE12,13



NM10



DE10,11



DE12,13



NM23



71

2xDE10,11 + 2xDE31



2xDE12,13 + 1xDE32



2xNM20



2xNM24



2xDE10,11    2xDE12,13 + 1xDE32



2xNM20    2xNM24



3xDE10,11 + 3xDE31



3xDE12,13 + 2xDE32



3xNM20



3xNM24



3xDE10,11    3xDE12,13 + 2xDE32

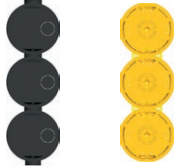

3xNM20    3xNM24



4xDE10,11 + 4xDE31



4xDE12,13 + 3xDE32



4xNM20



4xNM24



4xDE10,11    4xDE12,13 + 3xDE32

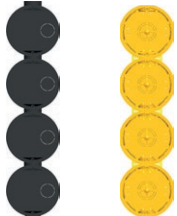

4xNM20    4xNM24



5xDE10,11



5xNM20



5xDE12,13 + 4xDE32



5xNM24



**KUTI E RRUMBULLAKËT MUR BOSH SM68x40**



HE10

- Ø60, thellësia 40 mm
- vrima e prerjes Ø68
- 850°C, 400V~
- në përputhje me IEC 60670-1
- montim me kthetra
- pa halogjenë
- montimi i kornizës së montimit me vidë Ø 3 mm

**ROUND BOX HOLLOW WALL SM68x40**

- Ø60, depth 40mm
- cutting hole Ø68
- 850°C, 400V~
- in accordance with IEC 60670-1
- mounting with claws
- halogen free
- mounting the mounting frame with Ø 3 mm screws

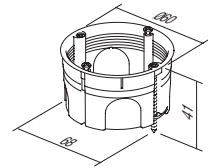

**KUTI E RRUMBULLAKËT MUR BOSH SM68x55**



HE11

- Ø60, thellësia 55mm
- vrima e prerjes Ø68
- 850°C, 400V~
- në përputhje me IEC 60670-1
- montim me kthetra
- pa halogjenë
- montimi i kornizës së montimit me vidë Ø 3 mm

**ROUND BOX HOLLOW WALL SM68x55**

- Ø60, depth 55mm
- cutting hole Ø68
- 850°C, 400V~
- in accordance with IEC 60670-1
- mounting with claws
- halogen free
- mounting the mounting frame with Ø 3 mm screws

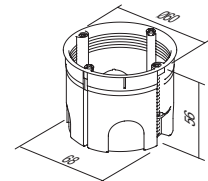

**KUTI E RRUMBULLAKËT BETON**



BE10

- Ø60, thellësia 49mm
- 650°C, 500 V~
- në përputhje me IEC 60670-1
- pa halogjenë
- montimi i kornizës së montimit me vidë Ø 3 mm

**ROUND BOX CONCRETE**

- Ø60mm, depth 49mm
- 650°C, 500V~
- in accordance with IEC 60670-1
- halogen free
- mounting the mounting frame with Ø 3 mm screws

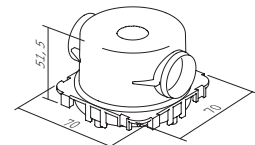

**KUTI E RRUMBULLAKËT BETON E THELLË**



BE11

- Ø60, thellësia 58mm
- 650°C, 500 V~
- në përputhje me IEC 60670-1
- pa halogjenë
- montimi i kornizës së montimit me vidë Ø 3 mm

**ROUND BOX CONCRETE DEEP**

- Ø60mm, depth 58mm
- 650°C, 500V~
- in accordance with IEC 60670-1
- halogen free
- mounting the mounting frame with Ø 3 mm screws

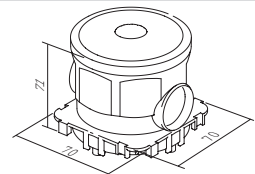

**KUNDËR-SUPORT KUTIE PËR BETON**



BE20

- për suportin e kutive për beton me profil në distancë BM82 muri përballë
- në përputhje me IEC 60670-1
- pa halogjenë

**COUNTER BOX SUPPORT CONCRETE**

- to support concrete boxes with discance profile BM82 for extreme loads
- in accordance with IEC 60670-1
- halogen free

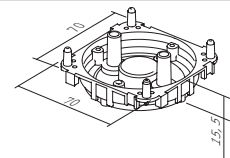

**KUTI PËR BETON PËR BLOKUES TUBI 16**



BE21

- për mbajtjen e tubit të instalimit në kuti
- në përputhje me IEC 60670-1
- pa halogjenë

**PIPE STOPPER CONCRETE BOX 16**

- for firming installation pipe to box
- in accordance with IEC 60670-1
- halogen free

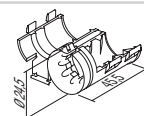

R O U N D B O X E S

mure bosh / hollow walls



beton / concrete



udhëzime për montimin /  
assembly instructions

distanca mes kutive /  
distance between boxes: 71mm

distanca mes kutive /  
distance between boxes: 91mm

HE10,11

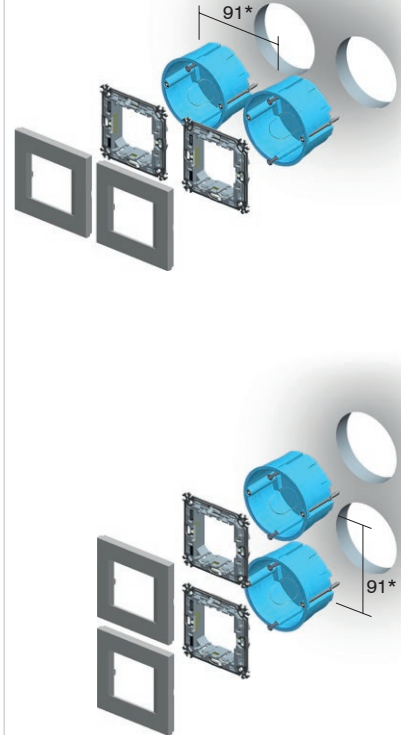
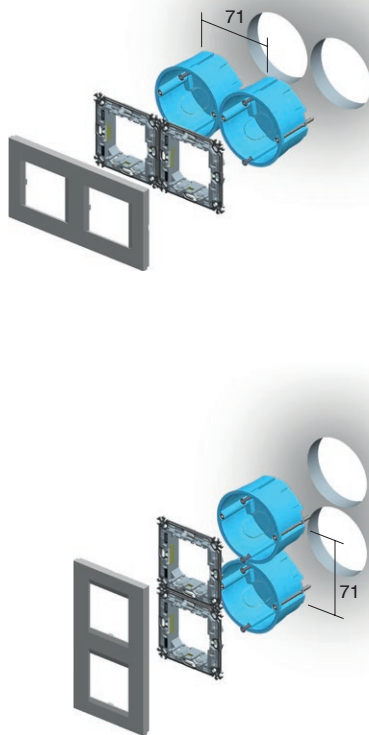
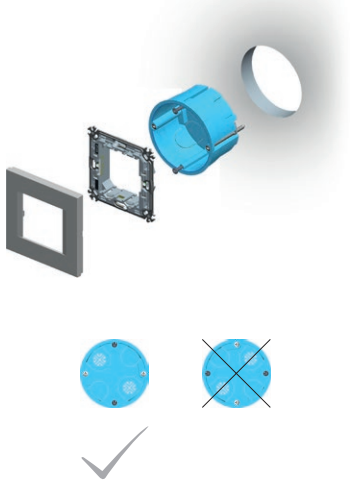

BE10

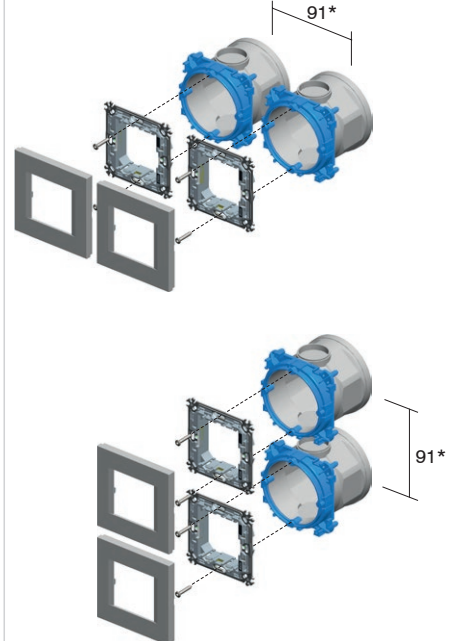
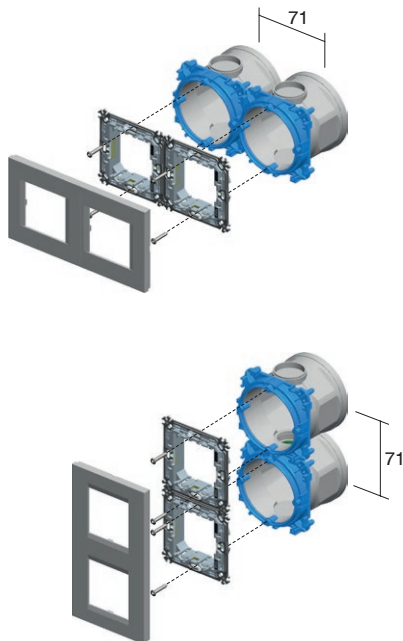
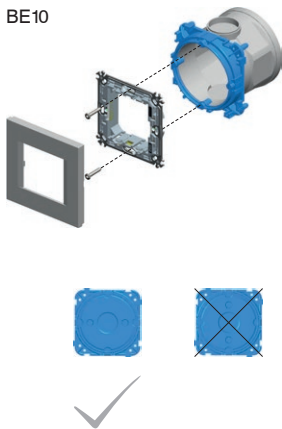

\* për kapakët mbulues PURE distanca minimale mes kutive është 100 mm  
\* for PURE cover plates the minimum distance between boxes is 100mm

# K U T I T Ě E R R U M B U L L A K Ě T A

mure bosh / hollow walls



beton / concrete



HE10,11



BE10,11



NM21



NM25



2M

HE10,11



BE10,11



NM11



1/2M

2xHE10,11

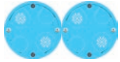

2xBE10,11



2xNM21



2xNM25



2x2M

HE10,11



BE10,11



NM32



2/3M

2xHE10,11



2xBE10,11



2xNM21



2xNM25

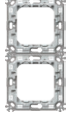

5xHE10,11



5xNM21



5xBE10,11



5xNM25



5x2M

3xHE10,11

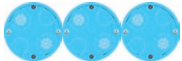

3xBE10,11



3xNM21



3xNM25



3x2M

3xHE10,11



3xBE10,11



3xNM21



3xNM25

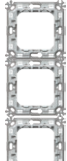

4xHE10,11



4xBE10,11



4xNM21



4xNM25



4x2M

4xHE10,11



4xBE10,11



4xNM21



4xNM25

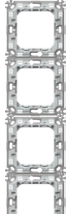

## R O U N D     B O X E S

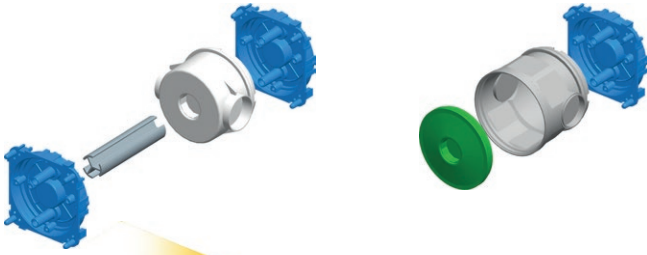

udhëzime për montimin /  
assembly instructions

1

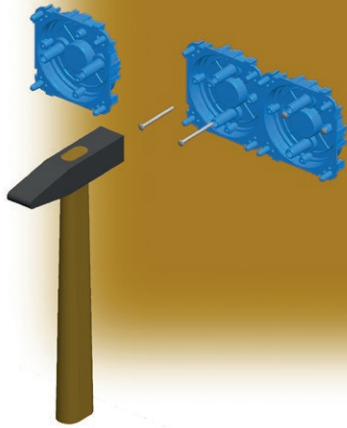

2

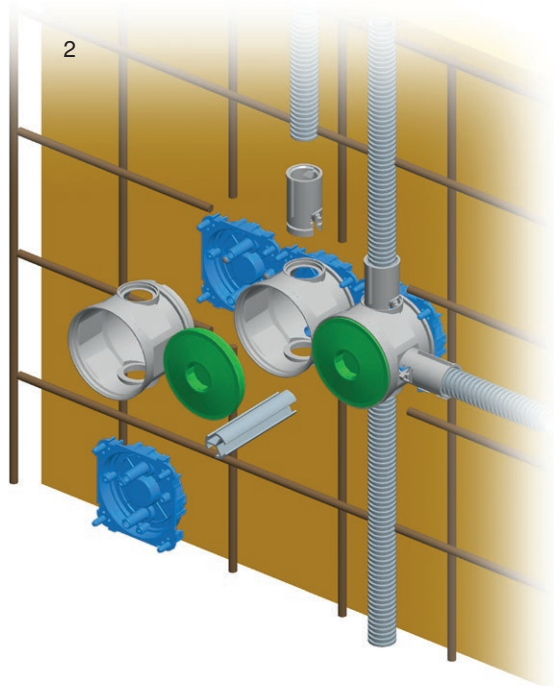

3

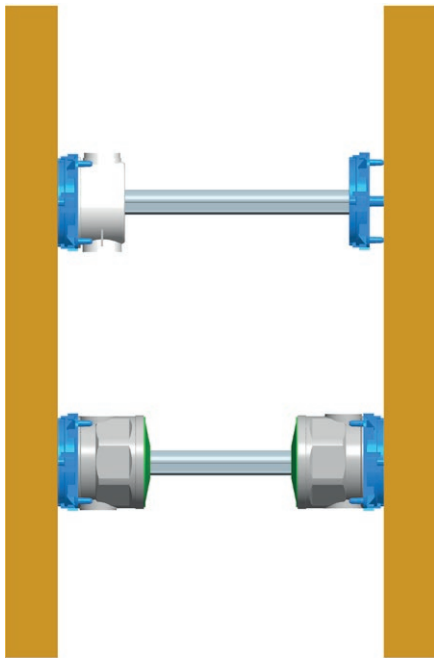

4

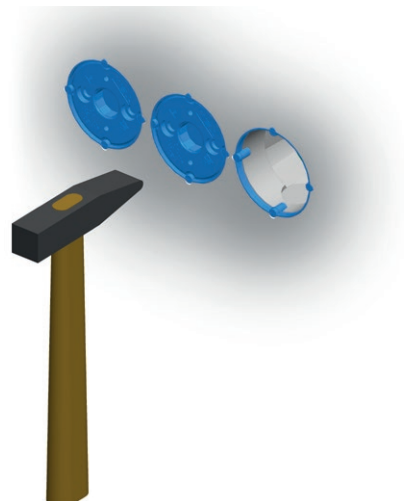



DM30



HM30



BM30

Iloji type	përshkrimi description	madhësia size
DM30	KUTI DREJTKËNDORE TULLË RECTANGULAR BOX BRICK	PM3
HM30	KUTI DREJTKËNDORE MUR BOSH RECTANGULAR BOX HOLLOW WALL	VM3
BM30	KUTI DREJTKËNDORE BETON RECTANGULAR BOX CONCRETE	BM3
·	·	·
·	·	·

KUTI DREJTKËNDORE TULLË PM3



DM30

- madhësia 3M, thellësia 49 mm
- 650°C, 400V~
- në përputhje me IEC 60670-1
- pa halogjenë

RECTANGULAR BOX BRICK PM3

- size 3M, depth 49mm
- 650°C, 400V~
- in accordance with IEC 60670-1
- halogen free

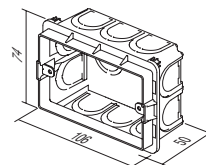

KUTI DREJTKËNDORE TULLË PM3-65



DM31

- madhësia 3M, thellësia 65mm
- 650°C, 400V~
- në përputhje me IEC 60670-1
- pa halogjenë

RECTANGULAR BOX BRICK PM3-65

- size 3M, depth 65mm
- 650°C, 400V~
- in accordance with IEC 60670-1
- halogen free

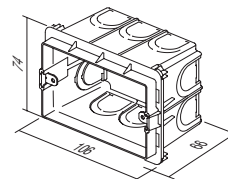

KUTI DREJTKËNDORE TULLË PM4



DM40

- madhësia 4M, thellësia 49 mm
- 650°C, 400V~
- në përputhje me IEC 60670-1
- pa halogjenë

RECTANGULAR BOX BRICK PM4

- size 4M, depth 49mm
- 650°C, 400V~
- in accordance with IEC 60670-1
- halogen free

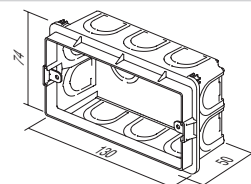

KUTI DREJTKËNDORE TULLË PM4-65



DM41

- madhësia 4M, thellësia 65mm
- 650°C, 400V~
- në përputhje me IEC 60670-1
- pa halogjenë

RECTANGULAR BOX BRICK PM4-65

- size 4M, depth 65mm
- 650°C, 400V~
- in accordance with IEC 60670-1
- halogen free

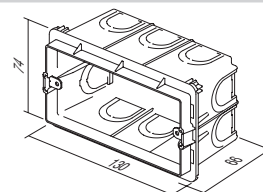

## R E C T A N G U L A R   B O X E S

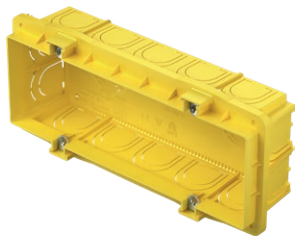

DM70

## KUTI DREJTKËNDORE TULLË PM7

- madhësia 7M, thellësia 49 mm
- 650°C, 400V~
- në përputhje me IEC 60670-1
- pa halogjenë

## RECTANGULAR BOX BRICK PM7

- size 7M, depth 49mm
- 650°C, 400V~
- in accordance with IEC 60670-1
- halogen free

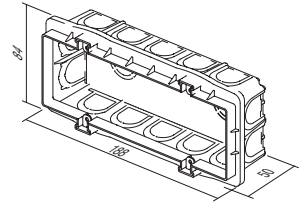

DM71

## KUTI DREJTKËNDORE TULLË PM7-65

- madhësia 7M, thellësia 65mm
- 650°C, 400V~
- në përputhje me IEC 60670-1
- pa halogjenë

## RECTANGULAR BOX BRICK PM7-65

- size 7M, depth 65mm
- 650°C, 400V~
- in accordance with IEC 60670-1
- halogen free

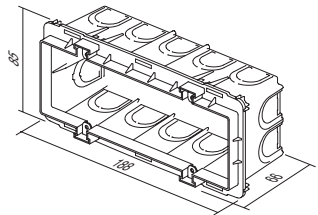

DM72

## KUTI DREJTKËNDORE TULLË PM72-65

- madhësia 2x7M, thellësia 64mm
- 650°C, 400V~
- në përputhje me IEC 60670-1
- pa halogjenë

## RECTANGULAR BOX BRICK PM72-65

- size 2x7M, depth 64mm
- 650°C, 400V~
- in accordance with IEC 60670-1
- halogen free

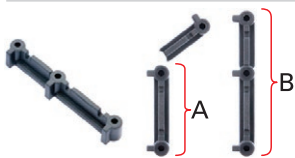
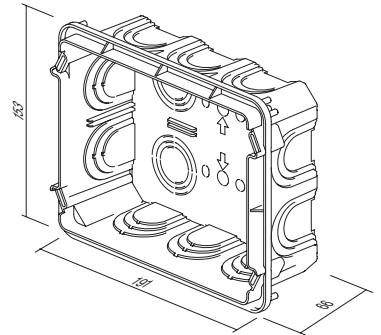

DM80

## PJESË DISTANCUESE PËR KUTI PM

- për montim vertikal (A) dhe horizontal (B)
- të kutive PM3, PM4 në PM7
- i përshtatshëm për kapakë mbulues dekorativë Line dhe Soft (jo për PURE)

## DISTANCE PIECE FOR BOX PM

- for vertical (A) and horizontal (B) fitting of boxes PM3, PM4 and PM7
- suitable for Line and Soft decorative cover plates (not for PURE)

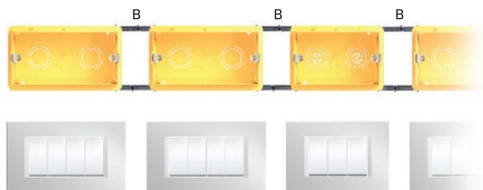
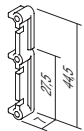



DM33

**KAPAK MBROJTËS PËR KUTI PM3**

- kapak mbrojtës për kuti PM3
- në përputhje me IEC 60670-1
- pa halogjenë
- mbrojtje për kuti gjatë suvatimit

*BOX COVER PROTECTIVE PM3*

- protective cover for box PM3
- in accordance with IEC 60670-1
- halogen free
- box protection during plastering

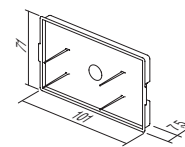

DM34

**KAPAK DEKORATIV PËR KUTI PM3**

- kapak dekorativ për kuti 3M
- vidat janë të përfshira
- në përputhje me IEC 60670-1
- pa halogjenë

*BOX COVER DECORATIVE PM3*

- decorative cover for boxes 3M
- screws are included
- in accordance with IEC 60670-1
- halogen free

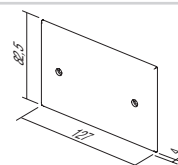

DM43

**KAPAK MBROJTËS PËR KUTI PM4**

- kapak mbrojtës për kuti PM4
- në përputhje me IEC 60670-1
- pa halogjenë
- mbrojtje për kuti gjatë suvatimit

*BOX COVER PROTECTIVE PM4*

- protective cover for box PM4
- in accordance with IEC 60670-1
- halogen free
- box protection during plastering

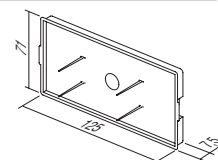

DM44

**KAPAK DEKORATIV PËR KUTI PM4**

- kapak dekorativ për kuti 4M
- vidat janë të përfshira
- në përputhje me IEC 60670-1
- pa halogjenë

*BOX COVER DECORATIVE PM4*

- decorative cover for boxes 4M
- screws are included
- in accordance with IEC 60670-1
- halogen free

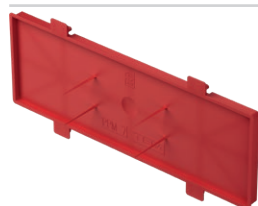
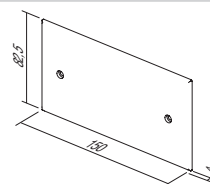

DM73

**KAPAK MBROJTËS PËR KUTI PM7**

- kapak mbrojtës për kuti PM7
- në përputhje me IEC 60670-1
- pa halogjenë
- mbrojtje për kuti gjatë suvatimit

*BOX COVER PROTECTIVE PM7*

- protective cover for box PM7
- in accordance with IEC 60670-1
- halogen free
- box protection during plastering

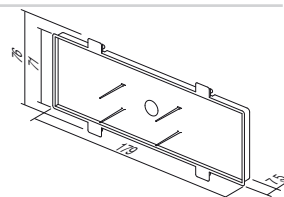

DM74

**KAPAK DEKORATIV PËR KUTI PM7**

- kapak dekorativ për kuti 7M
- vidat janë të përfshira
- në përputhje me IEC 60670-1
- pa halogjenë

*BOX COVER DECORATIVE PM7*

- decorative cover for boxes 7M
- screws are included
- in accordance with IEC 60670-1
- halogen free

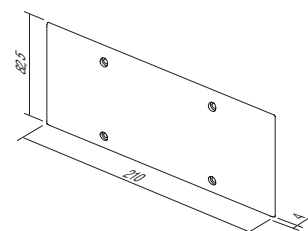



## R E C T A N G U L A R   B O X E S



DM75

## KAPAK DEKORATIV PËR KUTI PM72

- kapak dekorativ për kuti 2x7M
- vidat janë të përfshira
- në përputhje me IEC 60670-1

*BOX COVER DECORATIVE PM72*

- decorative cover for boxes 2x7M
- screws are included
- in accordance with IEC 60670-1

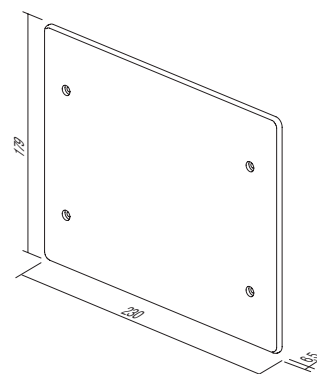

KUTI DREJTKËNDORE MUR BOSH VM3



HM30

- madhësia 3M, thellësia 49 mm
- vrima e prerjes 2xØ68/45mm
- 850°C, 400V~
- në përputhje me IEC 60670-1
- pa halogjenë

RECTANGULAR BOX HOLLOW WALL VM3

- size 3M, depth 49mm
- cutting hole 2xØ68/45mm
- 850°C, 400V~
- in accordance with IEC 60670-1
- halogen free

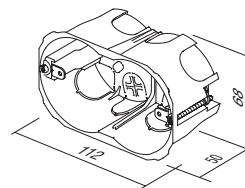

KUTI DREJTKËNDORE MUR BOSH VM4



HM40

- madhësia 4M, thellësia 49 mm
- vrima e prerjes 2xØ68/70mm
- 850°C, 400V~
- në përputhje me IEC 60670-1
- pa halogjenë

RECTANGULAR BOX HOLLOW WALL VM4

- size 4M, depth 49mm
- cutting hole 2xØ68/70mm
- 850°C, 400V~
- in accordance with IEC 60670-1
- halogen free

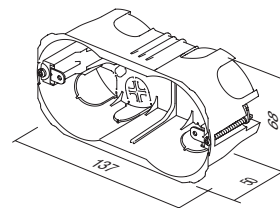

KUTI DREJTKËNDORE MUR BOSH VM7



HM70

- madhësia 7M, thellësia 49 mm
- vrima e prerjes 2xØ68/120mm
- 850°C, 400V~
- në përputhje me IEC 60670-1
- pa halogjenë

RECTANGULAR BOX HOLLOW WALL VM7

- size 7M, depth 49mm
- cutting hole 2xØ68/120mm
- 850°C, 400V~
- in accordance with IEC 60670-1
- halogen free

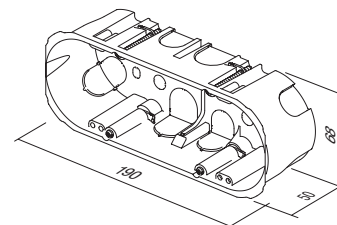

KUTI DREJTKËNDORE MUR BOSH VM72



HM72







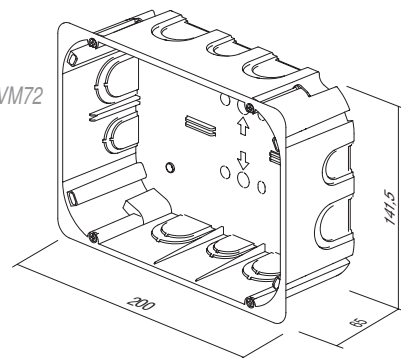

- madhësia 2x7M, thellësia 63mm
- 850°C, 400V~
- në përputhje me IEC 60670-1
- pa halogjenë

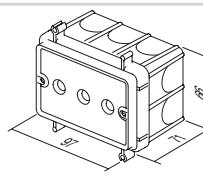
RECTANGULAR BOX HOLLOW WALL VM72

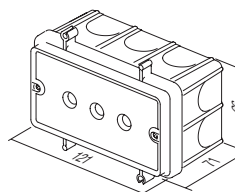
- size 2x7M, depth 63mm
- 850°C, 400V~
- in accordance with IEC 60670-1
- halogen free

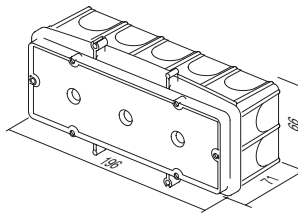

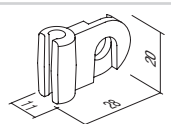
## R E C T A N G U L A R   B O X E S

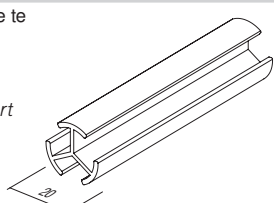
	BM30	<b>KUTI DREJTKËNDORE BETON BM3</b> - madhësia 3M, thellësia 60mm - 650°C, 400V~ - në përputhje me IEC 60670-1 - pa halogjenë <i>RECTANGULAR BOX CONCRETE BM3</i> - size 3M, depth 60mm - 650°C, 400V~ - in accordance with IEC 60670-1 - halogen free	
	BM40	<b>KUTI DREJTKËNDORE BETON BM4</b> - madhësia 4M, thellësia 60mm - 650°C, 400V~ - në përputhje me IEC 60670-1 - pa halogjenë <i>RECTANGULAR BOX CONCRETE BM4</i> - size 4M, depth 60mm - 650°C, 400V~ - in accordance with IEC 60670-1 - halogen free	
	BM70	<b>KUTI DREJTKËNDORE BETON BM7</b> - madhësia 7M, thellësia 60mm - 650°C, 400V~ - në përputhje me IEC 60670-1 - pa halogjenë <i>RECTANGULAR BOX CONCRETE BM7</i> - size 7M, depth 60mm - 650°C, 400V~ - in accordance with IEC 60670-1 - halogen free	
	BM80	<b>KAPËSE FIKSUESE E KOMBINUAR BM</b> - për fiksimin e shpejtë të kutive drejtkëndore BM në shufra përforcuese - i përshtatshëm për diametër shufre deri në Ø8mm <i>FIXING COMBI-CLIP BM</i> - for fast fixation of BM rectangular boxes on reinforcing bar - suitable for bar diameter up to Ø8mm	
	BM82	<b>PROFIL DISTANCUES PËR KUTITË PM</b> - për suportin e kutive BM me kundër-suport kutie te muri përballë - gjatësia l=1m, diametri Ø20mm <i>DISTANCE PROFIL FOR BOXES BM</i> - to support boxes BM with counter box support on opposite wall - length l=1m, diameter Ø20mm	

# K U T I T Ë D R E J T K Ë N D O R E



tullë / brick



mure bosh / hollow walls

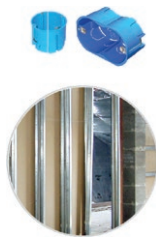

beton / concrete



DM30



NM30



HM30



BM30



3M

DM40



NM40



HM40



BM40



4M

DM70



NM70



HM70



BM70



7M

DM72



NM72

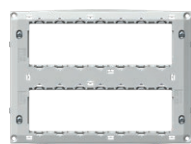

HM72



2x7M

DM30



NM32



HM30



BM30



2/3M

## R E C T A N G U L A R   B O X E S

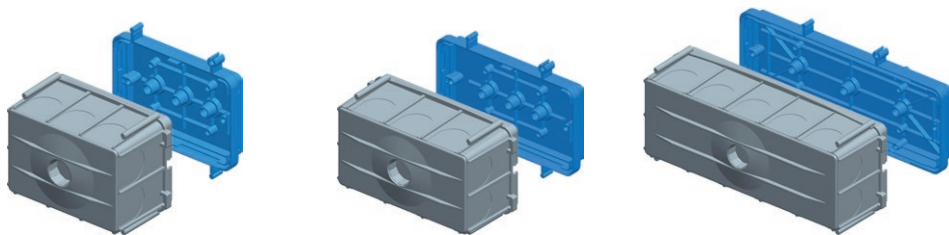

udhëzime për montimin /  
assembly instructions

1

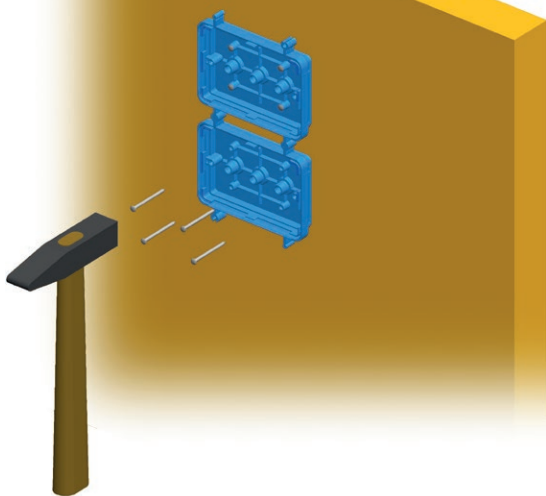

2

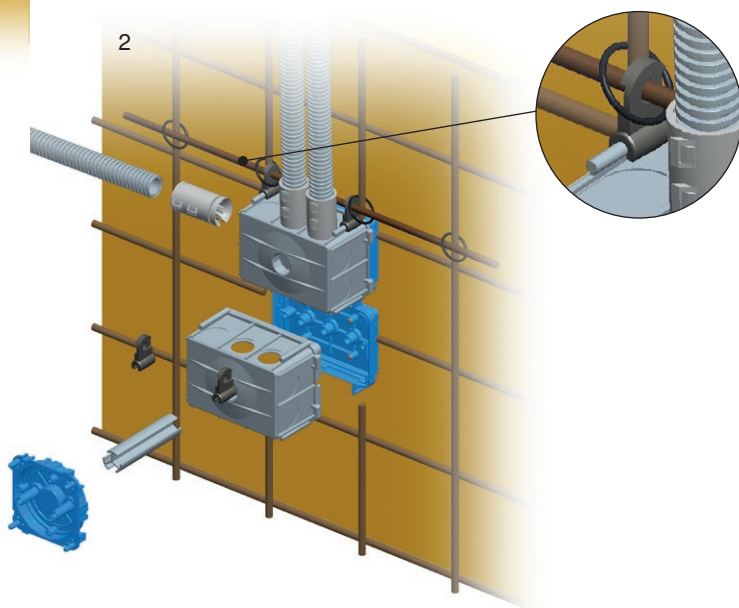

3

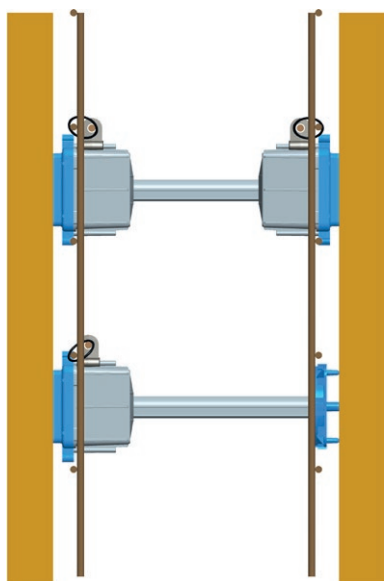

4

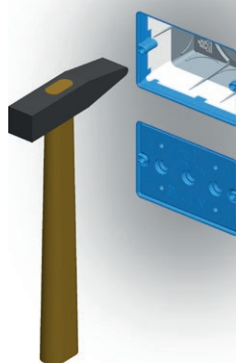

KUTI E RRUMBULLAKËT TULLË PËR LIDHJE DSM78



DW10

- Ø78, thellësia 40 mm
- 650°C, 500 V~
- në përputhje me IEC 60670-1 dhe IEC 60670-22
- pa halogjenë

CONNECTION ROUND BOX BRICK DSM78

- Ø78, depth 40mm
- 650°C, 500V~
- in accordance with IEC 60670-1 and IEC 60670-22
- halogen free

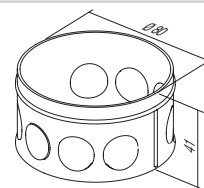

KUTI E RRUMBULLAKËT MUR BOSH SM78x45



HW10

- Ø78, thellësia 45mm
- vrima e prerjes Ø80
- 850°C, 400V~
- në përputhje me IEC 60670-1 dhe IEC 60670-22
- montim me kthetra
- pa halogjenë

CONNECTION ROUND BOX HOLLOW WALL SM78x45

- Ø78, depth 45mm
- cutting hole Ø80
- 850°C, 400V~
- in accordance with IEC 60670-1 and IEC 60670-22
- mounting with claws
- halogen free

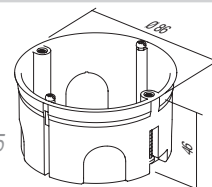

KAPAK DEKORATIV PËR KUTI SM78



DE23

- kapak dekorativ për kuti Ø78
- në përputhje me IEC 60670-1 dhe IEC 60670-22
- pa halogjenë

BOX COVER DECORATIVE SM78

- decorative cover for boxes Ø78
- in accordance with IEC 60670-1 and IEC 60670-22
- halogen free

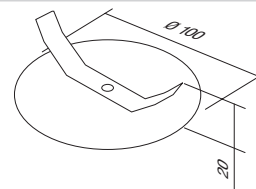

KAPAK MBROJTËS PËR KUTI 78



DE24

- kapak mbrojtës për kuti Ø78
- në përputhje me IEC 60670-1 dhe IEC 60670-22
- pa halogjenë

BOX COVER PROTECTIVE 78

- protective cover for box Ø78
- in accordance with IEC 60670-1 and IEC 60670-22
- halogen free

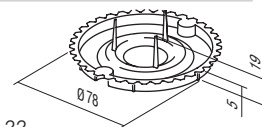

KUTI KATRORE TULLË PËR LIDHJE SM105x105



HW20

- madhësia 105X105 mm, thellësia 50 mm
- vrimë prerjeje sipas shabllonit bashkëngjitur
- 850°C, 400V~
- në përputhje me IEC 60670-1 dhe IEC 60670-22
- montim me kthetra
- pa halogjenë

CONNECTION SQUARE BOX BRICK SM105x105

- size 105x105mm, depth 50mm
- cutting hole according to attached template
- 850°C, 400V~
- in accordance with IEC 60670-1 and IEC 60670-22
- mounting with claws
- halogen free

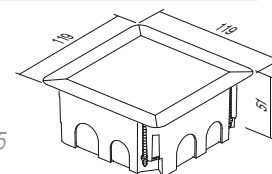



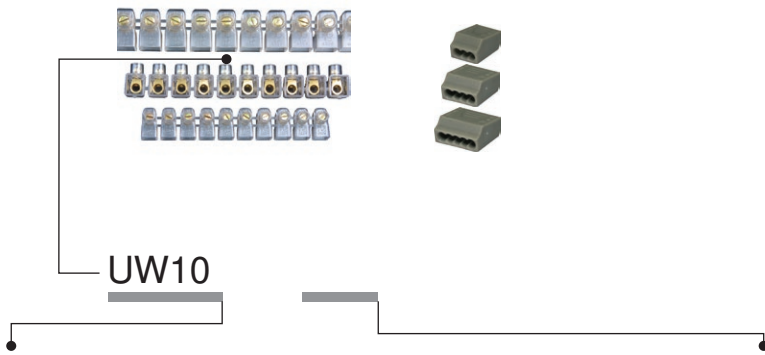

Iloji type	përshkrimi description	të dhënat teknike technical data	madhësia size	ngjyra colour
UW10	BLLOQE TERMINALESH ME 1 RADHË 1 ROW TERMINAL BLOCKS	2x2.5mm <sup>2</sup>	10P	<input checked="" type="checkbox"/> TS transparent transparent
UW11	BLLOQE TERMINALESH ME 1 RADHË 1 ROW TERMINAL BLOCKS	2x4mm <sup>2</sup>	10P	<input checked="" type="checkbox"/> CO ngjyra colour
UW12	BLLOQE TERMINALESH ME 1 RADHË 1 ROW TERMINAL BLOCKS	2x6mm <sup>2</sup>	10P	<input type="checkbox"/> WH e bardhë white
...	...	...	...	<input type="checkbox"/> GY gri grey

BLLOQE TERMINALESH ME 1 RADHË TË MBYLLURA



- 450 V~; 2x2,5 mm<sup>2</sup> ÷ 2x6mm<sup>2</sup>  
- termoplast PC, transparent  
- numri i poleve: 10

1 ROW TERMINAL BLOCKS CLOSED

- 450V~; 2x2,5mm<sup>2</sup> ÷ 2x6mm<sup>2</sup>  
- thermoplast PC, transparent  
- number of poles: 10

UW10TS	(NS12)	2x2.5mm <sup>2</sup>	10P
UW11TS	(NS12)	2x4mm <sup>2</sup>	10P
UW12TS	(NS12)	2x6mm <sup>2</sup>	10P

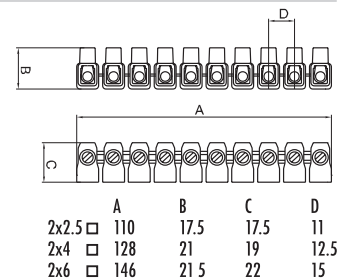

BLLOQE TERMINALESH ME 1 RADHË

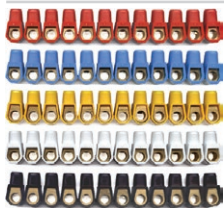

- 450 V~; 2x2,5 mm<sup>2</sup> ÷ 2x6mm<sup>2</sup>  
- termoplast PA  
- e disponueshme në ngjyra të ndryshme  
- numri i poleve: 12

1 ROW TERMINAL BLOCKS

- 450V~; 2x2,5mm<sup>2</sup> ÷ 2x6mm<sup>2</sup>  
- thermoplast PA  
- available in different colours  
- number of poles: 12

UW15CO	(NS12)	2x2.5mm <sup>2</sup>	12P
UW16CO	(NS12)	2x4mm <sup>2</sup>	12P
UW17CO	(NS12)	2x6mm <sup>2</sup>	12P

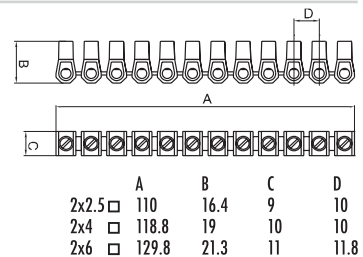

BLLOQE TERMINALESH ME 2 RADHË PP

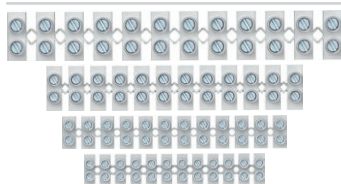

- 450 V~; 1 mm<sup>2</sup> ÷ 16 mm<sup>2</sup>  
- termoplast polipropilen PP, e bardhë  
- për temperaturat deri në 80°C  
- numri i poleve: 12

2 ROW TERMINAL BLOCKS PP

- 450V~; 1mm<sup>2</sup> ÷ 16mm<sup>2</sup>  
- thermoplast polypropylene PP, white  
- for temperatures up to 80°C  
- number of poles: 12

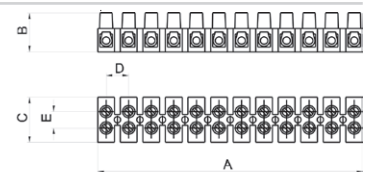

					A	B	C	D	E
UW29WHPP	1.0-4.0mm <sup>2</sup>	24 A	450 V		94,9	13	16,6	8,1	6,4
UW30WHPP	1.5-6.0mm <sup>2</sup>	32 A	450 V		116,5	14,9	18,9	10	7,3
UW31WHPP	2.5-10mm <sup>2</sup>	41 A	450 V		133,8	17,3	23,4	11,5	10
UW32WHPP	4-16mm <sup>2</sup>	76 A	450 V		174,5	20,7	25	15	11



## W I R I N G    A C C E S S O R I E S

## BLOQE TERMINALES ME 2 RADHË PA

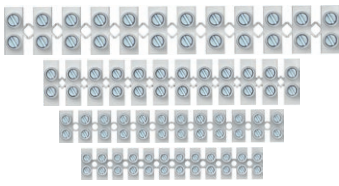

- 450 V~; 1 mm<sup>2</sup> ÷ 16 mm<sup>2</sup>
- termoplast poliamid PA, e bardhë
- për temperaturat deri në 110°C
- numri i poleve: 12

## 2 ROW TERMINAL BLOCKS PA

- 450V~; 1mm<sup>2</sup> ÷ 16mm<sup>2</sup>
- thermoplast polyamide PA, white
- for temperatures up to 110°C
- number of poles: 12

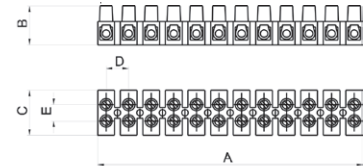

					A	B	C	D	E
UW25WHPA	1.0-4.0mm <sup>2</sup>	24 A	450 V		93,6	13,4	16,2	8	6,4
UW26WHPA	1.5-6.0mm <sup>2</sup>	32 A	450 V		117	15	18,6	10	7,3
UW27WHPA	2.5-10mm <sup>2</sup>	41 A	450 V		132,8	17,3	22,2	11,5	10
UW28WHPA	4-16mm <sup>2</sup>	76 A	450 V		173,9	20,8	25,2	15	11

## KONEKTORË PËR FUTJE TELASH



- 24 A 450 V~, termoplast PA, gri
- numri i poleve: 3÷8
- kontakte për futje telash 0,5÷1,5 mm<sup>2</sup>, për tela të fortë
- në përputhje me EN 60998-1

## PLUG-IN WIRE CONNECTORS

- 24A 450V~, thermoplast PA, grey
- number of poles: 3÷8
- plug-in contacts 0.5÷1.5mm<sup>2</sup>, for rigide wires
- in accordance with EN 60998-1

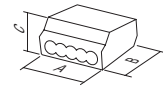

UW40GY	PC153	1.5mm <sup>2</sup>	3P	3P	A	B	C
UW41GY	PC155	1.5mm <sup>2</sup>	5P	5P	12	18	9
UW42GY	PC158	1.5mm <sup>2</sup>	8P	8P	17	18	9
					26	18	9

## KONEKTORË PËR FUTJE TELASH



- 24 A 450 V~, termoplast PA, gri
- numri i poleve: 3÷5
- kontakte për futje telash 1,5÷2,5mm<sup>2</sup>, për tela të fortë
- në përputhje me EN 60998-1

## PLUG-IN WIRE CONNECTORS

- 24A 450V~, thermoplast PA, grey
- number of poles: 3÷5
- plug-in contacts 1.5÷2.5mm<sup>2</sup>, for rigide wires
- in accordance with EN 60998-1

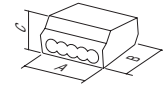

UW45GY	PC253	2.5mm <sup>2</sup>	3P	3P	A	B	C
UW46GY	PC254	2.5mm <sup>2</sup>	4P	4P	14	19	9
UW47GY	PC255	2.5mm <sup>2</sup>	5P	5P	17	19	9
					21	19	9

## KONEKTOR PËR FUTJE TELASH



- 24 A 450 V~, termoplast PA, gri
- numri i poleve: 2 (tel i fortë)+1 (tel i butë)
- kontakte për futje telash 1,5÷2,5mm<sup>2</sup>
- në përputhje me EN 60998-1

## PLUG-IN WIRE CONNECTOR

- 24A 450V~, thermoplast PA, grey
- number of poles: 2 (rigide wire)+1 (soft wire)
- plug-in contacts 1.5÷2.5mm<sup>2</sup>
- in accordance with EN 60998-1

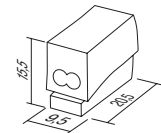

UW50WH	PC302	2.5mm <sup>2</sup>	2/P
--------	-------	--------------------	-----



MODUL  
PURE

132

133

135

140

# SHPËRNDARJA



**TEM**



# K U T I C U B O I P 2 0 A C

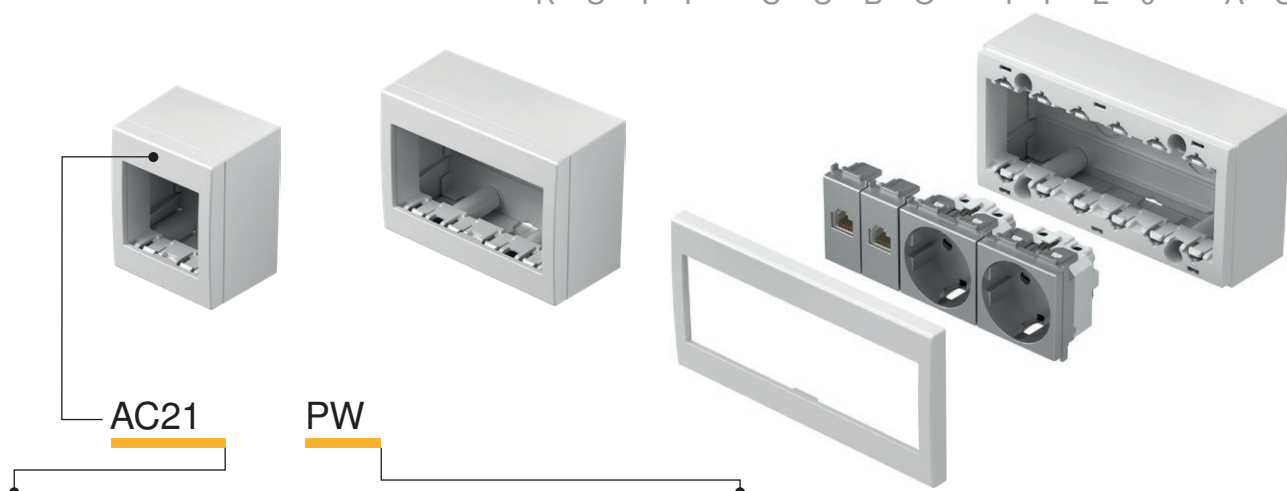

Iloji type	përshkrimi description	të dhënat teknike technical data	madhësia size	ngjyra colour
AC11	KUTI PËR MONTIM NË SIPËRFAQE NO CUBO ME KAPAK TË PASMË ANËSOR SURFACE MOUNT BOX WITH BACK SIDE COVER	IP20	1M	<input type="checkbox"/> PW e bardhë polare polar white <input type="checkbox"/> ES e argjendtë elox elox silver
AC21	KUTI PËR MONTIM NË SIPËRFAQE NO CUBO ME KAPAK TË PASMË ANËSOR SURFACE MOUNT BOX WITH BACK SIDE COVER	IP20	2M	<input type="checkbox"/> IW e bardhë fildishi ivory white
AC41	KUTI PËR MONTIM NË SIPËRFAQE NO CUBO ME KAPAK TË PASMË ANËSOR SURFACE MOUNT BOX WITH BACK SIDE COVER	IP20	4M	

## KUTI NO CUBO ME KAPAK TË PASMË ANËSOR IP20 1M



- AC11PW
- AC11ES
- AC11IW

- kuti IP20 1M
- për montimin në sipërfaqe të elementeve
- e përshtatshme për çelësat SM
- në përputhje me EN 60669-1

BOX NO CUBO WITH BACK SIDE COVER IP20 1M  
 - box IP20 1M  
 - for surface mounting of elements  
 - suitable to SM switches  
 - in accordance with EN 60669-1



## KUTI NO CUBO ME KAPAK TË PASMË ANËSOR IP20 2M



- AC21PW
- AC21ES
- AC21IW

- kuti IP20 2M
- për montimin në sipërfaqe të elementeve
- në përputhje me EN 60669-1, EN60884-1

BOX NO CUBO WITH BACK SIDE COVER IP20 2M  
 - box IP20 2M  
 - for surface mounting of elements  
 - in accordance with EN 60669-1, EN60884-1



## KUTI NO CUBO ME KAPAK TË PASMË ANËSOR IP20 4M



- AC41PW
- AC41ES
- AC41IW

- kuti IP20 4M
- për montimin në sipërfaqe të elementeve
- në përputhje me EN 60669-1, EN60884-1

BOX NO CUBO WITH BACK SIDE COVER IP20 4M  
 - box IP20 4M  
 - for surface mounting of elements  
 - in accordance with EN 60669-1, EN60884-1



## KUTI NO CUBO ME KAPAK TË PASMË ANËSOR IP20 6M



- AC61PW
- AC61ES
- AC61IW

- kuti IP20 6M
- për montimin në sipërfaqe të elementeve
- në përputhje me EN 60669-1, EN60884-1

BOX NO CUBO WITH BACK SIDE COVER IP20 6M  
 - box IP20 6M  
 - for surface mounting of elements  
 - in accordance with EN 60669-1, EN60884-1

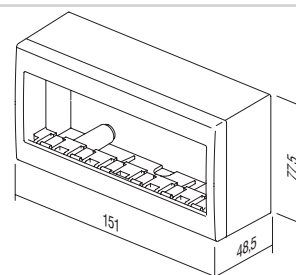
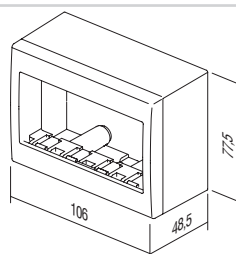
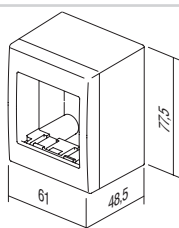
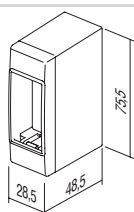

## B O X E S C U B O I P 5 5 A Q



lloji type	përshkrimi description	të dhënat teknike technical data	madhësia size	ngjyra colour
AQ20	KUTI ME MONTIM NË SIPËRFAQE TË JASHTME OUTDOOR SURFACE MOUNT BOX	IP55	2M	<input type="checkbox"/> PW e bardhë polare polar white
AQ22	KUTI ME MONTIM NË SIPËRFAQE TË JASHTME OUTDOOR SURFACE MOUNT BOX	IP55	2x2M	<input checked="" type="checkbox"/> GY gri grey
AQ30	KUTI ME MONTIM NË SIPËRFAQE TË JASHTME OUTDOOR SURFACE MOUNT BOX	IP55	3M	
AQ31	KUTI ME MONTIM NË SIPËRFAQE TË JASHTME OUTDOOR SURFACE MOUNT BOX	IP55	3M	

## KUTI NO CUBO IP55 2M



- AQ20PW
- AQ20GY

- kuti IP55 2M
- për montim në sipërfaqe
- IP55 për përdorim në zona me lagështirë
- në përputhje me CEI 23-48, EN 60670

## BOX NO CUBO IP55 2M

- box IP55 2M
- for surface mounting
- IP55 for usage in humid areas
- in accordance with CEI 23-48, EN 60670



## KUTI NO CUBO IP55 2x2M



- AQ22PW
- AQ22GY

- kuti IP55 2x2M
- për montim në sipërfaqe
- IP55 për përdorim në zona me lagështirë
- në përputhje me CEI 23-48, EN 60670

## BOX NO CUBO IP55 2x2M

- box IP55 2x2M
- for surface mounting
- IP55 for usage in humid areas
- in accordance with CEI 23-48, EN 60670



## KUTI NO CUBO IP55 3M



- AQ30PW
- AQ30GY

- kuti IP55 3M
- për montim në sipërfaqe
- IP55 për përdorim në zona me lagështirë
- në përputhje me CEI 23-48, EN 60670

## BOX NO CUBO IP55 3M

- box IP55 3M
- for surface mounting
- IP55 for usage in humid areas
- in accordance with CEI 23-48, EN 60670





- AQ21PW
- AQ21AT

**KUTI PO CUBO IP55 2M**

- kuti IP55 2M
- mund të kombinohet me të gjitha elementet funksionale të Modul
- për montim rrafsh
- IP55 për përdorim në zona me lagështirë
- në përputhje me CEI 23-48, EN 60670

**BOX PO CUBO IP55 2M**

- box IP55 2M
- can be combined with all Modul functional elements
- for flush mounting
- IP55 for usage in humid areas
- in accordance with CEI 23-48, EN 60670



- AQ31PW
- AQ31GY

**KUTI PO CUBO IP55 3M**

- kuti IP55 3M
- për montim rrafsh
- IP55 për përdorim në zona me lagështirë
- në përputhje me CEI 23-48, EN 60670

**BOX PO CUBO IP55 3M**

- box IP55 3M
- for flush mounting
- IP55 for usage in humid areas
- in accordance with CEI 23-48, EN 60670

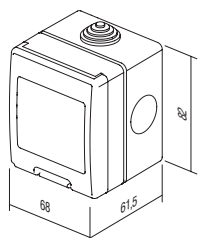

AQ20

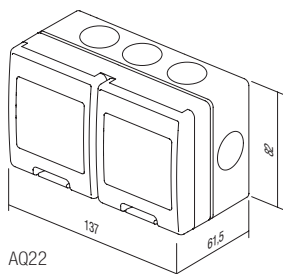

AQ22

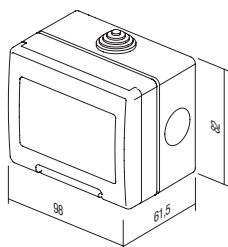

AQ30

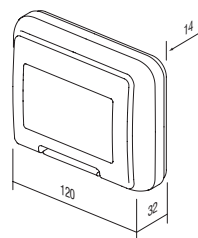

AQ31

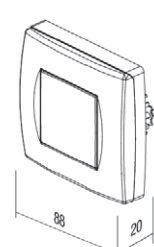

AQ21

## TRUNKING SYSTEM ALUMINIUM

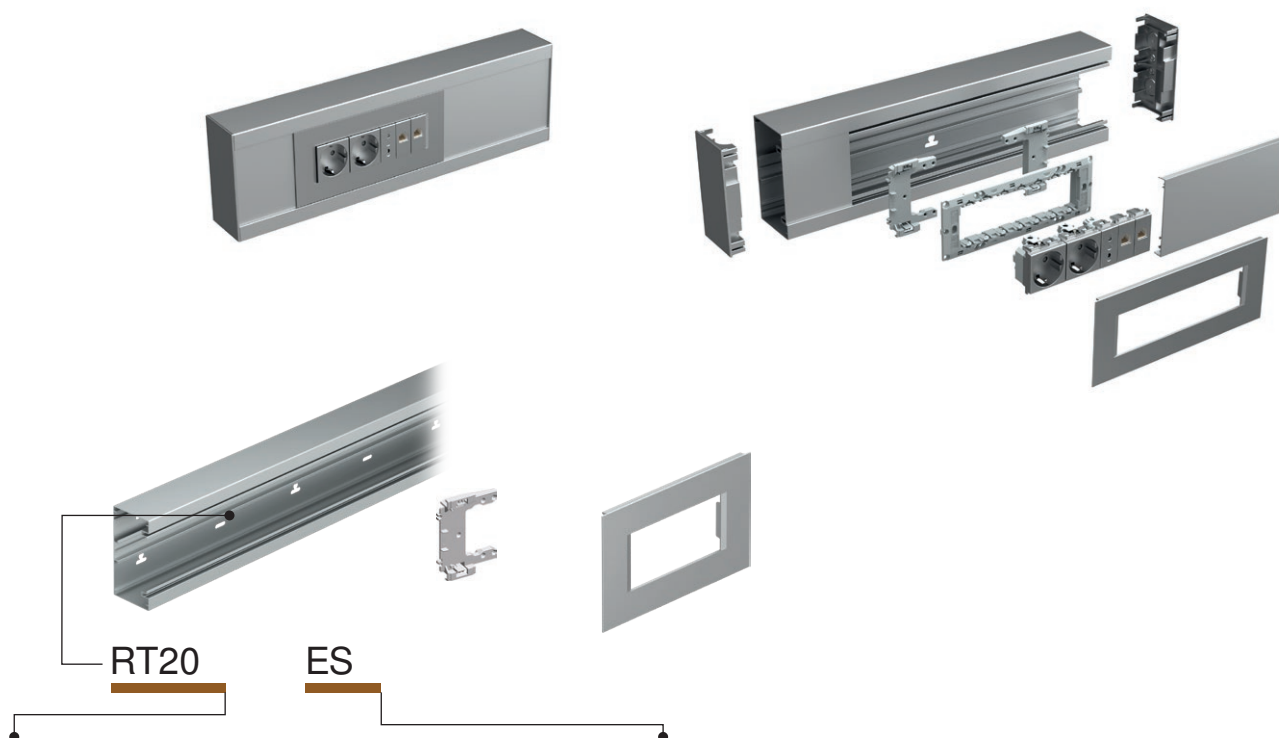

Iloji type	përshkrimi description	madhësia size	ngjyra colour
RT10	PËRSHTATËS MA 92 ADAPTER MA 92	/	■ ES e argjendtë elox elox silver-mat
RT12	KAPAK MBULUES MA 92 COVER PLATE MA 92	2/3M	□ PW e bardhë mat (RAL 9016) white-mat
RT14	KAPAK MBULUES MA 92 COVER PLATE MA 92	4M	
⋮	⋮	⋮	

## PËRSHTATËS MA 92



RT10

- përshtatës për fiksimin e kornizave të montimit 2/3M, 4M ose 7M në kanalina MA pa kuti
- secila kornizë montimi ka nevojë për dy përshtatës
- në përputhje me EN 50085-1

## ADAPTER MA 92

- adapter for fixing mounting frames 2/3M, 4M or 7M on MA trunking without box
- each mounting frame needs two adapters
- in accordance with EN 50085-1

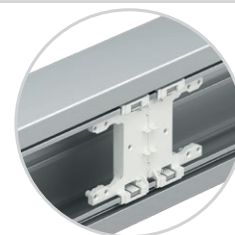

## KAPAK MBULUES MA 92 2/3M



■ RT12ES  
□ RT12PW

- kapak mbulues dekorativ MA 2/3M
- në përputhje me EN 50085-1

## COVER PLATE MA 92 2/3M

- decorative cover plate MA 2/3M
- in accordance with EN 50085-1

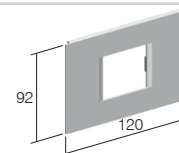

## KAPAK MBULUES MA 92 4M



■ RT14ES  
□ RT14PW

- kapak mbulues dekorativ MA 4M
- në përputhje me EN 50085-1

## COVER PLATE MA 92 4M

- decorative cover plate MA 4M
- in accordance with EN 50085-1

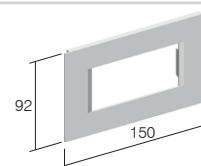

## KAPAK MBULUES MA 92 7M



■ RT17ES  
□ RT17PW

- kapak mbulues dekorativ MA 7M
- në përputhje me EN 50085-1

## COVER PLATE MA 92 7M

- decorative cover plate MA 7M
- in accordance with EN 50085-1

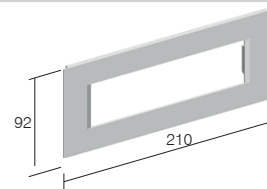

**BAZË PËR KANALINA MA 130x65**



- RT20ES
- RT20PW

- bazë për kanalina me profil alumini
- lartësia 130 mm, gjatësia 2 m
- DIN - formë shinë 35mm në fund
- në përputhje me EN 50085-1

**TRUNKING BASE MA 130x65**

- trunking base from extruded aluminium
- height 130mm, length 2m
- DIN - rail 35mm shape on bottom
- in accordance with EN 50085-1

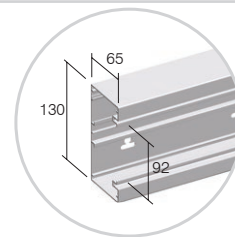

**BAZË PËR KANALINA MA 165x65**



- RT21ES
- RT21PW

- bazë për kanalina me profil alumini
- lartësia 165mm, gjatësia 2 m
- DIN - formë shinë 35mm në fund
- në përputhje me EN 50085-1

**TRUNKING BASE MA 165x65**

- trunking base from extruded aluminium
- height 165mm, length 2m
- DIN - rail 35mm shape on bottom
- in accordance with EN 50085-1

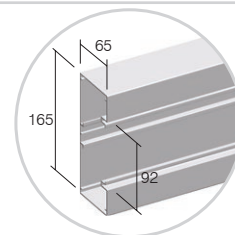

**KAPAK I PËRPARMË MA 92**



- RT25ES
- RT25PW

- kapak i përparmë prej profili alumini
- lartësia 92mm, gjatësia 2 m
- në përputhje me EN 50085-1

**FRONT COVER MA 92**

- front cover from extruded aluminium
- height 92mm, length 2m
- in accordance with EN 50085-1

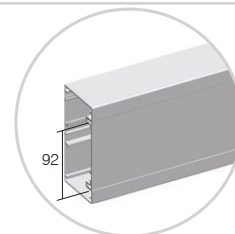

**RAFT KABLLOSH MA 43**



RT30

- raft kabllosh prej polimeresh
- thellësia 43mm, gjatësia 2 m
- në përputhje me EN 50085-1

**CABLE SHELF MA 43**

- cable shelf from extruded polymer
- depth 43mm, length 2m
- in accordance with EN 50085-1

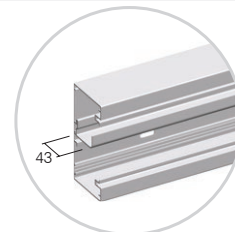

**RAFT KABLLOSH MA 43 AL**



RT31

- raft kabllosh prej profili alumini
- thellësia 43mm, gjatësia 2 m
- në përputhje me EN 50085-1

**CABLE SHELF MA 43 AL**

- cable shelf from extruded aluminium
- depth 43mm, length 2m
- in accordance with EN 50085-1

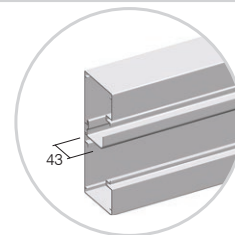

**RAFT KABLLOSH MA 43 AL DYSH**



RT32

- raft i dyfishtë kabllosh prej profili alumini
- thellësia 43mm, gjatësia 2 m
- në përputhje me EN 50085-1

**CABLE SHELF MA 43 AL DOUBLE**

- double cable shelf from extruded aluminium
- depth 43mm, length 2m
- in accordance with EN 50085-1

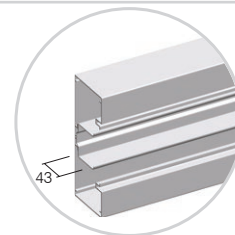



## T R U N K I N G   S Y S T E M   A L U M I N I U M

## ELEMENT FUNDOR BLOKUES MA 130x65



- RT35ES
- RT35PW

- element fundor bllokues prej polimeri
- lartësia 130mm
- në përputhje me EN 50085-1

*STOP END MA 130x65*

- stop end element from polymer
- height 130mm
- in accordance with EN 50085-1

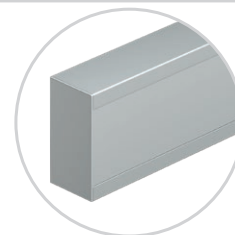

## ELEMENT FUNDOR BLOKUES MA 165x65



- RT36ES
- RT36PW

- element fundor bllokues prej metali
- lartësia 165mm
- në përputhje me EN 50085-1

*STOP END MA 165x65*

- stop end element from metal
- height 165mm
- in accordance with EN 50085-1

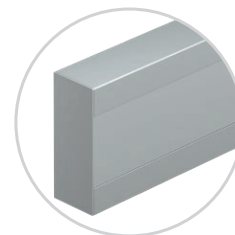

## SET PJESË BASHKUESE MA 65



RT38

- pjesë bashkuese prej polimeri
- seti përmban dy pjesë dhe vida
- në përputhje me EN 50085-1

*SET JOINING PIECE MA 65*

- joining piece from polymer
- set contains two pieces and screws
- in accordance with EN 50085-1

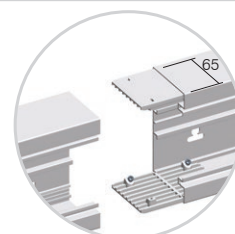

## KËND UNIVERSAL MA 130x65



- RT40ES
- RT40PW

- element këndor universal
- lartësia 130mm
- në përputhje me EN 50085-1

*UNIVERSAL CORNER MA 130x65*

- universal corner element
- height 130mm
- in accordance with EN 50085-1



## KËND UNIVERSAL MA 165x65



- RT41ES
- RT41PW

- element këndor universal
- lartësia 165mm
- në përputhje me EN 50085-1

*UNIVERSAL CORNER MA 165x65*

- universal corner element
- height 165mm
- in accordance with EN 50085-1

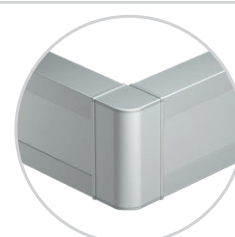

## PJESË TOKËZIMI MA 2x A6.3



RT42

- pjesë tokëzimi për tokëzimin e bazës së kanalit dhe kapakut të përparmë
- në përputhje me EN 50085-1

*EARTHING PIECE MA 2x A6.3*

- earthing piece for earthing of trunking base and front cover
- in accordance with EN 50085-1

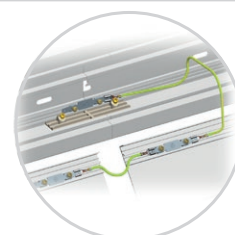

**BËRRYL L MA 130x65**



- RT43ES
- RT43PW

- bërryl universal L prej alumini
- lartësia 130 mm, gjatësia 400mm
- në përputhje me EN 50085-1

**L-BEND MA 130x65**

- universal L bend element from aluminium
- height 130mm, length 400mm
- in accordance with EN 50085-1

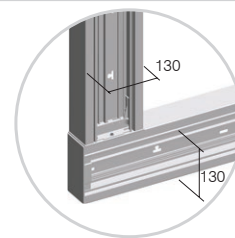

**BËRRYL L MA 165x65**



- RT44ES
- RT44PW

- bërryl universal L prej alumini
- lartësia 165mm, gjatësia 400mm
- lidhje në MA 130x65
- në përputhje me EN 50085-1

**L-BEND MA 165x65**

- universal L bend element from aluminium
- height 165mm, length 400mm
- connection on MA 130x65
- in accordance with EN 50085-1

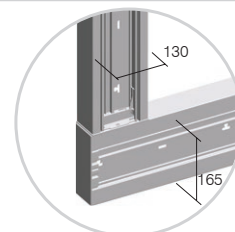

**BËRRYL T MA 130x65**



- RT45ES
- RT45PW

- bërryl universal T prej alumini
- lartësia 130 mm, gjatësia 400mm
- në përputhje me EN 50085-1

**T-BEND MA 130x65**

- universal T bend element from aluminium
- height 130mm, length 400mm
- in accordance with EN 50085-1

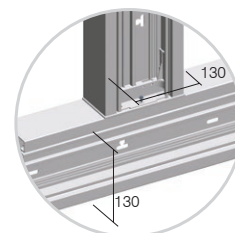

**BËRRYL T MA 165x65**

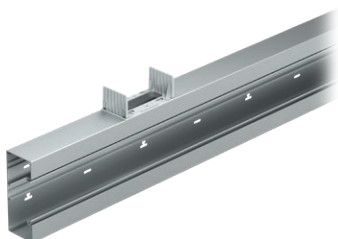

- RT46ES
- RT46PW

- bërryl universal T prej alumini
- lartësia 165mm, gjatësia 400mm
- lidhje në MA 130x65
- në përputhje me EN 50085-1

**T-BEND MA 165x65**

- universal T bend element from aluminium
- height 165mm, length 400mm
- connection on MA 130x65
- in accordance with EN 50085-1

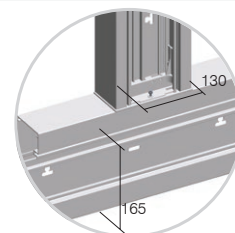

Kanalina MA bazohet në sistem modular dhe krijon kombinime elementesh 2M, 4M ose 7M

MA trunking is based on modular system making 2M, 4M or 7M combinations of elements

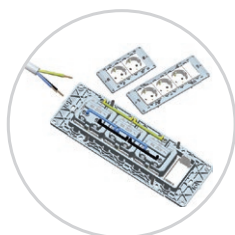

Në Modul ne ofrojmë elemente speciale për instalim të shpejtë

In Modul we provide special elements for quick installation

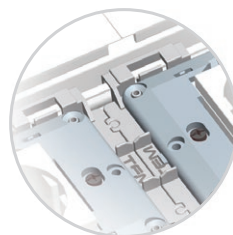

Me Përshtatësin MA ofrohet pozicionimi ekzakt pa përpjekje shtesë

With Adapter MA exact positioning without extra effort is provided

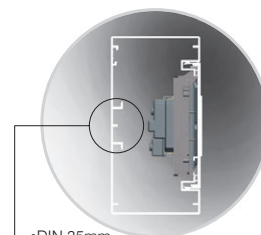

Montimi pa kuti nënkupton më shumë hapësirë për kablot, forma e bazës me shinë DIN EN-60715

Mounted without box means more space for cables, DIN-rail base shape EN-60715

# T R U N K I N G   S Y S T E M   A L U M I N I U M



## PLLAKËZ FIKSUESE MA NJËSHE 130x65



- RT50ES
- RT50PW

- pllakë fiksuese për fiksimin e bazës së kanalitës MA130 në dysheme dhe/ose në tavan  
- në përputhje me EN 50085-1

### FIXING PLATE MA SINGLE 130x65

- fixing plate for fixing trunking base MA130 on the floor and/or on the ceiling  
- in accordance with EN 50085-1



- RT51ES
- RT51PW

## PLLAKËZ FIKSUESE MA DYSHE 130x65

- pllakëz fiksuese për fiksimin e dy bazave të kanalitës MA130 në dysheme dhe/ose në tavan  
- në përputhje me EN 50085-1

### FIXING PLATE MA DOUBLE 130x65

- fixing plate for fixing two trunking bases MA130 on the floor and/or on the ceiling  
- in accordance with EN 50085-1



- RT52ES
- RT52PW

## KABINË SHËRBIMI MA 130x65x500

- kabinetë shërbimi MA  
- lartësia 500mm  
- kornizë montimi 7M e përfshirë  
- në përputhje me EN 50085-1

### SERVICE POST MA 130x65x500

- service post MA  
- height 500mm  
- mounting frame 7M included  
- in accordance with EN 50085-1

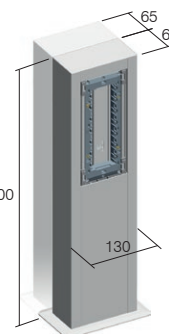

## KABINË SHËRBIMI MA DYSHE 130x130x500

- RT53ES
- RT53PW

- kabinetë shërbimi MA dyshe  
- lartësia 500mm  
- korniza montimi 7M të përfshira  
- në përputhje me EN 50085-1

### SERVICE POST MA DOUBLE 130x130x500

- service post MA double  
- height 500mm  
- mounting frames 7M included  
- in accordance with EN 50085-1

Ndërthurja e kablos / Cable intersection mm <sup>2</sup>	Prerje e tërthortë e kablos / Cable cross-section (mm <sup>2</sup> )				
	1 tel / 1 wire	2 tela / 2 wires	3 tela / 3 wires	4 tela / 4 wires	5 tela / 5 wires
1,5	44	111	121	144	169
2,5	49	133	157	169	211
4	58	169	183	211	256
6	68	196	225	256	307

Kanalina / Trunk	Kapaciteti i kanalitës / Trunk capacity			
	MA 130x65 bosh / empty	MA 130x65 me çelësat dhe prizat Modul / with Modul switches and sockets	MA 165x65 bosh / empty	MA 130x65 me çelësat dhe prizat Modul / with Modul switches and sockets
kapaciteti capacity	7600 mm <sup>2</sup>	5500 mm <sup>2</sup>	9900 mm <sup>2</sup>	7800 mm <sup>2</sup>
max ø	54 mm	2x42 mm	54 mm	2x42 mm

# K U T I D Y S H E M E J E M T

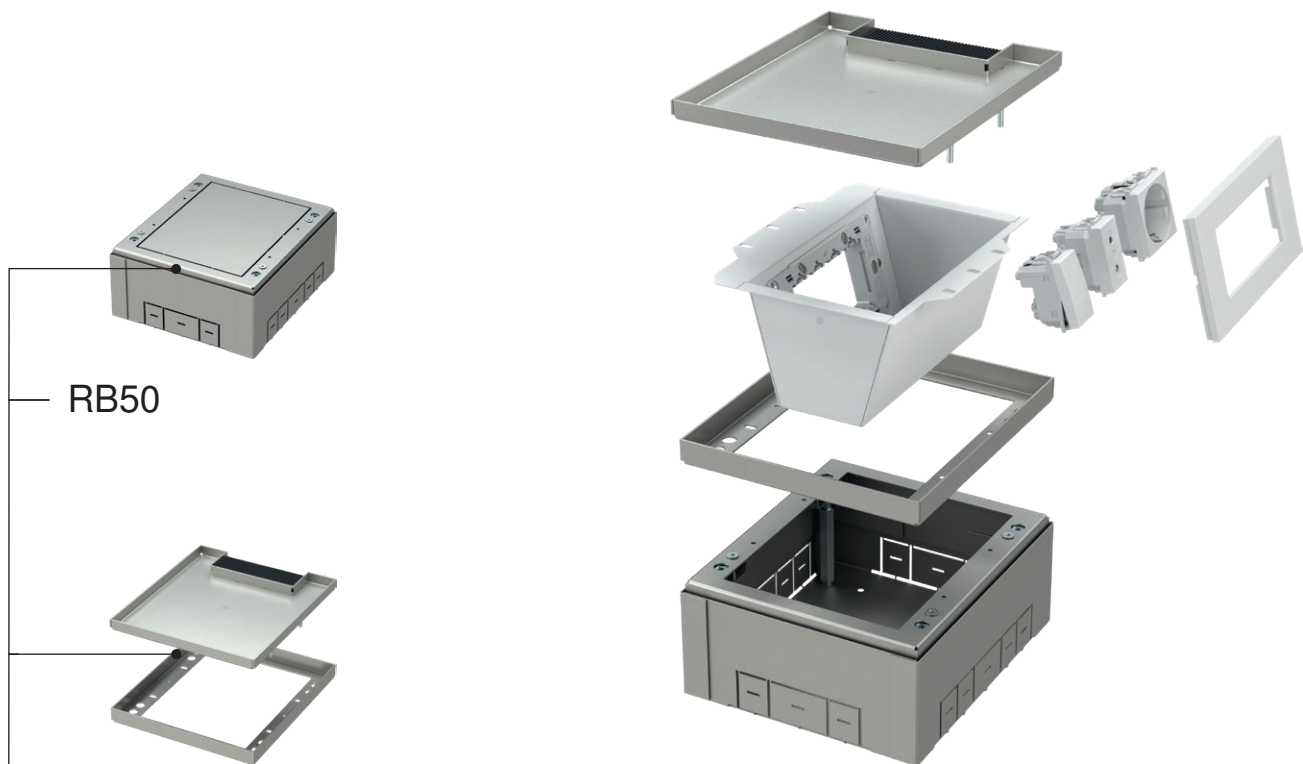

RB50

RB65S1

Iloji type	përshkrimi description	të dhënat teknike technical data
RB50	BAZË KUTIE DYSHEMEJE FLOOR BOX BASE	4M
RB65S1	INSERT PËR KUTI SHPËRNDARJEJE PËR DYSHEME FLOOR DISTRIBUTION BOX COVER	4M
RB60	INSERT PËR KUTI SHPËRNDARJEJE PËR DYSHEME INSERT FOR FLOOR DISTRIBUTION BOX	4M
·	·	·
·	·	·

	RB65S1	RB66S1	RB67S2	RB68S2
X	177	178	265	516,5
Y	200,5	265	265	265
Z	17,5	17,5	17,5	17,5

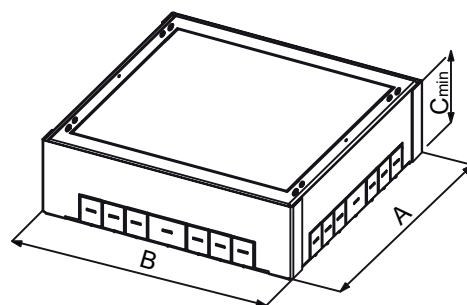
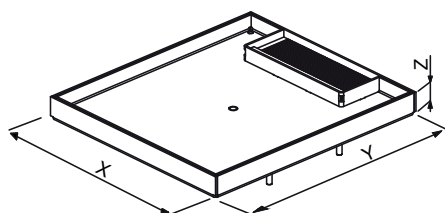

	RB50	RB51	RB52	RB53
A	208,5	273	273	273
B	182	182,5	269,5	521
C	83	83	83	83

## F L O O R   B O X E S   M T

## BAZË KUTIE DYSHEMEJE 4M



RB50

- bazë kutie dysHEMEJE 4M
- metalike, e galvanizuar
- për instalim në një dysHEME ose dysHEME dysHE
- dimensionet e montimit 208,5x182 mm, thellësia min. 83 mm
- lartësia e rregullueshme 83-128 mm
- në përputhje me standardet EN 5005-1 në EN 50085-2-2

*FLOOR BOX BASE 4M*

- floor box base 4M
- metal, galvanized
- for installation in a floor or double floor
- mounting dimensions 208.5x182mm, min. depth 83mm
- adjustable height 83-128mm
- In accordance with EN 5005-1 and EN 50085-2-2

## INSERT PËR KUTI SHPËRNDARJEJE PËR DYSHEME 4M



RB60

- insert për kuti shpërndarjeje 4M
- metalik, ngjyrë e bardhë RAL 9006
- korniza e montimit MODUL 4M e përfshirë
- në përputhje me standardet EN 5005-1 në EN 50085-2-2

*INSERT FOR FLOOR DISTRIBUTION BOX 4M*

- insert for floor box 4M
- metal, colour white RAL 9006
- mounting frame MODUL 4M included
- in accordance with EN 5005-1 and EN 50085-2-2

## KAPAK PËR KUTI SHPËRNDARJEJE PËR DYSHEME 4M



RB65S1

- kapak për kuti dysHEMEJE 4M
- metalik, i galvanizuar
- dimensionet e montimit 200,5x177 mm, thellësia 17,5 mm
- trashësia e dysHEMESË deri në 11,5 mm
- në përputhje me standardet EN 5005-1 në EN 50085-2-2

*FLOOR DISTRIBUTION BOX COVER 4M*

- floor box cover 4M
- metal, galvanized
- mounting dimensions 200.5x177mm, depth 17.5mm
- floor thickness up to 11.5mm
- in accordance with EN 5005-1 and EN 50085-2-2

## BAZË KUTIE DYSHEMEJE 7M



RB51

- bazë kutie dysHEMEJE 7M
- metalike, e galvanizuar
- për instalim në një dysHEME ose dysHEME dysHE
- dimensionet e montimit 273x182,5 mm, thellësia min. 83 mm
- lartësia e rregullueshme 83-128 mm
- në përputhje me standardet EN 5005-1 në EN 50085-2-2

*FLOOR BOX BASE 7M*

- floor box base 7M
- metal, galvanized
- for installation in a floor or double floor
- mounting dimensions 273x182.5mm, min. depth 83mm
- adjustable height 83-128mm
- in accordance with EN 5005-1 and EN 50085-2-2

## INSERT PËR KUTI SHPËRNDARJEJE PËR DYSHEME 7M



RB61

- insert për kuti dysHEMEJE 7M
- metalik, ngjyrë e bardhë RAL 9006
- korniza e montimit MODUL 7M e përfshirë
- në përputhje me standardet EN 5005-1 në EN 50085-2-2

*INSERT FOR FLOOR DISTRIBUTION BOX 7M*

- insert for floor box 7M
- metal, colour white RAL 9006
- mounting frame MODUL 7M included
- in accordance with EN 5005-1 and EN 50085-2-2

## KAPAK PËR KUTI SHPËRNDARJEJE PËR DYSHEME 7M

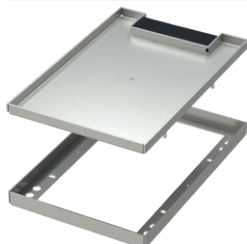

RB66S1

- kapak për kuti dysHEMEJE 7M
- metalik, i galvanizuar
- dimensionet e montimit 265x178 mm, thellësia 17,5 mm
- trashësia e dysHEMESË deri në 11,5 mm
- në përputhje me standardet EN 5005-1 në EN 50085-2-2

*FLOOR DISTRIBUTION BOX COVER 7M*

- floor box cover 7M
- metal, galvanized
- mounting dimensions 265x178mm, depth 17.5mm
- floor thickness up to 11.5mm
- in accordance with EN 5005-1 and EN 50085-2-2



RB52

**BAZË KUTIE DYSHEMEJE 2X7M**

- bazë kutie dyshemeje 2X7M
- metalike, e galvanizuar
- për instalim në një dysheme ose dysheme dyshe
- dimensionet e montimit 273x269,5 mm, thellësia min. 83 mm
- lartësia e rregullueshme 83-128 mm
- në përputhje me standardet EN 5005-1 në EN 50085-2-2

**FLOOR BOX BASE 2X7M**

- floor box base 2X7M
- metal, galvanized
- for installation in a floor or double floor
- mounting dimensions 273x269.5mm, min. depth 83mm
- adjustable height 83-128mm
- in accordance with EN 5005-1 and EN 50085-2-2



RB62

**INSERT PËR KUTI SHPËRNDARJEJE PËR DYSHEME 2X7M**

- insert për kuti dyshemeje 2x7M
- metalik, ngjyrë e bardhë RAL 9006
- kornizat e montimit MODUL 2x7M të përfshira
- në përputhje me standardet EN 5005-1 në EN 50085-2-2

**INSERT FOR FLOOR DISTRIBUTION BOX 2X7M**

- insert for floor box 2x7M
- metal, colour white RAL 9006
- mounting frames MODUL 2x7M included
- in accordance with EN 5005-1 and EN 50085-2-2



RB67S2

**KAPAK PËR KUTI SHPËRNDARJEJE PËR DYSHEME 2X7M**

- kapak për kuti dyshemeje 2x7M
- metalik, i galvanizuar
- dimensionet e montimit 265x265 mm, thellësia 17,5 mm
- trashësia e dyshemesë deri në 11,5 mm
- në përputhje me standardet EN 5005-1 në EN 50085-2-2

**FLOOR DISTRIBUTION BOX COVER 2X7M**

- floor box cover 2x7M
- metal, galvanized
- mounting dimensions 265x265mm, depth 17.5mm
- floor thickness up to 11.5mm
- in accordance with EN 5005-1 and EN 50085-2-2

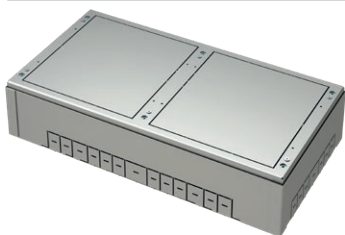

RB53

**BAZË KUTIE DYSHEMEJE 4X7M**

- bazë kutie dyshemeje 4X7M
- metalike, e galvanizuar
- për instalim në një dysheme ose dysheme dyshe
- dimensionet e montimit 273x521 mm, thellësia min. 83 mm
- lartësia e rregullueshme 83-128 mm
- në përputhje me standardet EN 5005-1 në EN 50085-2-2

**FLOOR BOX BASE 4X7M**

- floor box base 4X7M
- metal, galvanized
- for installation in a floor or double floor
- mounting dimensions 273x521mm, min. depth 83mm
- adjustable height 83-128mm
- in accordance with EN 5005-1 and EN 50085-2-2



RB62

**INSERT PËR KUTI SHPËRNDARJEJE PËR DYSHEME 2X7M**

- insert për kuti dyshemeje 2x7M
- metalik, ngjyrë e bardhë RAL 9006
- kornizat e montimit MODUL 2x7M të përfshira
- në përputhje me standardet EN 5005-1 në EN 50085-2-2

**INSERT FOR FLOOR DISTRIBUTION BOX 2X7M**

- insert for floor box 2x7M
- metal, colour white RAL 9006
- mounting frames MODUL 2x7M included
- in accordance with EN 5005-1 and EN 50085-2-2



RB68S2

**KAPAK PËR KUTI SHPËRNDARJEJE PËR DYSHEME 4X7M**

- kapak për kuti dyshemeje 4x7M
- metalik, i galvanizuar
- dimensionet e montimit 265x516,5 mm, thellësia 17,5 mm
- trashësia e dyshemesë deri në 11,5 mm
- në përputhje me standardet EN 5005-1 në EN 50085-2-2

**FLOOR DISTRIBUTION BOX COVER 4X7M**

- floor box cover 4x7M
- metal, galvanized
- mounting dimensions 265x516.5mm, depth 17.5mm
- floor thickness up to 11.5mm
- in accordance with EN 5005-1 and EN 50085-2-2



RB55S1

Iloji type	përshkrimi description	të dhënat teknike technical data
RB55S1	KUTI DYSHEMEJE ME KAPAK PËR DYSHEME DYSHE FLOOR BOX WITH COVER FOR DOUBLE FLOORS	4M
RB60	INSERT PËR KUTI SHPËRNDARJEJE PËR DYSHEME INSERT FOR FLOOR DISTIRBUTION BOX	4M
⋮	⋮	⋮

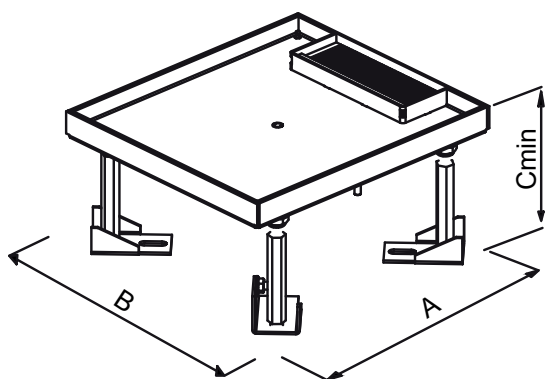

	RB55S1	RB56S1	RB57S2	RB58S2
A	200,5	265	265	265
B	177	178	265	516,5
C	100	100	100	100

## KUTI DYSHEMEJE ME KAPAK PËR DYSHEME DYSHE 4M



RB55S1

- bazë kutie dyshemeje 4M
- metalike, e galvanizuar
- dimensionet e montimit 200,5x177 mm, thellësia min. 100 mm
- lartësia e rregullueshme 100-145 mm
- trashësia e dyshemesë deri në 11,5 mm
- në përputhje me standardet EN 5005-1 në EN 50085-2-2

## FLOOR BOX WITH COVER FOR DOUBLE FLOORS 4M

- floor box base 4M
- metal, galvanized
- mounting dimensions 200.5x177mm, min. depth 100mm
- adjustable height 100-145mm
- floor thickness up to 11.5mm
- in accordance with EN 5005-1 and EN 50085-2-2

## INSERT PËR KUTI SHPËRNDARJEJE PËR DYSHEME 4M



RB60

- insert për kuti shpërndarjeje 4M
- metalik, ngjyrë e bardhë RAL 9006
- korniza e montimit MODUL 4M e përfshirë
- në përputhje me standardet EN 5005-1 në EN 50085-2-2

## INSERT FOR FLOOR DISTIRBUTION BOX 4M

- insert for floor box 4M
- metal, colour white RAL 9006
- mounting frame MODUL 4M included
- in accordance with EN 5005-1 and EN 50085-2-2

KUTI DYSHEMEJE ME KAPAK PËR DYSHEME DYSHE 7M



RB56S1

- bazë kutie dyshemeje 7M
- metalike, e galvanizuar
- dimensionet e montimit 265x178 mm, thellësia min. 100 mm
- lartësia e rregullueshme 100-145 mm
- trashësia e dyshemesë deri në 11.5 mm
- në përputhje me standardet EN 5005-1 në EN 50085-2-2

*FLOOR BOX WITH COVER FOR DOUBLE FLOORS 7M*

- floor box base 7M
- metal, galvanized
- mounting dimensions 265x178mm, min. depth 100mm
- adjustable height 100-145mm
- floor thickness up to 11.5mm
- in accordance with EN 5005-1 and EN 50085-2-2

INSERT PËR KUTI SHPËRNDARJEJE PËR DYSHEME 7M



RB61

- insert për kuti dyshemeje 7M
- metalik, ngjyrë e bardhë RAL 9006
- korniza e montimit MODUL 7M e përfshirë
- në përputhje me standardet EN 5005-1 në EN 50085-2-2

*INSERT FOR FLOOR DISTRIBUTION BOX 7M*

- insert for floor box 7M
- metal, colour white RAL 9006
- mounting frame MODUL 7M included
- in accordance with EN 5005-1 and EN 50085-2-2

KUTI DYSHEMEJE ME KAPAK PËR DYSHEME DYSHE 2X7M



RB57S2

- bazë kutie dyshemeje 2x7M
- metalike, e galvanizuar
- dimensionet e montimit 265x265 mm, thellësia min. 100 mm
- lartësia e rregullueshme 100-145 mm
- trashësia e dyshemesë deri në 11.5 mm
- në përputhje me standardet EN 5005-1 në EN 50085-2-2

*FLOOR BOX WITH COVER FOR DOUBLE FLOORS 2X7M*

- floor box base 2x7M
- metal, galvanized
- mounting dimensions 265x265mm, min. depth 100mm
- adjustable height 100-145mm
- floor thickness up to 11.5mm
- in accordance with EN 5005-1 and EN 50085-2-2

INSERT PËR KUTI SHPËRNDARJEJE PËR DYSHEME 2X7M



RB62

- insert për kuti dyshemeje 2x7M
- metalik, ngjyrë e bardhë RAL 9006
- kornizat e montimit MODUL 2x7M të përfshira
- në përputhje me standardet EN 5005-1 në EN 50085-2-2

*INSERT FOR FLOOR DISTRIBUTION BOX 2X7M*

- insert for floor box 2x7M
- metal, colour white RAL 9006
- mounting frames MODUL 2x7M included
- in accordance with EN 5005-1 and EN 50085-2-2

KUTI DYSHEMEJE ME KAPAK PËR DYSHEME DYSHE 4X7M



RB58S2

- bazë kutie dyshemeje 4x7M
- metalike, e galvanizuar
- dimensionet e montimit 265x516.5 mm, thellësia min. 100 mm
- lartësia e rregullueshme 100-145 mm
- trashësia e dyshemesë deri në 11.5 mm
- në përputhje me standardet EN 5005-1 në EN 50085-2-2

*FLOOR BOX WITH COVER FOR DOUBLE FLOORS 4X7M*

- floor box base 4x7M
- metal, galvanized
- mounting dimensions 265x516.5mm, min. depth 100mm
- adjustable height 100-145mm
- floor thickness up to 11.5mm
- in accordance with EN 5005-1 and EN 50085-2-2

INSERT PËR KUTI SHPËRNDARJEJE PËR DYSHEME 2X7M

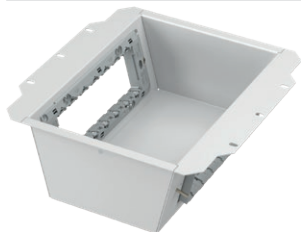

RB62

- insert për kuti dyshemeje 2x7M
- metalik, ngjyrë e bardhë RAL 9006
- kornizat e montimit MODUL 2x7M të përfshira
- në përputhje me standardet EN 5005-1 në EN 50085-2-2

*INSERT FOR FLOOR DISTRIBUTION BOX 2X7M*

- insert for floor box 2x7M
- metal, colour white RAL 9006
- mounting frames MODUL 2x7M included
- in accordance with EN 5005-1 and EN 50085-2-2

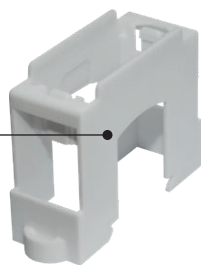
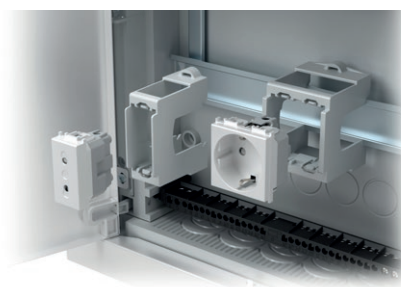

**RB10**

Iloji type	përshkrimi description	të dhënat teknike technical data
RB10	PËRSHTATËS PËR SHINË DIN ADAPTER FOR DIN RAIL	35mm 1M
RB11	PËRSHTATËS PËR SHINË DIN ADAPTER FOR DIN RAIL	35mm 2M
·	KUTI SHPËRNDARJEJE	·
·	·	·
·	·	·

**PËRSHTATËS PËR SHINË DIN 35 mm 1M**

**RB10**

- përshtatës MODUL 1M
- për shinë DIN 35 mm
- në përputhje me EN 50022

**ADAPTER FOR DIN RAIL 35mm 1M**

- adapter MODUL 1M
- for DIN rail 35mm
- in accordance with EN 50022

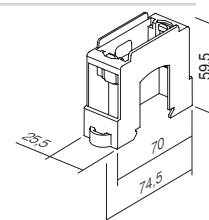

**PËRSHTATËS PËR SHINË DIN 35 mm 2M**

**RB11**

- përshtatës MODUL 2M
- për shinë DIN 35 mm
- në përputhje me EN 50022

**ADAPTER FOR DIN RAIL 35mm 2M**

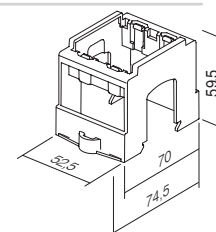
- adapter MODUL 2M
- for DIN rail 35mm
- in accordance with EN 50022



SWITCH  
LOGIQ



**TEM**

# LOGIQ

## **VETËBESIM I PRANISHËM KUDO** **krijuar për çdo dhomë**

Një formë për çdo dhomë. Çelësat kanë linja universale që lënë shenjë si në ambiente moderne pune ashtu edhe në hapësira të rehatshme ndenjeje. Familja LOGIQ ofron një zgjidhje të thjeshtë dhe logjike për çdo dëshirë tuajën.

## **OMNIPRESENT CONFIDENCE** **made for every room**

A shape for every room. The switches have universal lines that leave a mark in both modern work environments as well as in cosy, comfortable living spaces. The LOGIQ family offers a simple and logical solution for your every wish.



# LOGIQ

## **HARMONIA E NGJYRAVE** **Zgjidhni nuancën tuaj**

Familja LOGIQ është krenare për gamën e saj logjike të nuancave të verifikuara dhe elegante të njohura dhe të pëlqyera nga klientët tanë. Mos bëni kompromise, familja LOGIQ e ka zgjidhjen për ju. Ne mund të krijojmë në çdo kohë nuancën e një ngjyre në përputhje me kërkesën tuaj të veçantë. Logjikisht.

## **HARMONY OF COLOURS** **Choose your hue**

The LOGIQ family prides itself on its logical range of verified and elegant hues known and loved by our clients. Don't compromise, the LOGIQ family has you covered. We can always create the hue of colour in accordance with your special request. Logically.

- **antracit** *anthracite*
- **titan** *titanium*
- **e bardhë polare** *polar white*

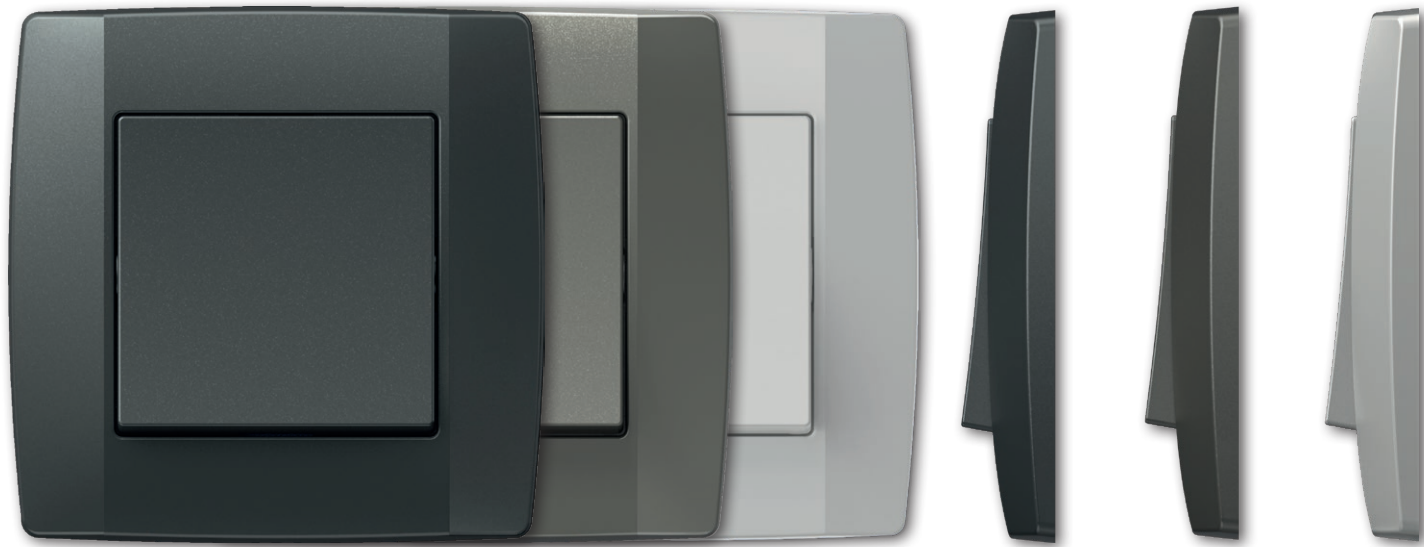

## **IMAGJINATË PA KUFI** **Krijoni kombinimin tuaj**

Familja LOGIQ ju lejon të krijoni kombinimin tuaj. Për ta bërë kombinimin të thjeshtë, kemi krijuar një sistem të dobishëm që mbështet renditjen e linjave horizontale dhe vertikale. Sistemi i ashtuquajtur 55/55 ju lejon të përdorni të njëjtat elemente universale çdo herë. E dini se çfarë dëshironi? Mos u shqetësoni, pasi çelësat LOGIQ mund t'ju lexojnë mendjen.

## LIMITLESS IMAGINATION Create your own combination

The LOGIQ family allows you to create your own combination. To make combining simple, we have created a useful system that supports the sequencing of horizontal and vertical lines. The so-called 55/55 system allows you to use the same universal elements every time. Know what you want? Don't worry, the LOGIQ switches can read your mind.





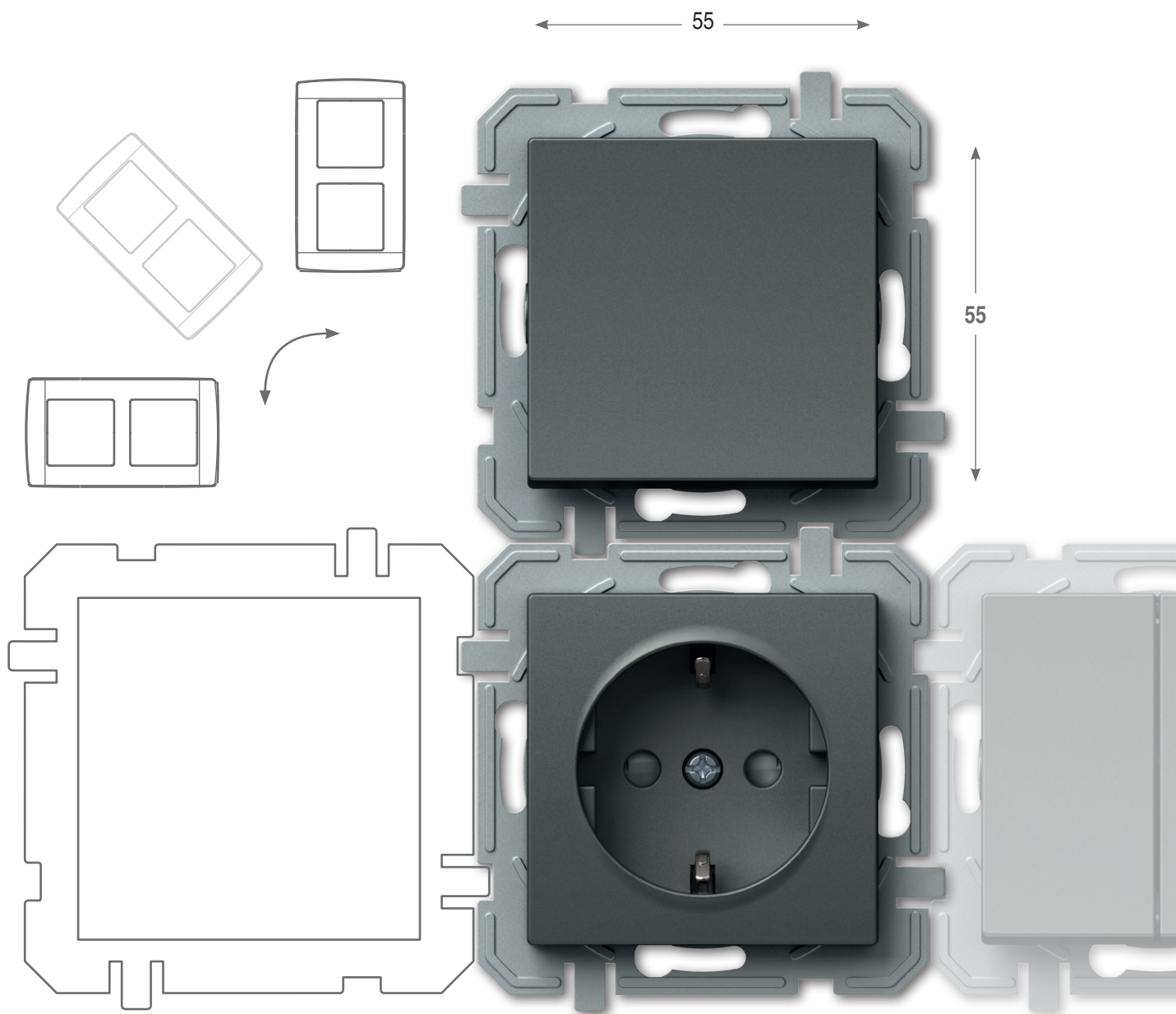

## TË THJESHTË EDHE PËR PERSONAT MË KËRKUES

Familja LOGIQ ofron çelësa, rregullatorë, sensorë, dhe priza për çdo qëllim në një vend të vetëm. Mund t'i përdorni këto produkte individualisht ose në një sekuençë. Si çdo familje rritet dhe zhvillohet, familja LOGIQ do të vazhdojë të zhvillojë gamën tonë të produkteve në përputhje me nevojat dhe dëshirat tuaja. Ne ju dëgjojmë me kënaqësi dhe ofrojmë një zgjidhje e cila do të vazhdojë thjesht dhe logjikisht historinë e familjes LOGIQ.

### SIMPLE FOR THE MOST DEMANDING

The LOGIQ family offers switches, regulators, sensors, and sockets for every purpose in one place. You can use these products individually or in a sequence. Just like every family that grows and develops, the LOGIQ family will continue to develop our range of products in accordance with your needs and wishes. We are happy to listen to you and offer a solution which will simply and logically continue the story of the LOGIQ family.



**TË GJITHA NË NJË VEND DHE MË TEPËR**

ALL IN ONE PLACE AND MORE

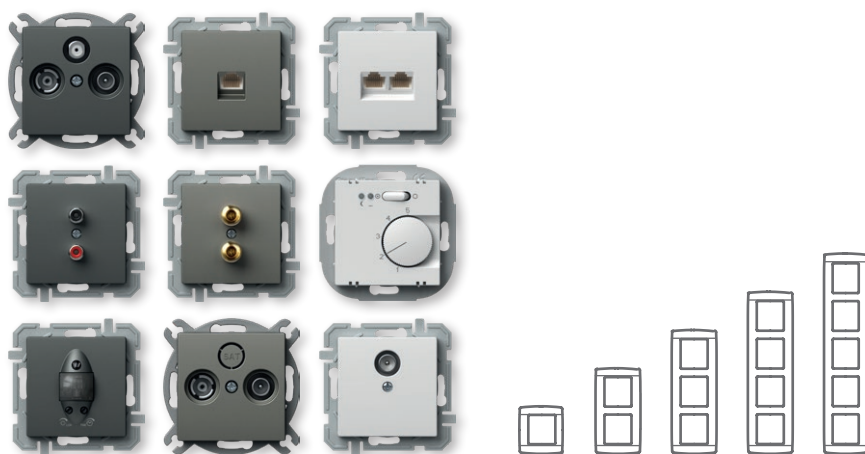

## INSTALIMI LOGJIK

LOGIQ është një zgjidhje për sistemin e kutive të standardizuara të rrumbullakëta të instalimit. Ai mund të përdoret për instalime të thjeshta, si dhe të komplikuar, ndërtesa të reja dhe përshtatje. Sistemi karakterizohet nga kontakte për futje telash që kursejnë kohë gjatë instalimit të elementeve.

## LOGICAL INSTALLATION

LOGIQ is a solution for the system of standardized round installations boxes. It can be used for simple as well as more demanding installations, new buildings and adaptations. The system is characterised by plug-in contacts which save time during installation of elements.

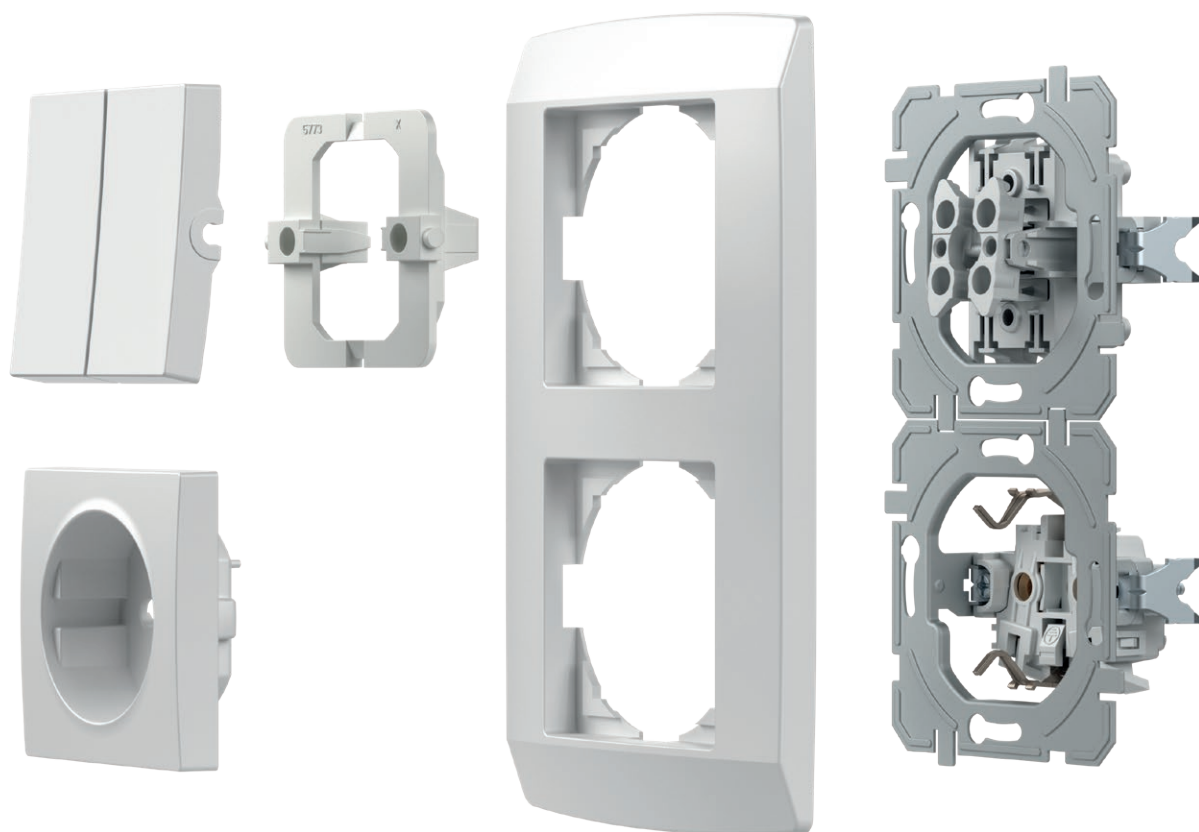

## INFORMACION I DOBISHËM

### GOOD TO KNOW



Të gjitha prizat janë të pajisura me mbyllëse sigurie që garantojnë mbrojtjen e kontakteve nën tension.

All the sockets are equipped with a safety shutters assuring the protection to live contacts.



Një ndërtim çelësi i planifikuar mirë e bën të mundur ndriçimin e thjeshtë edhe më pas.

A well-planned switch construction makes easy illumination possible also subsequently.



Kontaktet prej aliazhi argjendi garantojnë takim-stakim të sigurt.

Contacts made of silver alloy guarantee safe switching.



Kontaktet për futjen e telave mundësojnë bashkim të shpejtë dhe të sigurt të telave. Dy tela me diametër të ndryshëm mund të bashkohen me të njëjtin kontakt.

Plug-in contacts enable quick and reliable attachment of wires. Two wires of different diameters can be attached to the same contact.



Kapëset fiksuese mundësojnë fiksime më të thellë (gjithashtu përmes pllakave qeramike etj.)

Fixing claws enable deeper fixing (also through ceramic tiles, etc.)







Kutitë e instalimit me montim të lehtë do t'ju lehtësojnë punën. Gjatësitë e duhura janë të garantuara.

Easy-fitting installation boxes will make your work easier. Proper lengths are guaranteed.



**SQ11**      **PW**      **IN**      **01**      **XO**

Iloji type	përshkrimi description	të dhënat teknike technical data	ngjyra colour	të dhënat opsionale 1 optional data 1	të dhënat opsionale 2 optional data 2	të dhënat opsionale 3 optional data 3
SQ10	ÇELËS ME 1 DREJTIM SWITCH 1WAY	10AX 250V~	<input type="checkbox"/> PW e bardhë polare polar white	 NT neutral neutral	 01	XO pa kapak mbulues without cover plate
SQ11	BUTON ME SHTYPJE ME 1 DREJTIM PUSH BUTTON 1WAY	10A 250V~	<input type="checkbox"/> TI titan titanium	 IN treguesi indicator	 02	
SQ22	ÇELËS 2-POLAR SWITCH 2POLE	16AX 250V~	<input type="checkbox"/> AT antracit anthracite		 03	
...	...	...	...	...	...	...

ÇELËS ME 1 DREJTIM 10 AX 250 V~

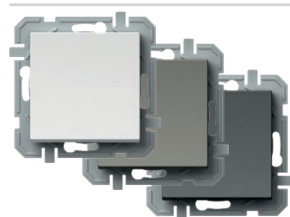

- SQ10PWXO
- SQ10TIXO
- SQ10ATXO



- 10 AX 250 V~, Iloji SQ10  
- në përputhje me EN 60669-1  
- kontakte për futje telash 1,5-2,5 mm<sup>2</sup>  
**SWITCH 1WAY 10AX 250V~**  
- 10AX 250V~, type SQ10  
- in accordance with EN 60669-1  
- plug-in contacts 1.5-2.5mm<sup>2</sup>



ÇELËS ME 1 DREJTIM 10 AX 250 V~ \_\_ IN

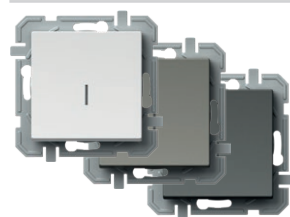

- SQ10PWINXO
- SQ10TIINXO
- SQ10ATINXO



- tregues IN, pa llambë neoni  
- 10 AX 250 V~, Iloji SQ10  
- në përputhje me EN 60669-1  
- kontakte për futje telash 1,5-2,5 mm<sup>2</sup>  
**SWITCH 1WAY 10AX 250V~ \_\_ IN**  
- IN indicator, without neon lamp  
- 10AX 250V~, type SQ10  
- in accordance with EN 60669-1  
- plug-in contacts 1.5-2.5mm<sup>2</sup>



BUTON ME SHTYPJE ME 1 DREJTIM 10A 250 V~

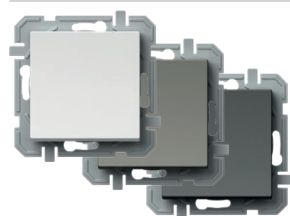

- SQ11PWXO
- SQ11TIXO
- SQ11ATXO



- 10 A 250 V~, Iloji SQ11  
- në përputhje me EN 60669-1  
- kontakte për futje telash 1,5-2,5 mm<sup>2</sup>  
**PUSH BUTTON 1WAY 10A 250V~**  
- 10A 250V~, type SQ11  
- in accordance with EN 60669-1  
- plug-in contacts 1.5-2.5mm<sup>2</sup>



BUTON ME SHTYPJE ME 1 DREJTIM 10A 250V~ \_\_ IN 01

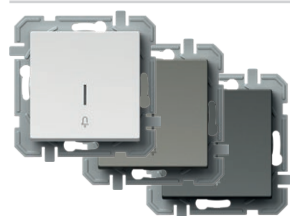

- SQ11PWIN01XO
- SQ11TIIN01XO
- SQ11ATIN01XO



- tregues IN 01 me zile, pa llambë neoni  
- 10 A 250 V~, Iloji SQ11  
- në përputhje me EN 60669-1  
- kontakte për futje telash 1,5-2,5 mm<sup>2</sup>  
**PUSH BUTTON 1WAY 10A 250V~ \_\_ IN 01**  
- IN 01 indicator bell, without neon lamp  
- 10A 250V~, type SQ11  
- in accordance with EN 60669-1  
- plug-in contacts 1.5-2.5mm<sup>2</sup>





- SQ11PWIN02XO
- SQ11TIIN02XO
- SQ11ATIN02XO

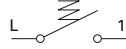

#### BUTON ME SHYTPJE ME 1 DREJTIM 10 A 250 V~ \_\_ IN 02

- dritë treguese IN 02, pa llambë neoni
- 10 A 250 V~, lloji SQ11
- në përputhje me EN 60669-1
- kontakte për futje telash 1,5-2,5 mm<sup>2</sup>

#### PUSH BUTTON 1WAY 10A 250V~ \_\_ IN 02

- IN 02 indicator light, without neon lamp
- 10A 250V~, type SQ11
- in accordance with EN 60669-1
- plug-in contacts 1.5-2.5mm<sup>2</sup>

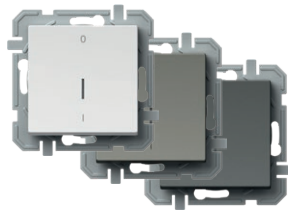

- SQ22PWIN03XO
- SQ22TIIN03XO
- SQ22ATIN03XO

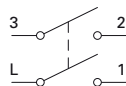

#### ÇELËS 2-POLAR 16 AX 250 V~ \_\_ IN 03

- IN 03 neutral 0-1, pa llambë neoni
- 16 AX 250 V~, lloji SQ22
- në përputhje me EN 60669-1
- kontaktet e vidave 1,5-2,5 mm<sup>2</sup>

#### SWITCH 2POLE 16AX 250V~ \_\_ IN 03

- IN 03 neutral 0-1, without neon lamp
- 16AX 250V~, type SQ22
- in accordance with EN 60669-1
- screw contacts 1.5-2.5mm<sup>2</sup>

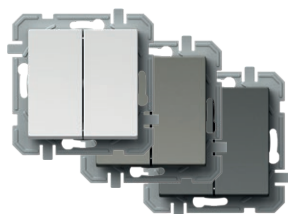

- SQ50PWXO
- SQ50TIXO
- SQ50ATXO

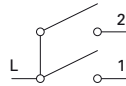

#### ÇELËS ME 2 VENDE - 1 DREJTIM 10 AX 250 V~

- 10 AX 250 V~, lloji SQ50
- në përputhje me EN 60669-1
- kontakte për futje telash 1,5-2,5 mm<sup>2</sup>

#### SWITCH 2GANG-1WAY 10AX 250V~

- 10AX 250V~, type SQ50
- in accordance with EN 60669-1
- plug-in contacts 1.5-2.5mm<sup>2</sup>

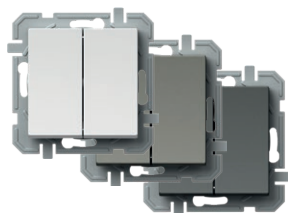

- SQ51PWXO
- SQ51TIXO
- SQ51ATXO

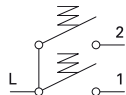

#### BUTON ME SHYTPJE ME 2 VENDE - 1 DREJTIM 10 A 250 V

- 10 A 250 V~, lloji SQ51
- në përputhje me EN 60669-1
- kontakte për futje telash 1,5-2,5 mm<sup>2</sup>

#### PUSH BUTTON 2GANG-1WAY 10A 250V~

- 10A 250V~, type SQ51
- in accordance with EN 60669-1
- plug-in contacts 1.5-2.5mm<sup>2</sup>



- SQ52PWNT09XO
- SQ52TINT09XO
- SQ52ATNT09XO

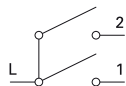

#### MBYLLËSE ÇELËSI 10 AX 250 V~ \_\_ NT 09

- NT 09 neutral lart-poshtë
- 10 AX 250 V~, lloji SQ52
- në përputhje me EN 60669-1
- kontakte për futje telash 1,5-2,5 mm<sup>2</sup>
- me bllokim mekanik

#### SWITCH SHUTTERS 10AX 250V~ \_\_ NT 09

- NT 09 neutral up-down
- 10AX 250V~, type SQ52
- in accordance with EN 60669-1
- plug-in contacts 1.5-2.5mm<sup>2</sup>
- with mechanical interblock



- SQ53PWNT09XO
- SQ53TINT09XO
- SQ53ATNT09XO

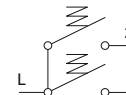

#### MBYLLËSE BUTONI ME SHYTPJE 10 A 250 V~ \_\_ NT 09

- NT 09 neutral lart-poshtë
- 10 A 250 V~, lloji SQ53
- në përputhje me EN 60669-1
- kontakte për futje telash 1,5-2,5 mm<sup>2</sup>
- me bllokim mekanik

#### PUSH BUTTON SHUTTERS 10A 250V~ \_\_ NT 09

- NT 09 neutral up-down
- 10A 250V~, type SQ53
- in accordance with EN 60669-1
- plug-in contacts 1.5-2.5mm<sup>2</sup>
- with mechanical interblock

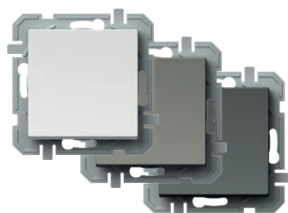

- SQ60PWXO
- SQ60TIXO
- SQ60ATXO

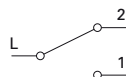

#### ÇELËS ME 2 DREJTIME 10 AX 250 V~

- 10 AX 250 V~, lloji SQ60
- në përputhje me EN 60669-1
- kontakte për futje telash 1,5-2,5 mm<sup>2</sup>

#### SWITCH 2WAY 10AX 250V~

- 10AX 250V~, type SQ60
- in accordance with EN 60669-1
- plug-in contacts 1.5-2.5mm<sup>2</sup>



ÇELËS DYSH ME 2 DREJTIME 10 A X 250 V~



- SQ63PWXO
- SQ63TIXO
- SQ63ATXO

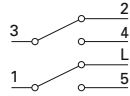

- 10 AX 250 V~, Iloji SQ63  
 - në përputhje me EN 60669-1  
 - kontakte për futje telash 1,5-2,5 mm<sup>2</sup>  
*SWITCH DOUBLE 2WAY 10AX 250V~*  
 - 10AX 250V~, type SQ63  
 - in accordance with EN 60669-1  
 - plug-in contacts 1.5-2.5mm<sup>2</sup>



ÇELËS NDËRMJETËS 10 AX 250 V~

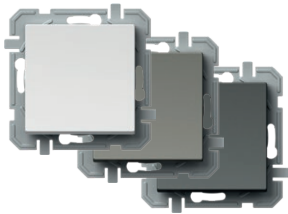

- SQ70PWXO
- SQ70TIXO
- SQ70ATXO

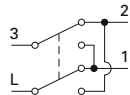

- 10 AX 250 V~, Iloji SQ70  
 - në përputhje me EN 60669-1  
 - kontakte për futje telash 1,5-2,5 mm<sup>2</sup>  
*SWITCH INTERMEDIATE 10AX 250V~*  
 - 10AX 250V~, type SQ70  
 - in accordance with EN 60669-1  
 - plug-in contacts 1.5-2.5mm<sup>2</sup>



SQ10  
SQ11

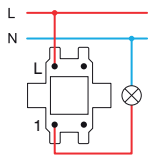

SQ22

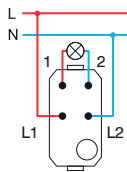

SQ50  
SQ51

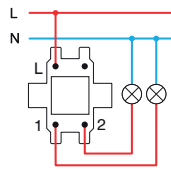

SQ52  
SQ53

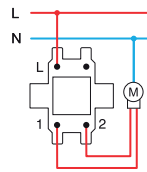

SQ60+SQ60

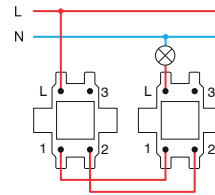

SQ63+SQ63

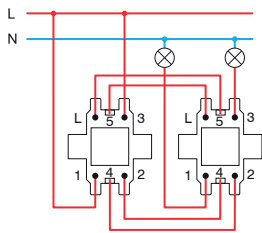

SQ60+SQ70+SQ60

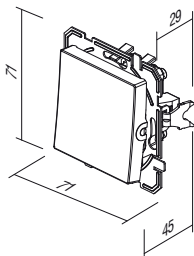
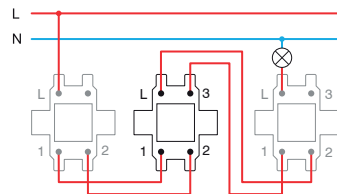



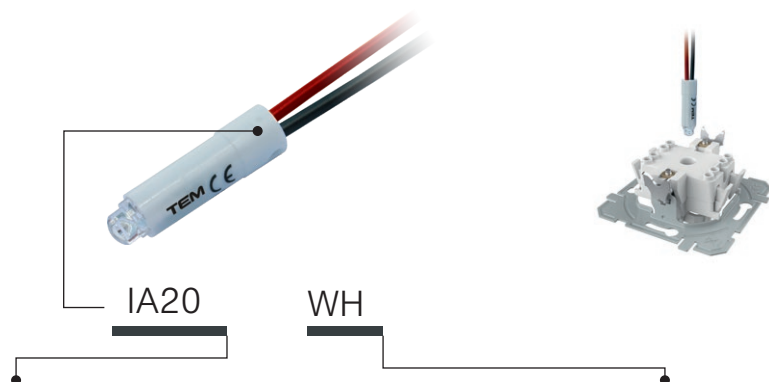

Iloji type	përshkrimi description	të dhënat teknike technical data	ngjyra colour
IA10	LLAMBË NEONI NEON LAMP	230V~ 0,34W	<input type="checkbox"/> WH e bardhë white
IA20	LLAMBË LED LED LAMP	230V~ 0,40W	<input checked="" type="checkbox"/> BL blu blue
IA21	LLAMBË LED LED LAMP	24V AC/DC 0,20W	<input checked="" type="checkbox"/> RD e kuqe red
.	.	.	<input checked="" type="checkbox"/> GR e gjelbër green
.	.	.	<input checked="" type="checkbox"/> OR portokalli orange

## LLAMBË NEONI 230 V~ 0,34 W



 IA10OR

- si tregues, për ndriçim ose ndriçim të vazhdueshëm të çelësit
- në kombinim me butonin me tregues

NEON LAMP 230V~ 0,34W

- for indication, illumination or constant illumination of switch
- in combination with button with indicator

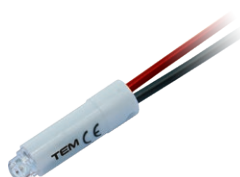
## LLAMBË LED 230 V AC/DC 0,40 W



 IA20WH  
 IA20GR  
 IA20RD  
 IA20BL

- si tregues, për ndriçim ose ndriçim të vazhdueshëm të çelësit
- në kombinim me butonin me tregues

LED LAMP 230V AC/DC 0,40W

- for indication, illumination or constant illumination of switch
- in combination with button with indicator

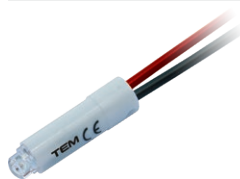
## LLAMBË LED 24 V AC/DC 0,20 W



 IA21WH  
 IA21RD

- si tregues, për ndriçim ose ndriçim të vazhdueshëm të çelësit
- në kombinim me butonin me tregues

LED LAMP 24V AC/DC 0,20W

- for indication, illumination or constant illumination of switch
- in combination with button with indicator

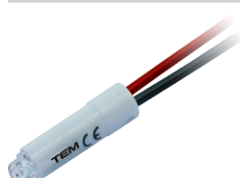
## LLAMBË LED 12 V AC/DC 0,10 W

 IA22WH  
 IA22RD

- si tregues, për ndriçim ose ndriçim të vazhdueshëm të çelësit
- në kombinim me butonin me tregues

LED LAMP 12V AC/DC 0,10W

- for indication, illumination or constant illumination of switch
- in combination with button with indicator

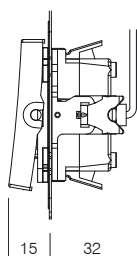

15

32

Tregues  
Indication

\*Ndrëçimi  
Illumination

Ndrëçim konstant  
Illumination always on

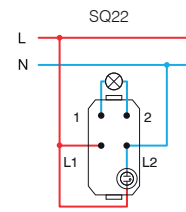
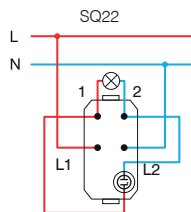
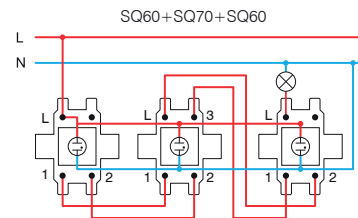
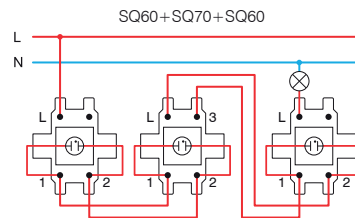
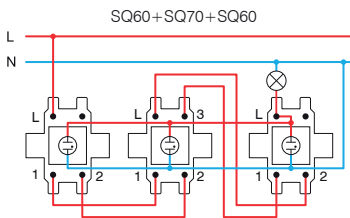
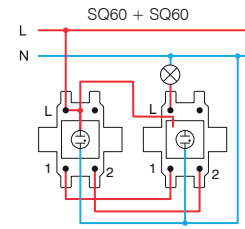
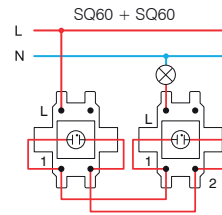
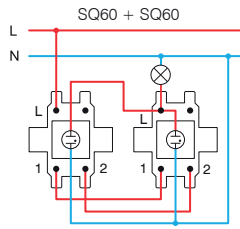
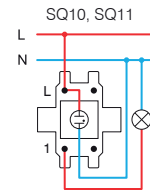
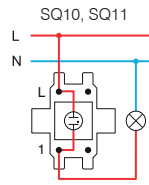
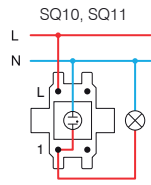

\* lidhjet janë të papërshtatshme për llamba që kursejnë energji (CFL, LED) /  
the connections are not suitable for energy-saving bulbs (CFL, LED)

## S O C K E T S V Q

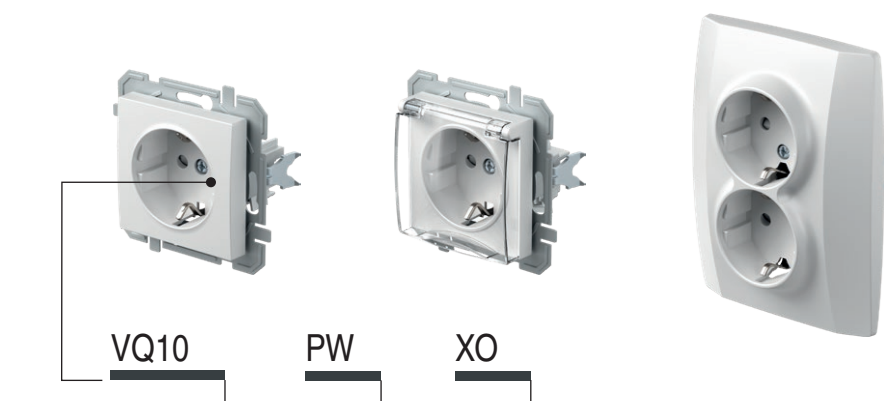

Iloji type	përshkrimi description	të dhënat teknike technical data	të dhënat opsionale 1 optional data 1
VQ10	PRIZË SCHUKO SOCKET SCHUKO	2P+E 16A 250V~	XO pa kapak mbulues without cover plate
VQ11	PRIZË SCHUKO+KAPAK SOCKET SCHUKO+COVER	2P+E 16A 250V~	
VQ12	PRIZË SCHUKO SOCKET SCHUKO	2P+E 16A 250V~ BV	
:	:	:	
:	:	:	

ngjyra  
colour

PW e bardhë polare polar white	PT e bardhë+transparente white+transparent	PP e bardhë+e bardhë white+white
TI titan titanium	TT titan+transparente titanium+transparent	TI titan+titan titanium+titanium
AT antracit anthracite	AT antracit+transparente anthracite+transparent	AA antracit+antracit anthracite+anthracite
RD e kuqe red	RT e kuqe+transparente red+transparent	RR e kuqe+e kuqe red+red
GR e gjelbër green	GT e gjelbër+transparente green+transparent	GG e gjelbër+e gjelbër green+green
OR portokalli orange	OT portokalli+transparente orange+transparent	OO portokalli+portokalli orange+orange



schuko - në përputhje me EN 60884-1, CEE7 (fleta e standardit III)

schuko - in accordance with EN 60884-1, CEE7 (standard sheet III)

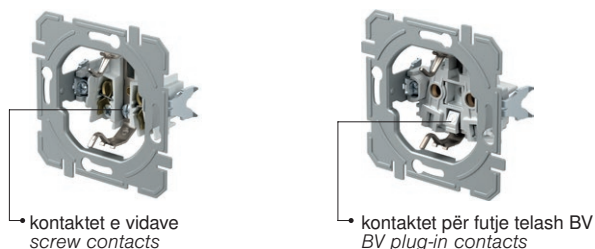

PRIZË SCHUKO 2P+E 16 A 250 V~ \_\_ XO

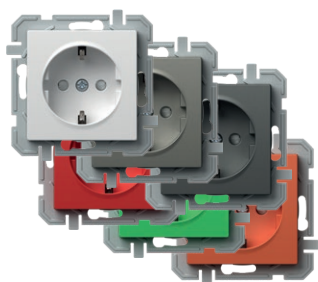

- VQ10PWXO
- VQ10TIXO
- VQ10ATXO
- VQ10RDXO
- VQ10GRXO
- VQ10ORXO

- kontaktet e vidave 1,5-2,5 mm<sup>2</sup>
- XO pa kapak mbulues
- schuko 2P+E
- 16 A 250 V~, lloji VQ10
- mbrojtje e integruar për fëmijët KS - kontakte nën tension të mbyllura



SOCKET SCHUKO 2P+E 16A 250V~ \_\_ XO

- screw contacts 1.5-2.5mm<sup>2</sup>
- XO without surround
- 2P+E schuko
- 16A 250V~, type VQ10
- KS build-in child protection – shuttered live contacts

PRIZË SCHUKO+KAPAK 2P+E 16 A 250 V~ \_\_ XO

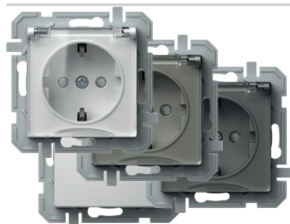

- VQ11PTXO
- VQ11TTXO
- VQ11ATXO
- VQ11PPXO

- kontaktet e vidave 1,5-2,5 mm<sup>2</sup>
- XO pa kapak mbulues
- schuko 2P+E schuko+kapak
- 16 A 250 V~, lloji VQ11
- mbrojtje e integruar për fëmijët KS - kontakte nën tension të mbyllura



SOCKET SCHUKO+COVER 2P+E 16A 250V~ \_\_ XO

- screw contacts 1.5-2.5mm<sup>2</sup>
- XO without surround
- 2P+E schuko+cover
- 16A 250V~, type VQ11
- KS build-in child protection – shuttered live contacts

PRIZË SCHUKO 2P+E 16 A 250 V~ BV \_\_ XO

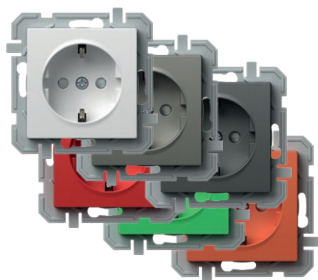

- VQ12PWXO
- VQ12TIXO
- VQ12ATXO
- VQ12RDXO
- VQ12GRXO
- VQ12ORXO

- BV kontakte për futje telash 1,5-2,5 mm<sup>2</sup>
- XO pa kapak mbulues
- schuko 2P+E
- 16 A 250 V~, lloji VQ12
- mbrojtje e integruar për fëmijët KS - kontakte nën tension të mbyllura



SOCKET SCHUKO 2P+E 16A 250V~ BV \_\_ XO

- BV plug-in contacts 1.5-2.5mm<sup>2</sup>
- XO without surround
- 2P+E schuko
- 16A 250V~, type VQ12
- KS build-in child protection – shuttered live contacts

PRIZË SCHUKO+KAPAK 2P+E 16 A 250 V~ BV \_\_ XO

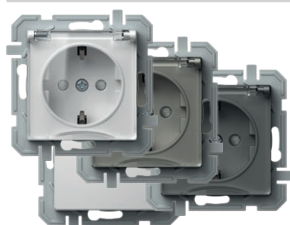

- VQ13PTXO
- VQ13TTXO
- VQ13ATXO
- VQ13PPXO

- kontakte BV për futje telash 1,5-2,5 mm<sup>2</sup>
- XO pa kapak mbulues
- schuko 2P+E schuko+kapak
- 16 A 250 V~, lloji VQ13
- mbrojtje e integruar për fëmijët KS - kontakte nën tension të mbyllura



SOCKET SCHUKO+COVER 2P+E 16A 250V~ BV \_\_ XO

- BV plug-in contacts 1.5-2.5mm<sup>2</sup>
- XO without surround
- 2P+E schuko+cover
- 16A 250V~, type VQ13
- KS build-in child protection – shuttered live contacts

PRIZË SCHUKO DYSHE 2P+E 16 A 250 V~



- VQ16PW
- VQ16TI
- VQ16AT

- schuko dyshe 2P+E
- 16 A 250 V~, lloji VQ16
- në përputhje me IEC 60884-1, CEE7
- kontaktet e vidave 1,5-2,5 mm<sup>2</sup>
- mbrojtje e integruar për fëmijët KS - kontakte nën tension të mbyllura



SOCKET SCHUKO DOUBLE 2P+E 16A 250V~

- 2P+E schuko double
- 16A 250V~, type VQ16
- in accordance with IEC 60884-1, CEE7
- screw contacts 1.5-2.5 mm<sup>2</sup>
- KS build-in child protection – shuttered live contacts

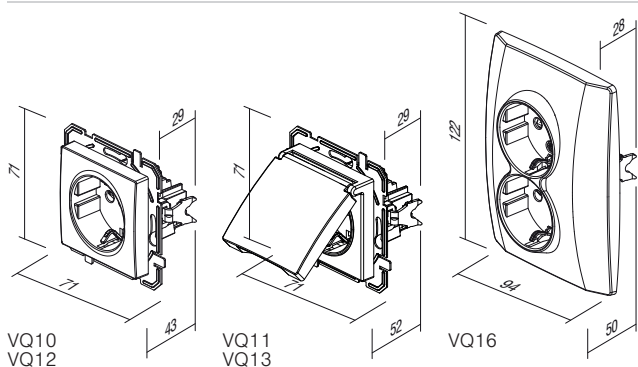

VQ10  
VQ12

VQ11  
VQ13

VQ16

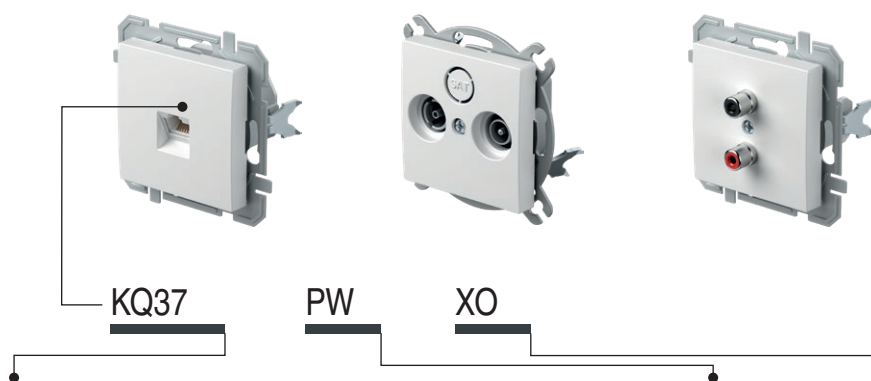

Iloji type	përshkrimi description	të dhënat teknike technical data	ngjyra colour	të dhënat opsionale 1 optional data 1
KQ11	PRIZË TV-R ME KAPAK FUNDOR SOCKET TV-R END-LINE	1dB	<input type="checkbox"/> PW e bardhë polare polar white	XO pa kapak mbulues without cover plate
KQ12	PRIZË TV-R KALUESE SOCKET TV-R THROUGHPASS	10dB	<input type="checkbox"/> TI titan titanium	
KQ16	PRIZË SAT-TV-R ME KAPAK FUNDOR SOCKET SAT-TV-R END-LINE	3dB	<input type="checkbox"/> AT antracit anthracite	
⋮		⋮		

## PRIZË TV BAZË 0 dB



- KQ10PW
- KQ10TI
- KQ10AT

- TV bazë
- reduktim 0 dB
- konektor i pasmë – F standard

## SOCKET TV BASIC 0dB

- TV basic
- reduction 0dB
- back connector – F standard



## PRIZË TV-R ME KAPAK FUNDOR 1 dB



- KQ11PW
- KQ11TI
- KQ11AT

- TV-R me kapak fundor
- gama e frekuencës 5÷862 MHz
- reduktimi: R-1,5 dB, TV-1 dB
- në përputhje me EN 50083-1
- kontakti i vidave

## SOCKET TV-R END-LINE 1dB

- TV-R end-line
- frequency range 5÷862 MHz
- reduction: R-1.5dB, TV-1dB
- in accordance with EN 50083-1
- screw contact



## PRIZË TV-R KALUESE 10 dB



- KQ12PW
- KQ12TI
- KQ12AT

- TV-R kaluese
- gama e frekuencës 5÷862 MHz
- reduktimi: R-10 dB, TV-10 dB, kaluese-2 dB
- në përputhje me EN 50083-1
- kontaktet e vidave

## SOCKET TV-R THROUGHPASS 10dB

- TV-R throughpass
- frequency range 5÷862 MHz
- reduction: R-10dB, TV-10dB, through-2dB
- in accordance with EN 50083-1
- screw contacts



## PRIZË SAT-TV-R ME KAPAK FUNDOR 3 dB



- KQ16PW
- KQ16TI
- KQ16AT

- SAT-TV-R me kapak fundor
- gama e frekuencës 5÷2400 MHz
- reduktimi: R-1 dB, TV-1.5 dB, SAT-3 dB
- në përputhje me EN 50083-1
- kontaktet e vidave

## SOCKET SAT-TV-R END-LINE 3dB

- SAT-TV-R end-line
- frequency range 5÷2400 MHz
- reduction: R-1dB, TV-1.5dB, SAT-3dB
- in accordance with EN 50083-1
- screw contacts



PRIZË AUDIO 2xRCA



- KQ22PWXO
- KQ22TIXO
- KQ22ATXO

- audio 2xRCA  
 - lidhje me saldim e kablos  
**SOCKET AUDIO 2xRCA**  
 - audio 2xRCA  
 - soldering connection of cable



PRIZË AUDIO PËR ALTOPARLANTË



- KQ23PWXO
- KQ23TIXO
- KQ23ATXO

- audio 2x Ø4 mm  
 - për të mbajtur telin e altoparlantit, spinë banane Ø4mm ose pirun  
 - lidhje me ngjitje e kablos në pjesën e pasme  
**SOCKET AUDIO LOUDSPEAKERS**  
 - audio 2x Ø4mm  
 - to accommodate speaker wire, banana plug Ø4mm or spades  
 - soldering connection of cable at the back side



PRIZË TEL KS RJ11 6/4

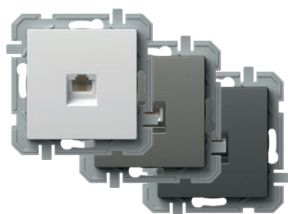

- KQ36PWXO
- KQ36TIXO
- KQ36ATXO

- standard fiksues trapez KS  
 - RJ11 6/4  
 - në përputhje me IEC 60603-7  
**SOCKET TEL KS RJ11 6/4**  
 - KS keystone fixing standard  
 - RJ11 6/4  
 - in accordance with IEC 60603-7



PRIZË CAT5e KS RJ45 8/8

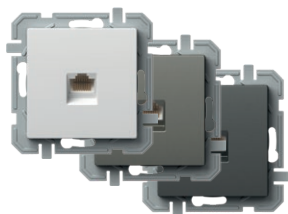

- KQ37PWXO
- KQ37TIXO
- KQ37ATXO

- standard fiksues trapez KS  
 - CAT5e, RJ45 8/8  
 - në përputhje me IEC 60603-7  
**SOCKET CAT5e KS RJ45 8/8**  
 - KS keystone fixing standard  
 - CAT5e, RJ45 8/8  
 - in accordance with IEC 60603-7



PRIZË TEL KS DYSHE 2x RJ11 6/4

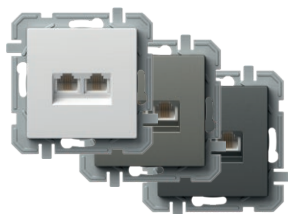

- KQ38PWXO
- KQ38TIXO
- KQ38ATXO

- standard fiksues trapez KS  
 - 2x RJ11, 6/4  
 - në përputhje me IEC 60603-7  
**SOCKET TEL KS DOUBLE 2x RJ11 6/4**  
 - KS keystone fixing standard  
 - 2x RJ11, 6/4  
 - in accordance with IEC 60603-7



PRIZË CAT5e KS DYSHE 2x RJ45 8/8

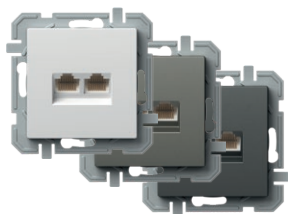

- KQ39PWXO
- KQ39TIXO
- KQ39ATXO

- standard fiksues trapez KS  
 - 2x CAT5e, RJ45 8/8  
 - në përputhje me IEC 60603-7  
**SOCKET CAT5e KS DOUBLE 2x RJ45 8/8**  
 - KS keystone fixing standard  
 - 2x CAT5e, RJ45 8/8  
 - in accordance with IEC 60603-7



PRIZË TEL LT RJ11 6/4

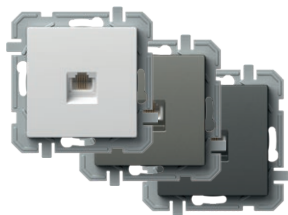

- KQ35PWXO
- KQ35TIXO
- KQ35ATXO

- vidë TEL LT  
 - kontaktet e vidave  
 - RJ11 6/4  
 - në përputhje me IEC 60603-7  
**SOCKET TEL LT RJ11 6/4**  
 - TEL LT screw  
 - screw contacts  
 - RJ11 6/4  
 - in accordance with IEC 60603-7



PRIZË CAT6s KS RJ45 8/8 E HOLLË

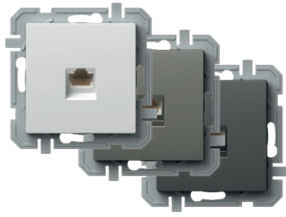

- KQ40PWXO
- KQ40TIXO
- KQ40ATXO

- standard fiksues trapez KS
- CAT6s, RJ45 8/8
- në përputhje me IEC 60603-7

SOCKET CAT6s KS RJ45 8/8 SLIM

- KS keystone fixing standard
- CAT6s, RJ45 8/8
- in accordance with IEC 60603-7



PRIZË CAT6s KS DYSHE 2x RJ45 8/8 E HOLLË

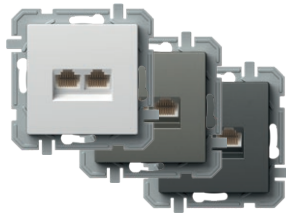

- KQ41PWXO
- KQ41TIXO
- KQ41ATXO

- standard fiksues trapez KS
- 2x CAT6s, RJ45 8/8
- në përputhje me IEC 60603-7

SOCKET CAT6s KS DOUBLE 2x RJ45 8/8 SLIM

- KS keystone fixing standard
- 2x CAT6s, RJ45 8/8
- in accordance with IEC 60603-7

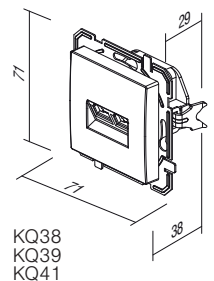
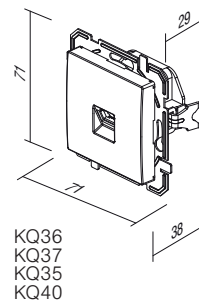
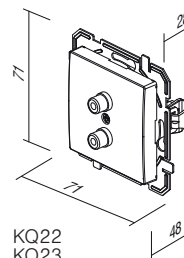
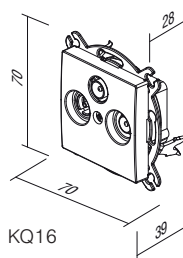
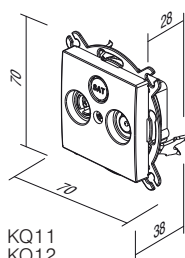
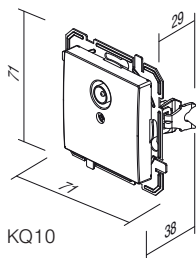



EQ15

PW

XO

lloji type	përshkrimi description	të dhënat teknike technical data	ngjyra colour	të dhënat opsionale 1 optional data 1
EQ15	REOSTAT RROTULLUES ME 2 DREJTIME DIMMER ROTATIVE 2WAY	RL 400W	<input type="checkbox"/> PW e bardhë polare polar white	XO pa kapak mbulues without cover plate
EQ16	REOSTAT RROTULLUES ME 2 DREJTIME DIMMER ROTATIVE 2WAY	RLC 400W	<input type="checkbox"/> TI titan titanium	
EQ19	REOSTAT RROTULLUES ME 2 DREJTIME DIMMER ROTATIVE 2WAY	LED 100W	<input type="checkbox"/> AT antracit anthracite	
⋮		⋮		

#### REOSTAT RROTULLUES ME 2 DREJTIME RL 400 W



- EQ15PWXO
- EQ15TIXO
- EQ15ATXO

- kontroll i rrotullimit me çelës me 2 drejtime
- RL i ngarkesës, 40 W - 400W
- është i mundur kombinimi i çelësit me 2 drejtime
- nuk lejohet kombinimi i më shumë reostateve
- në përputhje me standardet EN 60669-1 dhe EN 60669-2-1
- kontakte për futje telash 1,5 mm<sup>2</sup>
- furnizimi, 230 V ~ 50 Hz
- përfshihet siguresa e zëvendësueshme



#### DIMMER ROTATIVE 2WAY RL 400W

- rotation control with 2-way switch
- load RL, 40W - 400W
- 2-way switch combination is possible
- more dimmers combination is not allowed
- in accordance with EN 60669-1 and EN 60669-2-1
- plug-in contacts 1.5mm<sup>2</sup>
- supply 230V~ 50Hz
- replaceable fuse included

#### REOSTAT RROTULLUES ME 2 DREJTIME RLC 400 W



- EQ16PWXO
- EQ16TIXO
- EQ16ATXO

- kontroll i rrotullimit me çelës me 2 drejtime
- RLC i ngarkesës, 20W - 400W
- është i mundur kombinimi i çelësit me 2 drejtime
- nuk lejohet kombinimi i më shumë reostateve
- në përputhje me standardet EN 60669-1 dhe EN 60669-2-1
- kontakte për futje telash 1,5 mm<sup>2</sup>
- furnizimi, 230 V ~ 50 Hz
- siguresë elektronike



#### DIMMER ROTATIVE 2WAY RLC 400W

- rotation control with 2-way switch
- load RLC, 20W - 400W
- 2-way switch combination is possible
- more dimmers combination is not allowed
- in accordance with EN 60669-1 and EN 60669-2-1
- plug-in contacts 1.5mm<sup>2</sup>
- supply 230V~ 50Hz
- electronic fuse

#### REOSTAT RROTULLUES ME 2 DREJTIME LED 100 W



- EQ19PWXO
- EQ19TIXO
- EQ19ATXO

- kontroll i rrotullimit me çelës me 2 drejtime
- ngarkesa: LED, 0-100 W (maks. 10 LED-e)  
GLS, 10-250 W
- është i mundur kombinimi i çelësit me 2 drejtime
- nuk lejohet kombinimi i më shumë reostateve
- në përputhje me standardet EN 60669-1 dhe EN 60669-2-1
- kontakte për futje telash 1,5 mm<sup>2</sup>
- furnizimi, 230 V ~ 50 Hz
- përfshihet siguresa e zëvendësueshme



#### DIMMER ROTATIVE 2WAY LED 100W

- rotation control with 2-way switch
- load: LED, 0-100W (max. 10 LEDs)  
GLS, 10-250W
- 2-way switch combination is possible
- more dimmers combination is not allowed
- in accordance with EN 60669-1 and EN 60669-2-1
- plug-in contacts 1.5mm<sup>2</sup>
- supply 230V~ 50Hz
- replaceable fuse included



EQ15, EQ16, EQ19

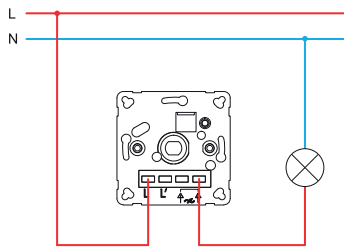

EQ15, EQ16, EQ19

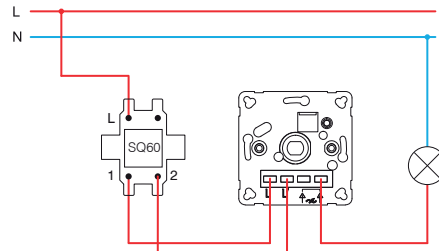

EQ15, EQ16, EQ19

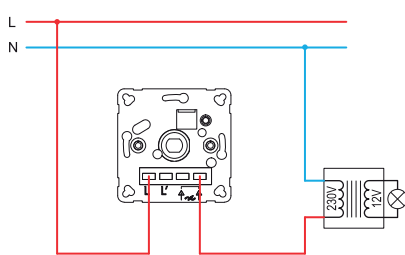

EQ15, EQ16, EQ19

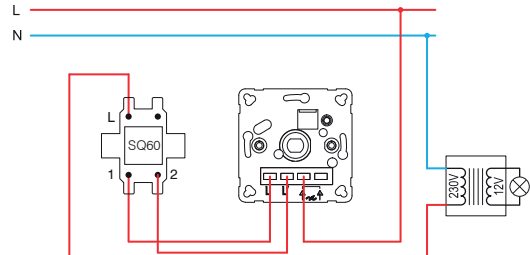

EQ16, EQ19

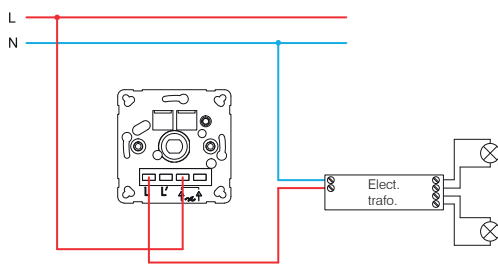

EQ16, EQ19

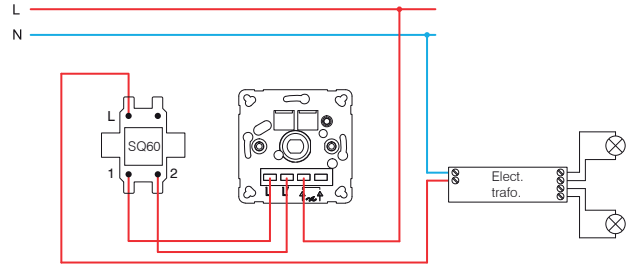

**EQ15 (40÷400W)**

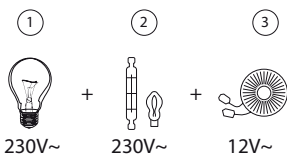

- 1 - llambë inkandeshente  
*incandescent lamp*
- 2 - llambë halogjene  
*halogen lamp*

**EQ16 (20÷400W)**

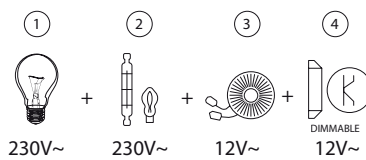

- 3 - transformator klasik  
*classical transformer*
- 4 - transformator elektrik me ule ndriçimi  
*dimmable electronic transformer*

**EQ19 (GLS 10÷250W ; LED 0÷100W)**

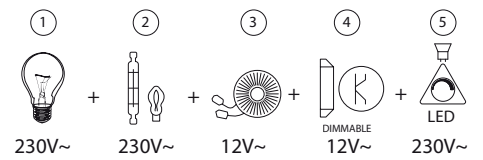

- 5 - llambë LED me ulje ndriçimi  
*dimmable LED lamp*

ÇELËS IR 5A X 230 V~



- EQ32PW XO
- EQ32TIXO
- EQ32ATXO

- çelës IR me infra të kuqe
- tensioni i furnizimit: 230 V~ ±10 % 50 Hz
- rele: 5 A / 250 V~ dalja për rrymën e kufizuar me rezistencë të lartë për kryqëzim zero
- vlerësimi i mbrojtjes: IP40
- prerja e tërthortë e telave në terminalin e kontaktit: 0,75 - 2,5 mm<sup>2</sup>
- zona e zbulimit: deri në 110° në 20°C
- zona e zbulimit: rreth 8 m në 20°C
- rregullimi i kohëzgjatjes: nga rreth 5 sek. deri në 12 min.
- rregullimi i ndriçimit: nga rreth 5 deri në 200 LUX
- temperatura e funksionimit: nga 0°C deri në +40°C
- i papërshtatshëm për instalim në kuti me thellësi 45 mm
- vetëm për përdorim të brendshëm

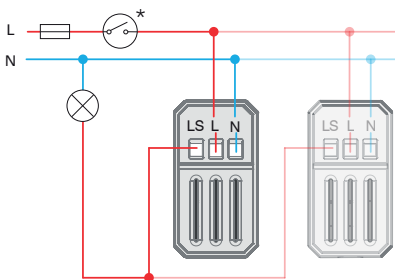

IR SWITCH 5A 230V~

- IR infrared switch
- supply voltage: 230V~ ±10 % 50Hz
- relay: 5A / 250V~ output for limited current with high resistance for zero crossing
- protection rating: IP40
- cross-section of wires at the contact terminal: 0.75 - 2.5 mm<sup>2</sup>
- detection angle: up to 110° at 20°C
- detection area: approx. 8 m at 20°C
- adjustability of duration: from approx. 5 s to 12 min
- adjustability of brightness: from approx. 5 to 200 LUX
- operating temperature: from 0°C to +40°C
- not suitable for installation in 45 mm deep boxes
- only for indoor usage

TERMOSTAT PËR NGROHJE 10 A 230 V~

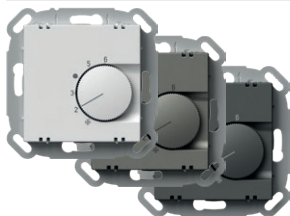

- EQ35PW XO
- EQ35TIXO
- EQ35ATXO

- modaliteti i funksionimit: ngrohje
- furnizimi me energji: 230 V~, 50 Hz
- dalja: 4 A (maks. 10 A), 230 V~, 50 Hz
- kontakti i takim-stakimit: NC (maks. 10 aktivizues)
- gama e rregullimit: +5 °C deri në +30 °C
- histereza: 0,5 K
- mbrojtja: IP30
- lloji i sensorit: dymetalik
- lloji i lidhjes elektrike: kontakte me susta
- lloji i përcuesve: 0,75 – 1,5 mm<sup>2</sup> (bërthamë me fije fleksibël) ose 1,0 – 2,5 mm<sup>2</sup> (bërthamë e fortë)

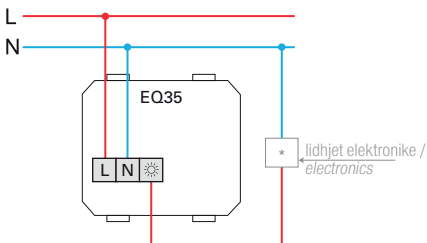

THERMOSTAT HEATING 10A 230V~

- operation mode: heating
- power supply: 230 V~, 50 Hz
- output: 4 A (max. 10 A), 230 V~, 50 Hz
- switching contact: NC (max. 10 actuators)
- regulation range: +5 °C to +30 °C
- hysteresis: 0,5 K
- protection: IP30
- sensor type: bimetal
- type of electrical connection: spring-loaded contacts
- type of conductors: 0,75 – 1,5mm<sup>2</sup> (flexible-stranded core) or 1,0 – 2,5 mm<sup>2</sup> (solid core)

TERMOSTAT PËR NGROHJE/FTOHJE 5 A 230 V~

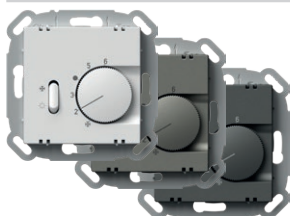

- EQ36PW XO
- EQ36TIXO
- EQ36ATXO

- modaliteti i funksionimit: ngrohje/ftohje
- furnizimi me energji: 230 V~, 50 Hz
- dalja: 2 A (maks. 5 A), 230 V~, 50 Hz
- kontakti i takim-stakimit: komutatori (ndërrues, maks. 5 aktivizues)
- gama e rregullimit: +5 °C deri në +30 °C
- histereza: 0,5 K
- mbrojtja: IP30
- lloji i sensorit: dymetalik
- lloji i lidhjes elektrike: kontakte me susta
- lloji i përcuesve: 0,75 – 1,5 mm<sup>2</sup> (bërthamë me fije fleksibël) ose 1,0 – 2,5 mm<sup>2</sup> (bërthamë e fortë)

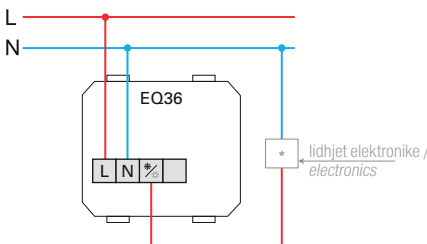

THERMOSTAT HEATING / COOLING 5A 230V~

- operation mode: heating / cooling
- power supply: 230 V~, 50 Hz
- output: 2 A (max. 5 A), 230 V~, 50 Hz
- switching contact: changeover switch (toggler, max. 5 actuators)
- regulation range: +5 °C to +30 °C
- hysteresis: 0,5 K
- protection: IP30
- sensor type: bimetal
- type of electrical connection: spring-loaded contacts
- type of conductors: 0,75 – 1,5mm<sup>2</sup> (flexible-stranded core) or 1,0 – 2,5 mm<sup>2</sup> (solid core)

NGROHJE ME TERMOSTAT NGA DYSHEMEJA 16 A 230 V~

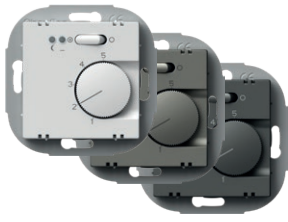

- EQ37PWXO
- EQ37TIXO
- EQ37ATXO

- modaliteti i funksionimit: ngrohje nga dyshemeja
- furnizimi me energji: 230 V~, 50 Hz
- dalja: 2 A (maks. 16 A), 230 V~, 50 Hz
- gama e rregullimit: +10 °C deri në +50 °C
- histereza: 1 K
- mbrojtja: IP30
- lloji i sensorit: NTC në përputhje me DIN EN 60730-2-1
- treguesit: LED i kuq për ngrohje dhe LED i gjelbër për modalitetin e uljes së dritës gjatë natës
- lloji i lidhjes elektrike: Kontaktet e vidave
- lloji i përçuesve: 0,5 – 2,5 mm<sup>2</sup>

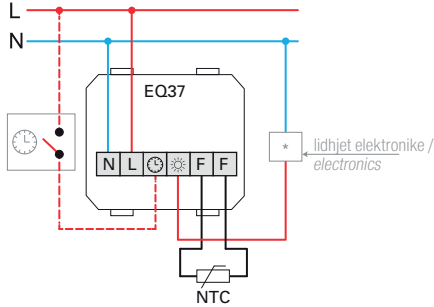

THERMOSTAT FLOOR HEATING 16A 230V~

- operation mode: floor heating
- power supply: 230 V~, 50 Hz
- output: 2 A (max. 16 A), 230 V~, 50 Hz
- regulation range: +10 °C to +50 °C
- hysteresis: 1 K
- protection: IP30
- sensor type: NTC in compliance with DIN EN 60730-2-1
- indicators: Red LED for heating and green LED for night decrease mode
- type of electrical connection: Screw contacts
- type of conductors: 0,5 – 2,5mm<sup>2</sup>

NJËSI USB E FURNIZIMIT ME ENERGJI 5 V 3,0 A



- EQ68PW
- EQ68TI
- EQ68AT

- për karikimin e pajisjeve elektronike përmes një porte standarde USB (e përputhshme gjithashtu me pajisjet Apple)
- furnizimi me energji: 100-230 V~ 50/60 Hz
- konsumi i energjisë: 300 mA në 100 V~/150 mA në 230 V~
- konsumi i energjisë në gatishmëri: 30 mW në 230 V~
- tensioni nominal në dalje: 5 VCD (±5 %) SELV
- tensioni pulsant në dalje: 150 mV
- rryma nominale në dalje: 3.0 A (±10%)
- lloji i konektorit: USB A/USB C
- efikasiteti: maksimumi 77%
- temperatura e funksionimit: 0 °C/+45 °C (përdorimi i brendshëm)
- klasi i mbrojtjes IP: IP20, vetëm për përdorim në ambiente të brendshme
- klasi i pajisjes II
- kategoria e mbtensionit (EN 62109): Klasi III
- kontaktet e vidave: maks. 2.5 mm<sup>2</sup>
- pajisje me hapësirë kontakti prej të paktën 3 mm
- në përputhje me standardet EN 60950-1 dhe direktivave LVD dhe EMC



USB POWER SUPPLY UNIT 5V 3.0A

- for charging electronic devices via a standard USB port (also compatible with Apple devices)
- power supply: 100-230V~ 50/60Hz
- power consumption: 300mA at 100V~/150mA at 230V~
- standby power consumption: 30mW at 230V~
- nominal output voltage: 5 VCD (± 5%) SELV
- output ripple voltage: 150mV
- nominal output current: 3.0 A (±10%)
- connector type: USB A / USB C
- efficiency: maximum of 77%
- operating temperature: 0°C/+45°C (indoor use)
- IP protection class: IP20, indoor use only
- class device II
- overvoltage category (EN 62109): Class III
- screw contacts: max. 2.5 mm<sup>2</sup>
- device with a contact gap of at least 3mm
- in accordance with the EN 60950-1 and LVD & EMC directives

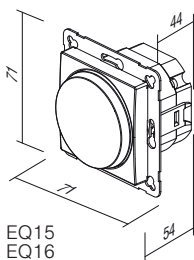

EQ15  
EQ16  
EQ19

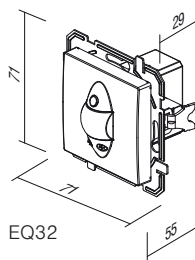

EQ32

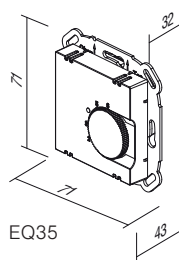

EQ35

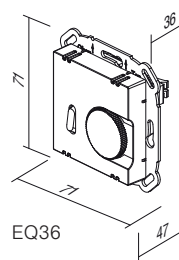

EQ36

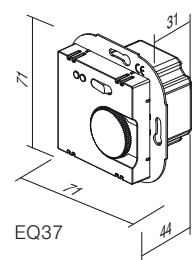

EQ37

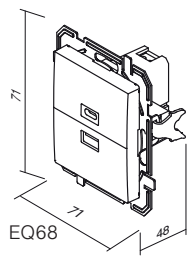

EQ68

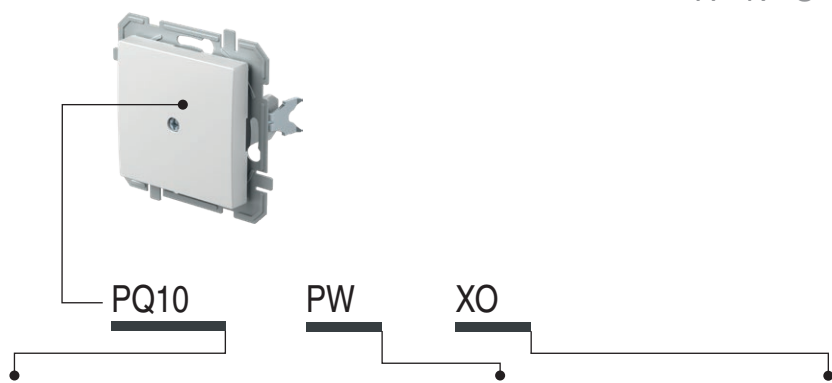

lloji type	përshkrimi description	ngjyra colour	të dhënat opsionale 1 optional data 1
PQ10	TAPË BLANK	□ PW e bardhë polare polar white	XO pa kapak mbulues without cover plate
PQ30	KAPAK TAE/TDO COVER TAE/TDO	■ TI titan titanium ■ AT antracit anthracite	

#### TAPË



- PQ10PWXO
- PQ10TIXO
- PQ10ATXO

- për mbushjen e hapësirave boshe  
*BLANK*  
- for filling up empty spaces



#### KAPAK TAE/TDO

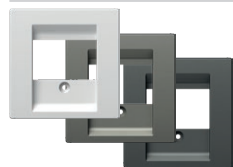



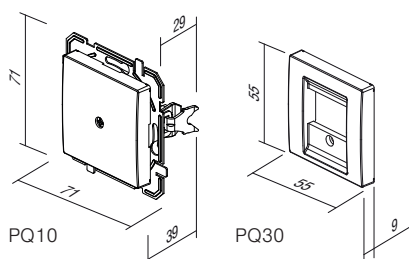

- PQ30PW
- PQ30TI
- PQ30AT

- kapak TAE ose TDO me vidë  
*COVER TAE/TDO*  
- TAE or TDO cover with screw

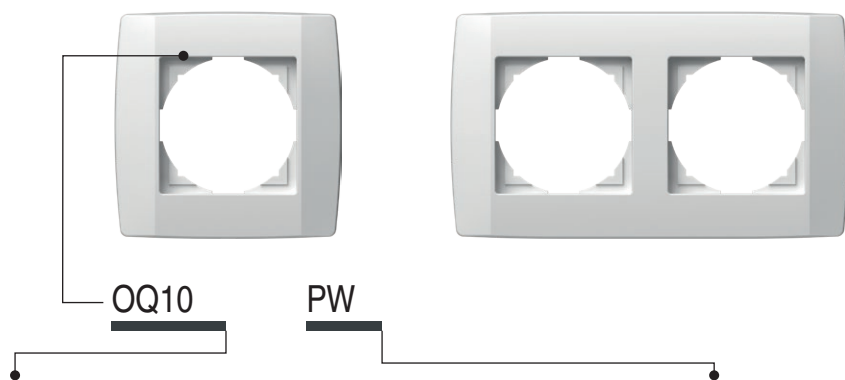

## C O V E R P L A T E S O Q



lloji type	përshkrimi description	ngjyra colour
OQ10	KAPAK MBULUES LOGIQ 1 COVER PLATE LOGIQ 1	 PW e bardhë polare polar white
OQ20	KAPAK MBULUES LOGIQ 2 COVER PLATE LOGIQ 2	 TI titan titanium
OQ30	KAPAK MBULUES LOGIQ 3 COVER PLATE LOGIQ 3	 AT antracit anthracite
:		
:		



 OQ10PW  
 OQ10TI  
 OQ10AT

## KAPAK MBULUES LOGIQ 1

- kapakë mbulues dekorativë me 1 vend  
- në përputhje me EN 60669-1

**COVER PLATE LOGIQ 1**  
- decorative cover plate 1-gang  
- in accordance with EN 60669-1

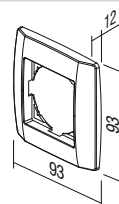

 OQ20PW  
 OQ20TI  
 OQ20AT

## KAPAK MBULUES LOGIQ 2

- kapak mbulues dekorativ me 2 vende  
- në përputhje me EN 60669-1

**COVER PLATE LOGIQ 2**  
- decorative cover plate 2-gang  
- in accordance with EN 60669-1

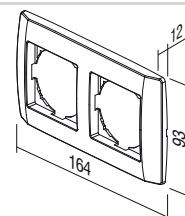

KAPAK MBULUES LOGIQ 3



- OQ30PW
- OQ30TI
- OQ30AT

- kapak mbulues dekorativ me 3 vende
- në përputhje me EN 60669-1

*COVER PLATE LOGIQ 3*  
 - decorative cover plate 3-gang  
 - in accordance with EN 60669-1

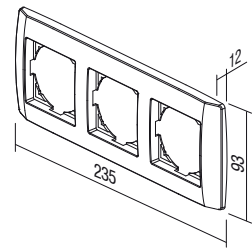

KAPAK MBULUES LOGIQ 4



- OQ40PW
- OQ40TI
- OQ40AT

- kapak mbulues dekorativ me 4 vende
- në përputhje me EN 60669-1

*COVER PLATE LOGIQ 4*  
 - decorative cover plate 4-gang  
 - in accordance with EN 60669-1

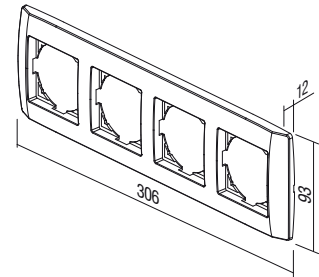

KAPAK MBULUES LOGIQ 5



- OQ50PW
- OQ50TI
- OQ50AT

- kapak mbulues dekorativ me 5 vende
- në përputhje me EN 60669-1

*COVER PLATE LOGIQ 5*  
 - decorative cover plate 5-gang  
 - in accordance with EN 60669-1

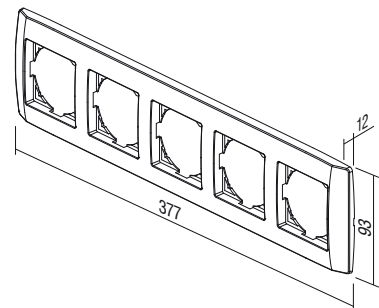



TEM

ekonomik







# ekonomik

## **PLANIFIKUAR PËR PËRSOSMËRI** **Stili është thelbësor**

Një dizajn neutral, kompakt dhe elegant mund të përshtatet me çdo ambient pune ose banimi. Nuk dallon nga ambienti i brendshëm, por në të kundërt përshtatet me të në mënyrë harmonike.

## PLANNED FOR EXCELLENCE Style is essential

A neutral, compact, elegant design is adjustable to every working or living area. It does not stick out from the interior, but rather harmonically fits into it.





# ekonomik

## HARMONIA E NGJYRAVE Zgjidhni nuancën tuaj

Dëshirat mund të jenë shumë të ndryshme. Prandaj, ne kemi zgjedhur me kujdes mundësitë për ju, që mund t'ju ofrojnë përgjigjen e duhur. Një paletë neutrale ngjyrash vetëm thjesht do ta plotësojë ambientin tuaj - nuk do ta kufizojë atë.

## HARMONY OF COLOURS Choose your hue

Desires can be very different. Therefore we have carefully selected possibilities for you, which can offer you the right answer. A neutral palette of colours will only complement your ambient - it will not restrict it.

- |                             |                               |                        |
|-----------------------------|-------------------------------|------------------------|
| <input type="checkbox"/> PW | <b>e bardhë polare</b>        | <i>polar white</i>     |
| <input type="checkbox"/> IW | <b>e bardhë fildishi</b>      | <i>ivory white</i>     |
| <input type="checkbox"/> ES | <b>e argjendë elox</b>        | <i>elox silver</i>     |
| <input type="checkbox"/> CO | <b>e bardhë termoplastike</b> | <i>white thermoset</i> |
| <input type="checkbox"/> NB | <b>e zezë mesnate</b>         | <i>night black</i>     |



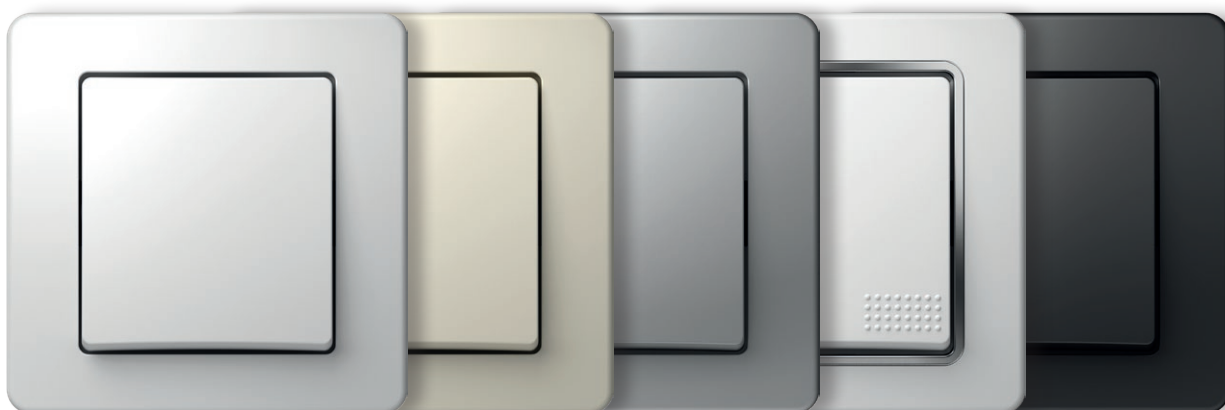

## TË THJESHTË EDHE PËR PERSONAT MË KËRKUES

Nëpërmjet planifikimit të kujdesshëm, elementet nën tension janë të mbrojtura ndaj prekjes. Fiksimi bazë i mekanizmave me kapëse fiksuese (1) lejon përforcim shtesë me vida (2). Kjo mënyrë është veçanërisht e përshtatshme për fiksimin e sigurt dhe të qëndrueshëm të prizave.

## SIMPLE FOR THE MOST DEMANDING

By careful planning elements under voltage have been protected against touching. Basic fixing of mechanisms with fixing claws (1) allows additional strengthening with screws (2). This manner is especially appropriate for safe and reliable fixing of sockets.

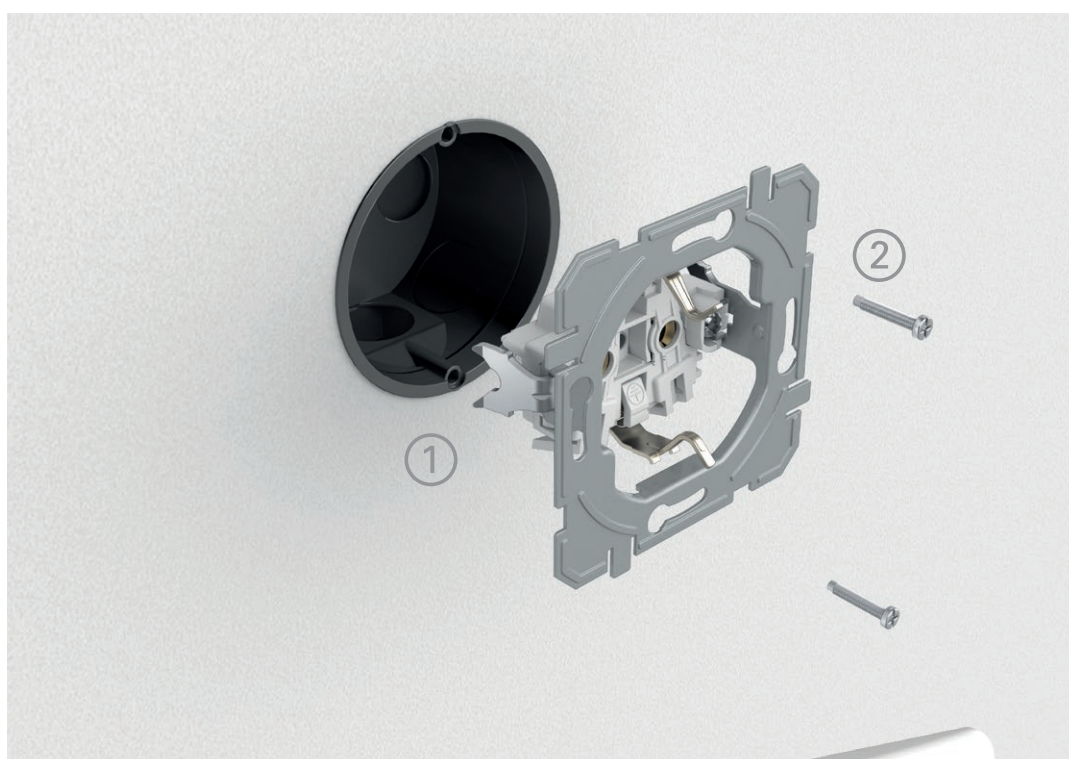

**KOMBINONI SIPAS DËSHIRËS.**

COMBINE AS YOU PLEASE.



Duke kombinuar, ju kurseni hapësirë në mur.  
Kur përballeni me një hapësirë të kufizuar,  
“vertikalisht” është vendimi më i mirë.

With combining you save space on the wall.  
When faced with a limited space, »vertically«  
is the right decision.

## INSTALIM I LEHTË

Ekonomik është një zgjidhje për sistemin e kutive të standardizuara të rrumbullakëta të instalimit. Ai mund të përdoret për instalime të thjeshta, si dhe të komplikuar, ndërtesa të reja dhe përshtatje. Sistemi karakterizohet nga kontakte për futje telash që kursejnë kohë gjatë instalimit të elementeve.

## EASY INSTALLATION

Ekonomik is a solution for the system of standardized round installations boxes. It can be used for simple as well as more demanding installations, new buildings and adaptations. The system is characterised by plug-in contacts which save time during installation of elements.

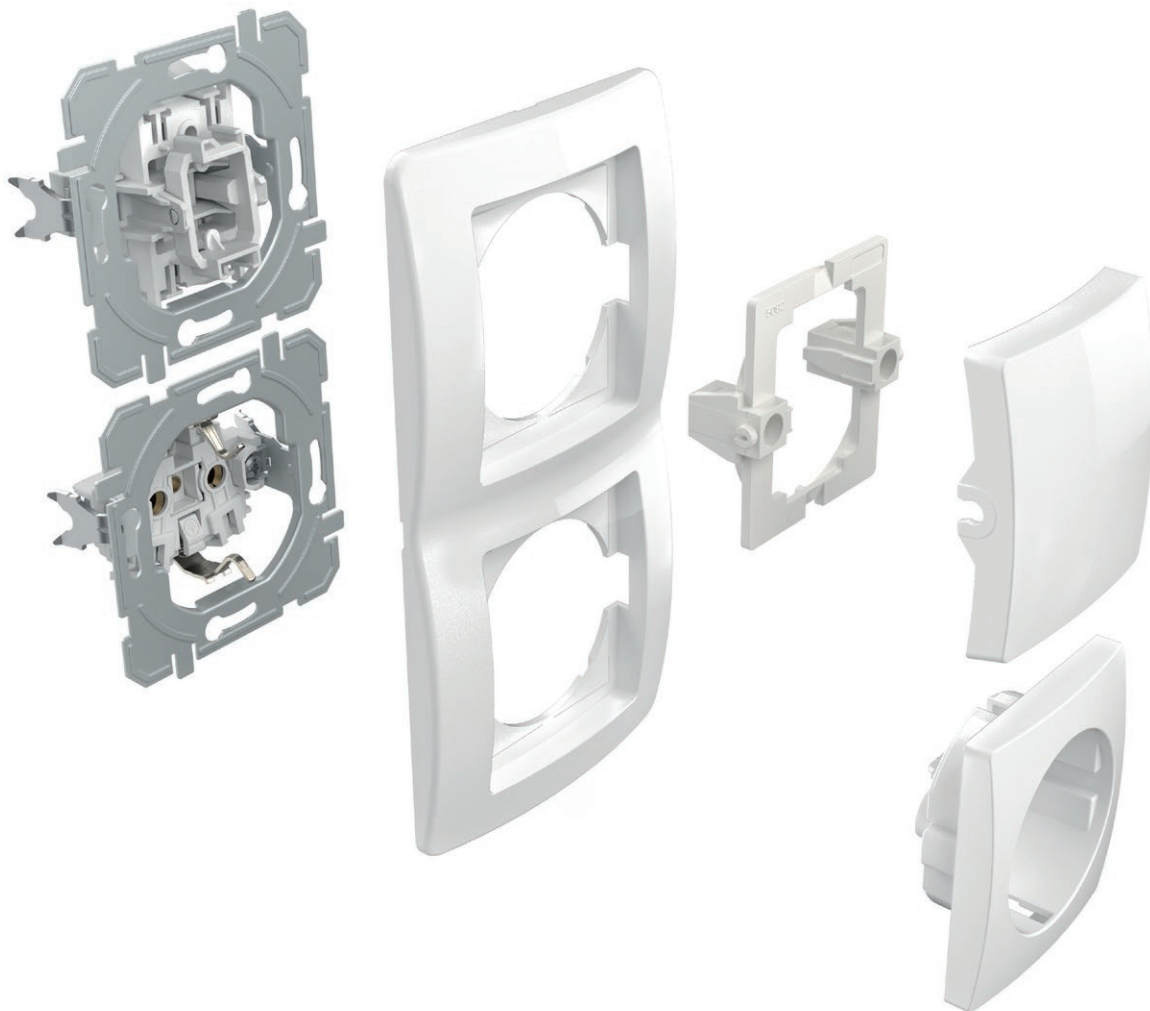



## INFORMACION I DOBISHËM

### GOOD TO KNOW



Të gjitha prizat janë të pajisura me mbyllëse sigurie që garantojnë mbrojtjen e kontakteve nën tension.

All the sockets are equipped with a safety shutters assuring the protection to live contacts.



Një ndërtim çelësi i planifikuar mirë e bën të mundur ndriçimin e thjeshtë edhe më pas.

A well-planned switch construction makes easy illumination possible also subsequently.



Kontaktet prej aliazhi argjendi garantojnë takim-stakim të sigurt.

Contacts made of silver alloy guarantee safe switching.



Kontaktet për futjen e telave mundësojnë bashkim të shpejtë dhe të sigurt të telave. Dy tela me diametër të ndryshëm mund të bashkohen me të njëjtin kontakt.

Plug-in contacts enable quick and reliable attachment of wires. Two wires of different diameters can be attached to the same contact.



Kapëset fiksuese mundësojnë fiksime më të thellë (gjithashtu përmes pllakave qeramike etj.)

Fixing claws enable deeper fixing (also through ceramic tiles, etc.)



Kutitë e instalimit me montim të lehtë do t'ju lehtësojnë punën. Gjatësitë e dhura janë të garantuara.

Easy-fitting installation boxes will make your work easier. Proper lengths are guaranteed.

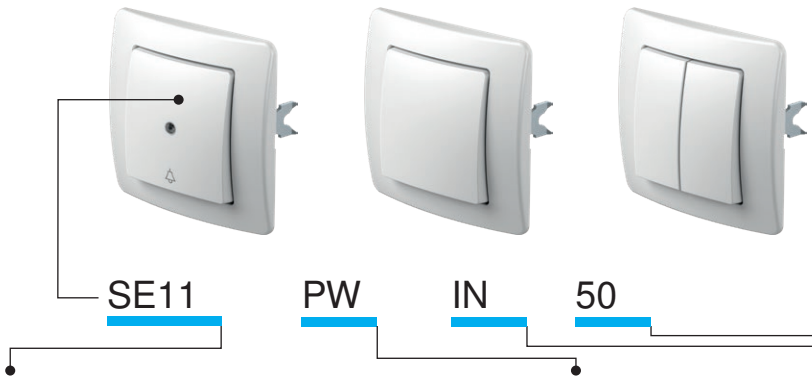

Iloji type	përshkrimi description	të dhënat teknike technical data	ngjyra colour	të dhënat opsionale 1 optional data 1	të dhënat opsionale 2 optional data 2
SE10	ÇELËS ME 1 DREJTIM SWITCH 1WAY	10AX 250V~	<input type="checkbox"/> PW e bardhë polare polar white	NT neutral neutral	50
SE11	BUTON MESHTYRJE ME 1 DREJTIM PUSH BUTTON 1WAY	10A 250V~	<input type="checkbox"/> IW e bardhë fildishi ivory white	IN treguesi indicator	51
SE22	ÇELËS 2 POLAR SWITCH 2POLE	16AX 250V~	<input type="checkbox"/> ES e argjendtë elox elox silver		03
...	...	...	<input type="checkbox"/> CO termoset i bardhë white thermostat		04
...	...	...	<input type="checkbox"/> NB e zezë mesnate night black		...

ÇELËS ME 1 DREJTIM 10 A X 250 V~

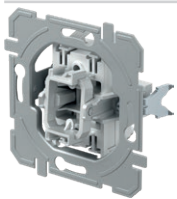

SE10

- 10 A X 250 V~, Iloji SE10
  - në përputhje me EN 60669-1
  - kontakte për futje telash 1,5-2,5 mm<sup>2</sup>
- SWITCH 1WAY 10AX 250V~
- 10AX 250V~, type SE10
  - in accordance with EN 60669-1
  - plug-in contacts 1.5-2.5mm<sup>2</sup>

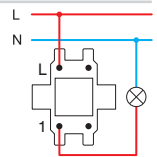

BUTON ME SHTYRJE ME 1 DREJTIM 10A 250 V~

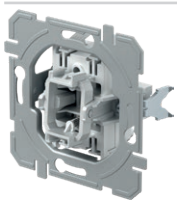

SE11

- 10A 250 V~, Iloji SE11
  - në përputhje me EN 60669-1
  - kontakte për futje telash 1,5-2,5 mm<sup>2</sup>
- PUSH BUTTON 1WAY 10A 250V~
- 10A 250V~, type SE11
  - in accordance with EN 60669-1
  - plug-in contacts 1.5-2.5mm<sup>2</sup>

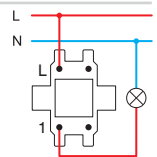

ÇELËS 2 POLAR 16 A X 250 V~

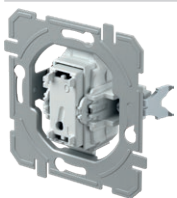

SE22

- 16 A X 250 V~, Iloji SE22
  - në përputhje me EN 60669-1
  - kontaktet e vidave 1,5-2,5 mm<sup>2</sup>
  - vetëm në kombinim me butonin TE10\_\_NT03
- SWITCH 2POLE 16AX 250V~
- 16AX 250V~, type SE22
  - in accordance with EN 60669-1
  - screw contacts 1.5-2.5mm<sup>2</sup>
  - only in combination with button TE10\_\_NT03

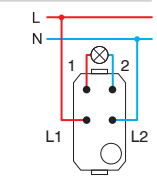
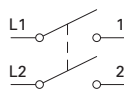

ÇELËS ME 2 POZICIONE - 1 DREJTIM 10 A X 250 V~

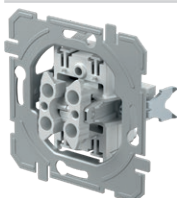

SE50

- 10 A X 250 V~, Iloji SE50
  - në përputhje me EN 60669-1
  - kontakte për futje telash 1,5-2,5 mm<sup>2</sup>
- SWITCH 2GANG-1WAY 10AX 250V~
- 10AX 250V~, type SE50
  - in accordance with EN 60669-1
  - plug-in contacts 1.5-2.5mm<sup>2</sup>

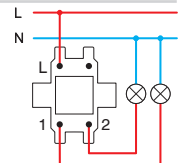
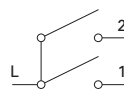

## S W I T C H E S S E

## BUTON ME SHYTPJE ME 2 POZICIONE - 1 DREJTIM 10A 250 V~

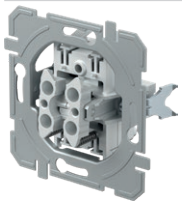

SE51

- 10 A 250 V~, Iloji SE51
- në përputhje me EN 60669-1
- kontakte për futje telash 1,5-2,5 mm<sup>2</sup>

*PUSH BUTTON 2GANG-1WAY 10A 250V~*

- 10A 250V~, type SE51
- in accordance with EN 60669-1
- plug-in contacts 1.5-2.5mm<sup>2</sup>

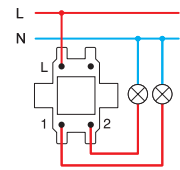
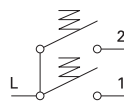

## MBYLLËSE ÇELËSI 10 A X 250 V~

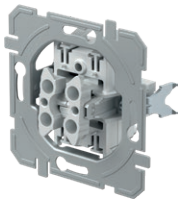

SE52

- 10 A X 250 V~, Iloji SE52
- në përputhje me EN 60669-1
- kontakte për futje telash 1,5-2,5 mm<sup>2</sup>
- me bllokim mekanik

*SWITCH SHUTTERS 10AX 250V~*

- 10AX 250V~, type SE52
- in accordance with EN 60669-1
- plug-in contacts 1.5-2.5mm<sup>2</sup>
- with mechanical interblock

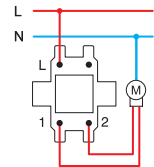
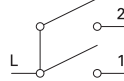

## MBYLLËSE BUTONI ME SHYTPJE 10 A 250 V~

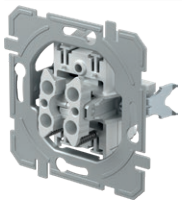

SE53

- 10A 250 V~, Iloji SE53
- në përputhje me EN 60669-1
- kontakte për futje telash 1,5-2,5 mm<sup>2</sup>
- me bllokim mekanik

*PUSH BUTTON SHUTTERS 10A 250V~*

- 10A 250V~, type SE53
- in accordance with EN 60669-1
- plug-in contacts 1.5-2.5mm<sup>2</sup>
- with mechanical interblock

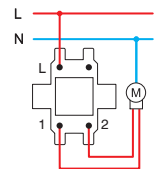
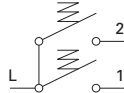

## ÇELËS ME 2 DREJTIME 10 A X 250 V~

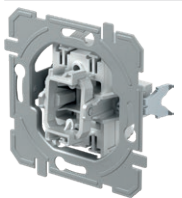

SE60

- 10 A X 250 V~, Iloji SE60
- në përputhje me EN 60669-1
- kontakte për futje telash 1,5-2,5 mm<sup>2</sup>

*SWITCH 2WAY 10AX 250V~*

- 10AX 250V~, type SE60
- in accordance with EN 60669-1
- plug-in contacts 1.5-2.5mm<sup>2</sup>

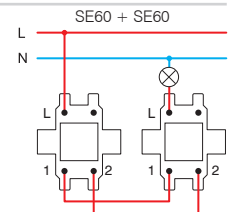
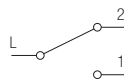

## ÇELËS DYSH ME 2 DREJTIME 10 A X 250 V~

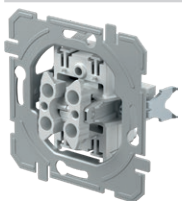

SE63

- 10 A X 250 V~, Iloji SE63
- në përputhje me EN 60669-1
- kontakte për futje telash 1,5-2,5 mm<sup>2</sup>

*SWITCH DOUBLE 2WAY 10AX 250V~*

- 10AX 250V~, type SE63
- in accordance with EN 60669-1
- plug-in contacts 1.5-2.5mm<sup>2</sup>

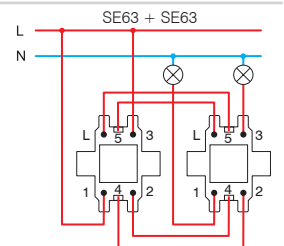

## ÇELËS NDËRMJETËS 10 A X 250 V~

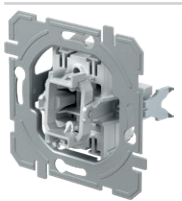

SE70

- 10 A X 250 V~, Iloji SE70
- në përputhje me EN 60669-1
- kontakte për futje telash 1,5-2,5 mm<sup>2</sup>

*SWITCH INTERMEDIATE 10AX 250V~*

- 10AX 250V~, type SE70
- in accordance with EN 60669-1
- plug-in contacts 1.5-2.5mm<sup>2</sup>

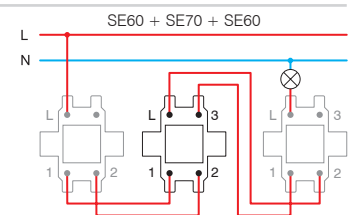

ÇELËS ME 1 DREJTIM 10 A X 250 V~



- SE10PW
- SE10IW
- SE10ES
- SE10CO
- SE10NB

- 10 A X 250 V~, Iloji SE10  
 - në përputhje me EN 60669-1  
 - kontakte për futje telash 1,5-2,5 mm<sup>2</sup>

*SWITCH 1WAY 10AX 250V~*  
 - 10AX 250V~, type SE10  
 - in accordance with EN 60669-1  
 - plug-in contacts 1.5-2.5mm<sup>2</sup>



ÇELËS ME 1 DREJTIM 10 A X 250 V~ \_\_ IN



- SE10PWIN
- SE10IWIN
- SE10ESIN
- SE10COIN
- SE10NBIN

- IN tregues  
 - 10 A X 250 V~, Iloji SE10  
 - në përputhje me EN 60669-1  
 - kontakte për futje telash 1,5-2,5 mm<sup>2</sup>

*SWITCH 1WAY 10AX 250V~ \_\_ IN*  
 - IN indicator  
 - 10AX 250V~, type SE10  
 - in accordance with EN 60669-1  
 - plug-in contacts 1.5-2.5mm<sup>2</sup>



BUTON ME SHTYPJE ME 1 DREJTIM 10A 250 V~



- SE11PW
- SE11IW
- SE11ES
- SE11CO
- SE11NB

- 10A 250 V~, Iloji SE11  
 - në përputhje me EN 60669-1  
 - kontakte për futje telash 1,5-2,5 mm<sup>2</sup>

*PUSH BUTTON 1WAY 10A 250V~*  
 - 10A 250V~, type SE11  
 - in accordance with EN 60669-1  
 - plug-in contacts 1.5-2.5mm<sup>2</sup>



BUTON ME SHTYPJE ME 1 DREJTIM 10 A 250 V~ \_\_ TI 50



- SE11PWTI50
- SE11IWTI50
- SE11ESTI50
- SE11COTI50
- SE11NBTI50

- TI 50 zile treguese+llambë neoni  
 - 10A 250 V~, Iloji SE11  
 - në përputhje me EN 60669-1  
 - kontakte për futje telash 1,5-2,5 mm<sup>2</sup>

*PUSH BUTTON 1WAY 10A 250V~ \_\_ TI 50*  
 - TI 50 indicator bell+neon lamp  
 - 10A 250V~, type SE11  
 - in accordance with EN 60669-1  
 - plug-in contacts 1.5-2.5mm<sup>2</sup>



BUTON ME SHTYPJE ME 1 DREJTIM 10 A 250 V~ \_\_ TI 51



- SE11PWTI51
- SE11IWTI51
- SE11ESTI51
- SE11COTI51
- SE11NBTI51

- TI 51 dritë treguese+llambë neoni  
 - 10A 250 V~, Iloji SE11  
 - në përputhje me EN 60669-1  
 - kontakte për futje telash 1,5-2,5 mm<sup>2</sup>

*PUSH BUTTON 1WAY 10A 250V~ \_\_ TI 51*  
 - TI 51 indicator light+neon lamp  
 - 10A 250V~, type SE11  
 - in accordance with EN 60669-1  
 - plug-in contacts 1.5-2.5mm<sup>2</sup>



BUTON ME SHTYPJE ME 1 DREJTIM 10 A 250 V~ \_\_ IL



- SE11PWIL
- SE11IWIL
- SE11ESIL
- SE11COIL
- SE11NBIL

- IL pllakë me mbishkrim  
 - 10A 250 V~, Iloji SE11  
 - në përputhje me EN 60669-1  
 - kontakte për futje telash 1,5-2,5 mm<sup>2</sup>

*PUSH BUTTON 1WAY 10A 250V~ \_\_ IL*  
 - IL inscription plate  
 - 10A 250V~, type SE11  
 - in accordance with EN 60669-1  
 - plug-in contacts 1.5-2.5mm<sup>2</sup>



ÇELËS 2 POLAR 16 A X 250 V~ \_\_ IN 03



- SE22PWIN03
- SE22IWIN03
- SE22ESIN03
- SE22NBIN03

- IN 03 neutral 0-1  
 - 16 A X 250 V~, Iloji SE22  
 - në përputhje me EN 60669-1  
 - kontaktet e vidave 1,5-2,5 mm<sup>2</sup>

*SWITCH 2POLE 16AX 250V~ \_\_ IN 03*  
 - IN 03 neutral 0-1  
 - 16AX 250V~, type SE22  
 - in accordance with EN 60669-1  
 - screw contacts 1.5-2.5mm<sup>2</sup>



## S W I T C H E S S E

	<ul style="list-style-type: none"> <li><input type="checkbox"/> SE50PW</li> <li><input type="checkbox"/> SE50IW</li> <li><input type="checkbox"/> SE50ES</li> <li><input type="checkbox"/> SE50CO</li> <li><input checked="" type="checkbox"/> SE50NB</li> </ul>	<b>ÇELËS ME 2 POZICIONE - 1 DREJTIM 10 A X 250 V~</b>	<ul style="list-style-type: none"> <li>- 10 A X 250 V~, Iloji SE50</li> <li>- në përputhje me EN 60669-1</li> <li>- kontakte për futje telash 1,5-2,5 mm<sup>2</sup></li> </ul> <p><i>SWITCH 2GANG-1WAY 10AX 250V~</i></p> <ul style="list-style-type: none"> <li>- 10AX 250V~, type SE50</li> <li>- in accordance with EN 60669-1</li> <li>- plug-in contacts 1.5-2.5mm<sup>2</sup></li> </ul>	
	<ul style="list-style-type: none"> <li><input type="checkbox"/> SE51PW</li> <li><input type="checkbox"/> SE51IW</li> <li><input type="checkbox"/> SE51ES</li> <li><input type="checkbox"/> SE51CO</li> <li><input checked="" type="checkbox"/> SE51NB</li> </ul>	<b>BUTON ME SHTYPJE ME 2 POZICIONE - 1 DREJTIM 10A 250 V~</b>	<ul style="list-style-type: none"> <li>- 10 A 250 V~, Iloji SE51</li> <li>- në përputhje me EN 60669-1</li> <li>- kontakte për futje telash 1,5-2,5 mm<sup>2</sup></li> </ul> <p><i>PUSH BUTTON 2GANG-1WAY 10A 250V~</i></p> <ul style="list-style-type: none"> <li>- 10A 250V~, type SE51</li> <li>- in accordance with EN 60669-1</li> <li>- plug-in contacts 1.5-2.5mm<sup>2</sup></li> </ul>	
	<ul style="list-style-type: none"> <li><input type="checkbox"/> SE52PWNT09</li> <li><input type="checkbox"/> SE52IWNT09</li> <li><input type="checkbox"/> SE52ESNT09</li> <li><input type="checkbox"/> SE52CONT09</li> <li><input checked="" type="checkbox"/> SE52NBNT09</li> </ul>	<b>MBYLLËSE ÇELËSI 10 A X 250 V~ __ NT 09</b>	<ul style="list-style-type: none"> <li>- NT 09 neutral lart-poshtë</li> <li>- 10 A X 250 V~, Iloji SE52</li> <li>- në përputhje me EN 60669-1</li> <li>- kontakte për futje telash 1,5-2,5 mm<sup>2</sup></li> <li>- me bllokim mekanik</li> </ul> <p><i>SWITCH SHUTTERS 10AX 250V~ __ NT 09</i></p> <ul style="list-style-type: none"> <li>- NT 09 neutral up-down</li> <li>- 10AX 250V~, type SE52</li> <li>- in accordance with EN 60669-1</li> <li>- plug-in contacts 1.5-2.5mm<sup>2</sup></li> <li>- with mechanical interblock</li> </ul>	
	<ul style="list-style-type: none"> <li><input type="checkbox"/> SE53PWNT09</li> <li><input type="checkbox"/> SE53IWNT09</li> <li><input type="checkbox"/> SE53ESNT09</li> <li><input type="checkbox"/> SE53CONT09</li> <li><input checked="" type="checkbox"/> SE53NBNT09</li> </ul>	<b>MBYLLËSE BUTONI ME SHTYPJE 10 A 250 V~ __ NT 09</b>	<ul style="list-style-type: none"> <li>- NT 09 neutral lart-poshtë</li> <li>- 10A 250 V~, Iloji SE53</li> <li>- në përputhje me EN 60669-1</li> <li>- kontakte për futje telash 1,5-2,5 mm<sup>2</sup></li> <li>- me bllokim mekanik</li> </ul> <p><i>PUSH BUTTON SHUTTERS 10A 250V~ __ NT 09</i></p> <ul style="list-style-type: none"> <li>- NT 09 neutral up-down</li> <li>- 10A 250V~, type SE53</li> <li>- in accordance with EN 60669-1</li> <li>- plug-in contacts 1.5-2.5mm<sup>2</sup></li> <li>- with mechanical interblock</li> </ul>	
	<ul style="list-style-type: none"> <li><input type="checkbox"/> SE60PW</li> <li><input type="checkbox"/> SE60IW</li> <li><input type="checkbox"/> SE60ES</li> <li><input type="checkbox"/> SE60CO</li> <li><input checked="" type="checkbox"/> SE60NB</li> </ul>	<b>ÇELËS ME 2 DREJTIME 10 A X 250 V~</b>	<ul style="list-style-type: none"> <li>- 10 A X 250 V~, Iloji SE60</li> <li>- në përputhje me EN 60669-1</li> <li>- kontakte për futje telash 1,5-2,5 mm<sup>2</sup></li> </ul> <p><i>SWITCH 2WAY 10AX 250V~</i></p> <ul style="list-style-type: none"> <li>- 10AX 250V~, type SE60</li> <li>- in accordance with EN 60669-1</li> <li>- plug-in contacts 1.5-2.5mm<sup>2</sup></li> </ul>	
	<ul style="list-style-type: none"> <li><input type="checkbox"/> SE63PW</li> <li><input type="checkbox"/> SE63IW</li> <li><input type="checkbox"/> SE63ES</li> <li><input type="checkbox"/> SE63CO</li> <li><input checked="" type="checkbox"/> SE63NB</li> </ul>	<b>ÇELËS DYSH ME 2 DREJTIME 10 A X 250 V~</b>	<ul style="list-style-type: none"> <li>- 10 A X 250 V~, Iloji SE63</li> <li>- në përputhje me EN 60669-1</li> <li>- kontakte për futje telash 1,5-2,5 mm<sup>2</sup></li> </ul> <p><i>SWITCH DOUBLE 2WAY 10AX 250V~</i></p> <ul style="list-style-type: none"> <li>- 10AX 250V~, type SE63</li> <li>- in accordance with EN 60669-1</li> <li>- plug-in contacts 1.5-2.5mm<sup>2</sup></li> </ul>	
	<ul style="list-style-type: none"> <li><input type="checkbox"/> SE70PW</li> <li><input type="checkbox"/> SE70IW</li> <li><input type="checkbox"/> SE70ES</li> <li><input type="checkbox"/> SE70CO</li> <li><input checked="" type="checkbox"/> SE70NB</li> </ul>	<b>ÇELËS NDËRMJETËS 10 A X 250 V~</b>	<ul style="list-style-type: none"> <li>- 10 A X 250 V~, Iloji SE70</li> <li>- në përputhje me EN 60669-1</li> <li>- kontakte për futje telash 1,5-2,5 mm<sup>2</sup></li> </ul> <p><i>SWITCH INTERMEDIATE 10AX 250V~</i></p> <ul style="list-style-type: none"> <li>- 10AX 250V~, type SE70</li> <li>- in accordance with EN 60669-1</li> <li>- plug-in contacts 1.5-2.5mm<sup>2</sup></li> </ul>	

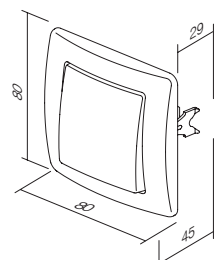
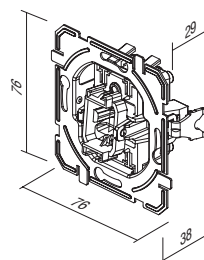



TE11

PW

NT

09

Iloji type	përshkrimi description	ngjyra colour	të dhënat opsionale 1 optional data 1	të dhënat opsionale 2 optional data 2
TE10	BUTON ME 1 POZICION BUTTON 1GANG	<input type="checkbox"/> PW e bardhë polare polar white	NT neutral neutral	50
TE11	BUTON ME 2 POZICIONE BUTTON 2GANG	<input type="checkbox"/> IW e bardhë fildishi ivory white	IN treguesi indicator	51
...	...	<input type="checkbox"/> ES e argjendtë elox elox silver		03
...	...	<input type="checkbox"/> CO termoset i bardhë white thermoset		04
...	...	<input type="checkbox"/> NB e zezë mesnate night black		

BUTON ME 1 POZICION



- TE10PW
- TE10IW
- TE10ES
- TE10CO
- TE10NB

- buton bashkë me mbajtësen

*BUTTON 1GANG*

- button together with carrier



TREGUES BUTONI

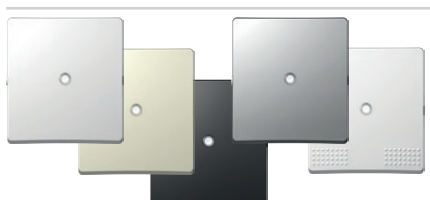

- TE10PWIN
- TE10IWIN
- TE10ESIN
- TE10COIN
- TE10NBIN

- buton bashkë me mbajtësen

*BUTTON INDICATOR*

- button together with carrier



BUTON ME KAPAK ME MBISHKRIM

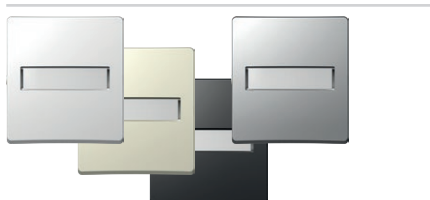

- TE13PWIL
- TE13IWIL
- TE13ESIL
- TE13NBIL

- buton bashkë me mbajtësen, me pllakë me mbishkrim

*BUTTON WITH INSCRIPTION PLATE*

- button together with carrier, with inscription plate



BUTON ME 2 POZICIONE



- TE11PW
- TE11IW
- TE11ES
- TE11CO
- TE11NB

- butoni me 2 pozicione bashkë me mbajtësen

*BUTTON 2GANG*

- button 2gang together with carrier

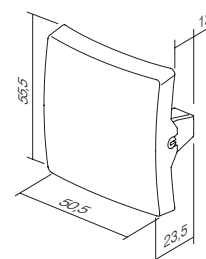
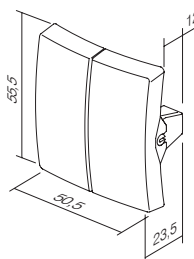

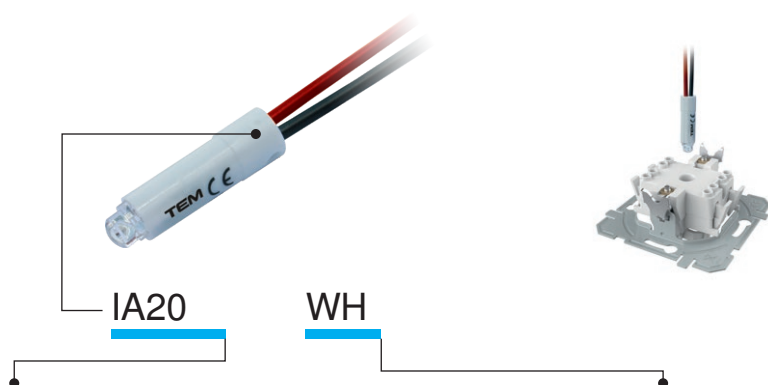

Iloji type	përshkrimi description	të dhënat teknike technical data	ngjyra colour
IA10	LLAMBË NEONI NEON LAMP	230V~ 0,34W	<input type="checkbox"/> WH e bardhë white
IA20	LLAMBË LED LED LAMP	230V~ 0,40W	<input checked="" type="checkbox"/> BL blu blue
IA21	LLAMBË LED LED LAMP	24V AC/DC 0,20W	<input checked="" type="checkbox"/> RD e kuqe red
·	·	·	<input checked="" type="checkbox"/> GR e gjelbër green
·	·	·	<input checked="" type="checkbox"/> OR portokalli orange

## LLAMBË NEONI 230 V~ 0,34 W

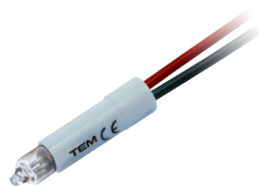

 IA10OR

- si tregues, për ndriçim ose ndriçim konstant të çelësit
- në kombinim me butonin me tregues

## NEON LAMP 230V~ 0,34W

- for indication, illumination or constant illumination of switch
- in combination with button with indicator

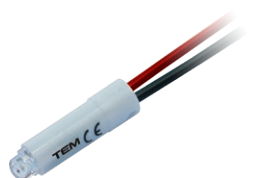
## LLAMBË LED 230 V AC/DC 0,40 W



 IA20WH  
 IA20GR  
 IA20RD  
 IA20BL

- si tregues, për ndriçim ose ndriçim konstant të çelësit
- në kombinim me butonin me tregues

## LED LAMP 230V AC/DC 0,40W

- for indication, illumination or constant illumination of switch
- in combination with button with indicator

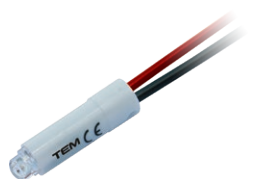
## LLAMBË LED 24V AC/DC 0,20W



 IA21WH  
 IA21RD

- si tregues, për ndriçim ose ndriçim konstant të çelësit
- në kombinim me butonin me tregues

## LED LAMP 24V AC/DC 0,20W

- for indication, illumination or constant illumination of switch
- in combination with button with indicator

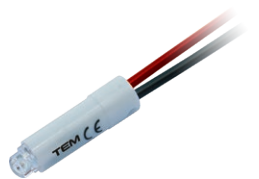
## LLAMBË LED 12V AC/DC 0,10W

 IA22WH  
 IA22RD

- si tregues, për ndriçim ose ndriçim konstant të çelësit
- në kombinim me butonin me tregues

## LED LAMP 12V AC/DC 0,10W

- for indication, illumination or constant illumination of switch
- in combination with button with indicator

Treguesi /  
Indication

\* Ndrëçimi /  
Illumination

Ndrëçim konstant /  
Illumination always on

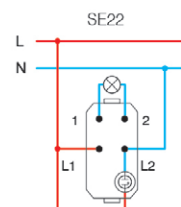
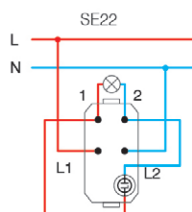
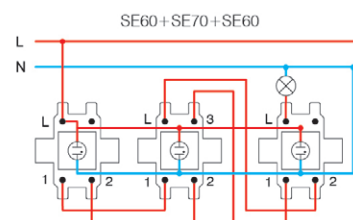
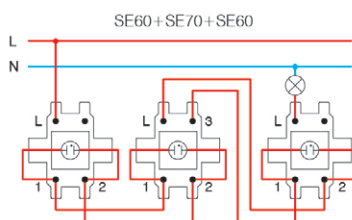
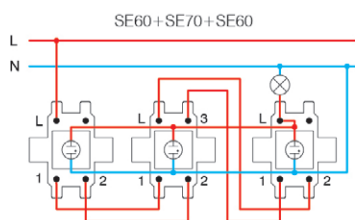
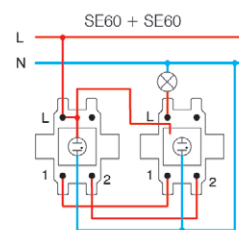
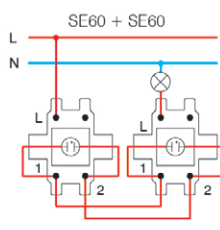
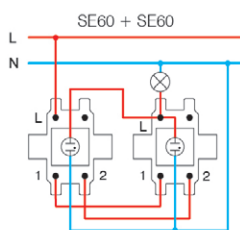
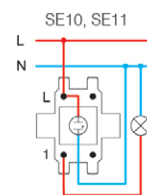
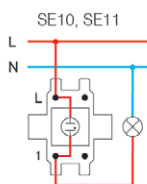
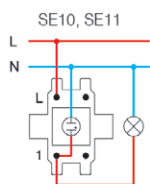

\* lidhjet nuk janë të përshtatshme për llambat që kursejnë energji (CFL, LED) /  
the connections are not suitable for energy-saving bulbs (CFL, LED)

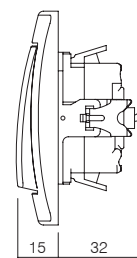



## S O C K E T S V E

**VE11**      **PT**      **XO**      **KS**

lloji type	përshkrimi description	të dhënat teknike technical data	të dhënat opsionale 1 optional data 1	të dhënat opsionale 2 optional data 2
VE10	PRIZË SCHUKO SOCKET SCHUKO	2P+E 16A 250V~	XO pa kapak mbulues without cover plate	KS kontaktet me rrymën të mbuluara shuttered live contacts
VE11	PRIZË SCHUKO+KAPAK SOCKET SCHUKO+COVER	2P+E 16A 250V~		
VE12	PRIZË SCHUKO SOCKET SCHUKO	2P+E 16A 250V~ BV	KS kontaktet me rrymën të mbuluara shuttered live contacts	
⋮	⋮	⋮		

ngjyra  
colour

<input type="checkbox"/> PW e bardhë polare polar white	<input checked="" type="checkbox"/> PT e bardhë+transparente white+transparent	<input type="checkbox"/> PP e bardhë+e bardhë white+white
<input checked="" type="checkbox"/> IW e bardhë fildishi ivory white	<input checked="" type="checkbox"/> IT e fildishtë+transparente ivory+transparent	<input checked="" type="checkbox"/> II e fildishtë+e fildishtë ivory+ivory
<input type="checkbox"/> ES e argjendtë elox elox silver	<input checked="" type="checkbox"/> ST e argjendtë+transparente silver+transparent	<input type="checkbox"/> SS e argjendtë+e argjendtë silver+silver
<input type="checkbox"/> CO termoset i bardhë white thermoset	<input type="checkbox"/> CT e bardhë+transparente white+transparent	<input checked="" type="checkbox"/> BB e zezë+e zezë black+black
<input checked="" type="checkbox"/> NB e zezë mesnate night black	<input checked="" type="checkbox"/> BT e zezë+transparente black+transparent	<input checked="" type="checkbox"/> RR e kuqe+e kuqe red+red
<input checked="" type="checkbox"/> RD e kuqe red	<input checked="" type="checkbox"/> RT e kuqe+transparente red+transparent	<input checked="" type="checkbox"/> GG e gjelbër+e gjelbër green+green
<input checked="" type="checkbox"/> GR e gjelbër green	<input checked="" type="checkbox"/> GT e gjelbër+transparente green+transparent	<input checked="" type="checkbox"/> OO portokalli+portokalli orange+orange
<input checked="" type="checkbox"/> OR portokalli orange	<input checked="" type="checkbox"/> OT portokalli+transparente orange+transparent	



schuko - në përputhje me EN 60884-1, CEE7 (fleta e standardit III)

Franceze - në përputhje me NF C 61-314 (fleta e standardit V)

schuko - in accordance with EN 60884-1, CEE7 (standard sheet III)

French - in accordance with NF C 61-314 (standard sheet V)

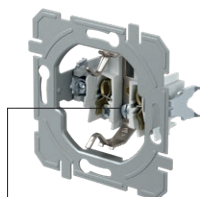

kontaktet e vidave  
screw contacts

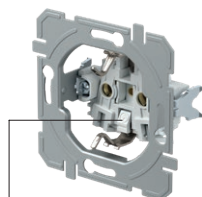

kontaktet për futje telash BV  
BV plug-in contacts

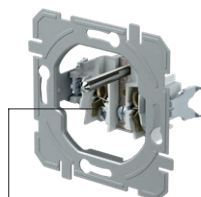

kontaktet e vidave  
screw contacts

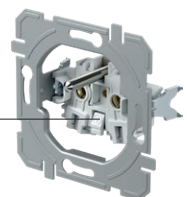

kontaktet për futje telash BV  
BV plug-in contacts

PRIZË SCHUKO 2P+E 16 A 250 V~ \_\_ XO

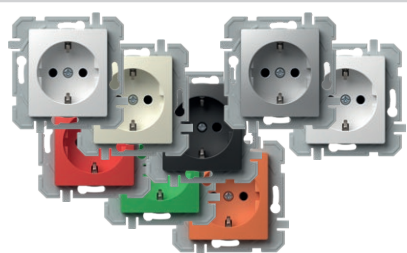

- VE10PWXO
- VE10IWXO
- VE10ESXO
- VE10COXO
- VE10NBXO
- VE10RDXO
- VE10GRXO
- VE10ORXO

- kontaktet e vidave 1,5-2,5 mm<sup>2</sup>
- XO pa kapak mbulues
- 2P+E schuko
- 16 A 250 V~, Iloji VE10

SOCKET SCHUKO 2P+E 16A 250V~ \_\_ XO

- screw contacts 1.5-2.5mm<sup>2</sup>
- XO without surround
- 2P+E schuko
- 16A 250V~, type VE10



PRIZË SCHUKO+KAPAK 2P+E 16 A 250 V~ \_\_ XO



- VE11PTXO
- VE11ITXO
- VE11STXO
- VE11BTXO

- kontaktet e vidave 1,5-2,5 mm<sup>2</sup>
- XO pa kapak mbulues
- 2P+E schuko+kapak
- 16 A 250 V~, Iloji VE11

SOCKET SCHUKO+COVER 2P+E 16A 250V~ \_\_ XO

- screw contacts 1.5-2.5mm<sup>2</sup>
- XO without surround
- 2P+E schuko+cover
- 16A 250V~, type VE11



PRIZË SCHUKO 2P+E 16 A 250 V~ BV \_\_ XO

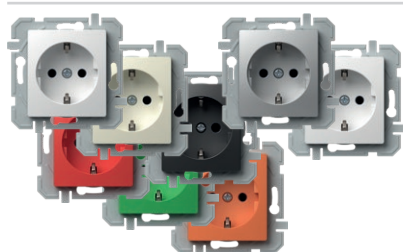

- VE12PWXO
- VE12IWXO
- VE12ESXO
- VE12COXO
- VE12NBXO
- VE12RDXO
- VE12GRXO
- VE12ORXO

- BV kontakte për futje telash 1,5-2,5 mm<sup>2</sup>
- XO pa kapak mbulues
- 2P+E schuko
- 16 A 250 V~, Iloji VE12

SOCKET SCHUKO 2P+E 16A 250V~ BV \_\_ XO

- BV plug-in contacts 1.5-2.5mm<sup>2</sup>
- XO without surround
- 2P+E schuko
- 16A 250V~, type VE12



PRIZË SCHUKO+KAPAK 2P+E 16 A 250 V~ BV \_\_ XO



- VE13PTXO
- VE13ITXO
- VE13STXO
- VE13BTXO
- VE13PPXO

- BV kontakte për futje telash 1,5-2,5 mm<sup>2</sup>
- XO pa kapak mbulues
- 2P+E schuko+kapak
- 16 A 250 V~, Iloji VE13

SOCKET SCHUKO+COVER 2P+E 16A 250V~ BV \_\_ XO

- BV plug-in contacts 1.5-2.5mm<sup>2</sup>
- XO without surround
- 2P+E schuko+cover
- 16A 250V~, type VE13



PRIZË SCHUKO 2P+E 16 A 250 V~



- VE10PW
- VE10IW
- VE10ES
- VE10CO
- VE10NB

- kontaktet e vidave 1,5-2,5 mm<sup>2</sup>
- 2P+E schuko
- 16 A 250 V~, Iloji VE10

SOCKET SCHUKO 2P+E 16A 250V~

- screw contacts 1.5-2.5mm<sup>2</sup>
- 2P+E schuko
- 16A 250V~, type VE10



PRIZË SCHUKO+KAPAK 2P+E 16 A 250 V~



- VE11PT
- VE11IT
- VE11ST
- VE11CT
- VE11BT

- kontaktet e vidave 1,5-2,5 mm<sup>2</sup>
- 2P+E schuko+kapak
- 16 A 250 V~, Iloji VE11

SOCKET SCHUKO+COVER 2P+E 16A 250V~

- screw contacts 1.5-2.5mm<sup>2</sup>
- 2P+E schuko+cover
- 16A 250V~, type VE11



PRIZË SCHUKO 2P+E 16 A 250 V~ BV



- VE12PW
- VE12IW
- VE12ES
- VE12CO
- VE12NB

- BV kontakte për futje telash 1,5-2,5 mm<sup>2</sup>
- 2P+E schuko
- 16 A 250 V~, Iloji VE12

SOCKET SCHUKO 2P+E 16A 250V~ BV

- BV plug-in contacts 1.5-2.5mm<sup>2</sup>
- 2P+E schuko
- 16A 250V~, type VE12



PRIZË SCHUKO+KAPAK 2P+E 16 A 250 V~ BV



- VE13PT
- VE13IT
- VE13ST
- VE13CT
- VE13BT

- BV kontakte për futje telash 1,5-2,5 mm<sup>2</sup>
- 2P+E schuko+kapak
- 16 A 250 V~, Iloji VE13

SOCKET SCHUKO+COVER 2P+E 16A 250V~ BV

- BV plug-in contacts 1.5-2.5mm<sup>2</sup>
- 2P+E schuko+cover
- 16A 250V~, type VE13



## S O C K E T S V E

## PRIZË FRANCEZE 2P+E 16 A 250 V~ \_\_ XO

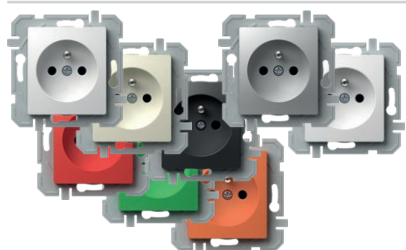

- VE40PWXO
- VE40IWXO
- VE40ESXO
- VE40COXO
- VE40NBXO
- VE40RDXO
- VE40GRXO
- VE40ORXO

- kontaktet e vidave 1,5-2,5 mm<sup>2</sup>
- XO pa kapak mbulues
- 2P+E Franceze
- 16 A 250 V~, lloji VE40

## SOCKET FRENCH 2P+E 16A 250V~ \_\_ XO

- screw contacts 1.5-2.5mm<sup>2</sup>
- XO without surround
- 2P+E French
- 16A 250V~, type VE40



## PRIZË FRANCEZE+KAPAK 2P+E 16 A 250 V~ \_\_ XO



- VE41PTXO
- VE41ITXO
- VE41STXO
- VE41PTXO
- VE41BTXO
- VE41PPXO

- kontaktet e vidave 1,5-2,5 mm<sup>2</sup>
- XO pa kapak mbulues
- 2P+E Franceze+kapak
- 16 A 250 V~, lloji VE41

## SOCKET FRENCH+COVER 2P+E 16A 250V~ \_\_ XO

- screw contacts 1.5-2.5mm<sup>2</sup>
- XO without surround
- 2P+E French+cover
- 16A 250V~, type VE41



## PRIZË FRANCEZE 2P+E 16 A 250 V~ BV \_\_ XO

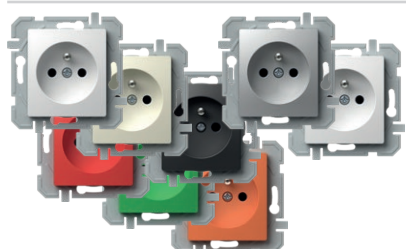

- VE42PWXO
- VE42IWXO
- VE42ESXO
- VE42COXO
- VE42NBXO
- VE42RDXO
- VE42GRXO
- VE42ORXO

- BV kontakte për futje telash 1,5-2,5 mm<sup>2</sup>
- XO pa kapak mbulues
- 2P+E Franceze
- 16 A 250 V~, lloji VE42

## SOCKET FRENCH 2P+E 16A 250V~ BV \_\_ XO

- BV plug-in contacts 1.5-2.5mm<sup>2</sup>
- XO without surround
- 2P+E French
- 16A 250V~, type VE42



## PRIZË FRANCEZE+KAPAK 2P+E 16 A 250 V~ BV \_\_ XO

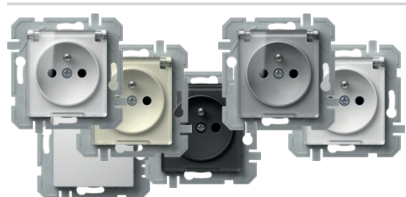

- VE43PTXO
- VE43ITXO
- VE43STXO
- VE43PTXO
- VE43BTXO
- VE43PPXO

- BV kontakte për futje telash 1,5-2,5 mm<sup>2</sup>
- XO pa kapak mbulues
- 2P+E Franceze+kapak
- 16 A 250 V~, lloji VE43

## SOCKET FRENCH+COVER 2P+E 16A 250V~ BV \_\_ XO

- BV plug-in contacts 1.5-2.5mm<sup>2</sup>
- XO without surround
- 2P+E French+cover
- 16A 250V~, type VE43



## PRIZË FRANCEZE 2P+E 16 A 250 V~



- VE40PW
- VE40IW
- VE40ES
- VE40CO
- VE40NB

- kontaktet e vidave 1,5-2,5 mm<sup>2</sup>
- 2P+E Franceze
- 16 A 250 V~, lloji VE40

## SOCKET FRENCH 2P+E 16A 250V~

- screw contacts 1.5-2.5mm<sup>2</sup>
- 2P+E French
- 16A 250V~, type VE40



## PRIZË FRANCEZE+KAPAK 2P+E 16 A 250 V~



- VE41PT
- VE41IT
- VE41BT
- VE41ST

- kontaktet e vidave 1,5-2,5 mm<sup>2</sup>
- 2P+E Franceze+kapak
- 16 A 250 V~, lloji VE41

## SOCKET FRENCH+COVER 2P+E 16A 250V~

- screw contacts 1.5-2.5mm<sup>2</sup>
- 2P+E French+cover
- 16A 250V~, type VE41



## PRIZË FRANCEZE 2P+E 16 A 250 V~ BV



- VE42PW
- VE42IW
- VE42ES
- VE42CO
- VE42NB

- BV kontakte për futje telash 1,5-2,5 mm<sup>2</sup>
- 2P+E Franceze
- 16 A 250 V~, lloji VE42

## SOCKET FRENCH 2P+E 16A 250V~ BV

- BV plug-in contacts 1.5-2.5mm<sup>2</sup>
- 2P+E French
- 16A 250V~, type VE42



## PRIZË FRANCEZE+KAPAK 2P+E 16 A 250 V~ BV



- VE43PT
- VE43IT
- VE43BT
- VE43ST

- BV kontakte për futje telash 1,5-2,5 mm<sup>2</sup>
- 2P+E Franceze+kapak
- 16 A 250 V~, lloji VE43

## SOCKET FRENCH+COVER 2P+E 16A 250V~ BV

- BV plug-in contacts 1.5-2.5mm<sup>2</sup>
- 2P+E French+cover
- 16A 250V~, type VE43



PRIZË SCHUKO DYSHE 2P+E 16 A 250 V~



- VE16PWKS
- VE16WKS
- VE16ESKS
- VE16NBKS

- 2P+E schuko dyshe
- 16 A 250 V~, lloji VE16
- në përputhje me IEC 60884-1, CEE7
- kontaktet e vidave 1,5-2,5 mm<sup>2</sup>
- kontaktet KS me rrymën të mbuluara

SOCKET SCHUKO DOUBLE 2P+E 16A 250V~

- 2P+E schuko double
- 16A 250V~, type VE16
- in accordance with IEC 60884-1, CEE7
- screw contacts 1.5-2.5 mm<sup>2</sup>
- KS shuttered live contacts



PRIZË FRANCEZE DYSHE 2P+E 16 A 250 V~



- VE46PWKS
- VE46WKS
- VE46ESKS
- VE46NBKS

- 2P+E franceze dyshe
- 16 A 250 V~, lloji VE46
- në përputhje me IEC 60884-1, CEE7; NF C 61-314, CSN 33 2318; PN-E 93201
- kontaktet e vidave 1,5-2,5 mm<sup>2</sup>
- kontaktet KS me rrymën të mbuluara

SOCKET FRENCH DOUBLE 2P+E 16A 250V~

- 2P+E French double
- 16A 250V~, type VE46
- in accordance with IEC 60884-1, CEE7; NF C 61-314, CSN 33 2318; PN-E 93201
- screw contacts 1.5-2.5 mm<sup>2</sup>
- KS shuttered live contacts



PRIZË 2P 16 A 250 V~

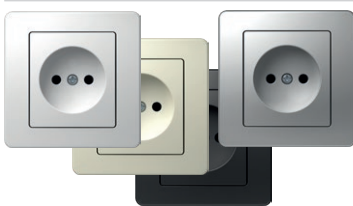

- VE30PW
- VE30IW
- VE30ES
- VE30NB

- 2P pa kontakt për tokëzimin
- 16 A 250 V~
- në përputhje me EN 60884-1, CEE7 (fleta e standardit I)
- kontaktet e vidave 1,5-2,5 mm<sup>2</sup>

SOCKET 2P 16A 250V~

- 2P without earthing contact
- 16A 250V~
- in accordance with EN 60884-1, CEE7 (standard sheet I)
- screw contacts 1.5-2.5mm<sup>2</sup>

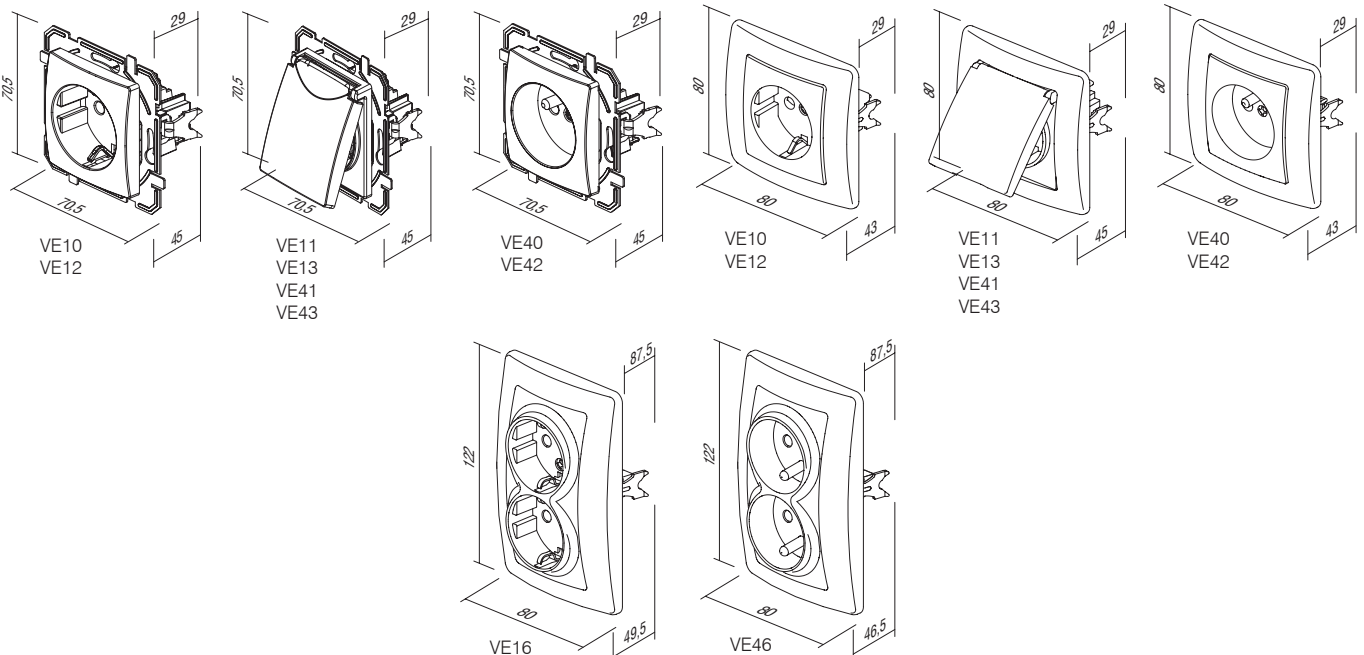



KE37

PW

Iloji type	përshkrimi description	të dhënat teknike technical data	ngjyra colour
KE11	PRIZË TV-R ME KAPAK FUNDOR SOCKET TV-R END-LINE	1dB	<input type="checkbox"/> PW e bardhë polare polar white
KE12	PRIZË TV-R KALUESE SOCKET TV-R THROUGHPASS	10dB	<input type="checkbox"/> IW e bardhë fildishi ivory white
KE16	PRIZË SAT-TV-R ME KAPAK FUNDOR SOCKET SAT-TV-R END-LINE	3dB	<input type="checkbox"/> ES e argjendtë elox elox silver
⋮	⋮	⋮	<input type="checkbox"/> CO termoset i bardhë white thermoset
⋮	⋮	⋮	<input type="checkbox"/> NB e zezë mesnate night black

## PRIZË TV-R ME KAPAK FUNDOR 1dB



KE11

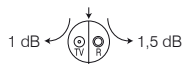

- TV-R me kapak fundor
- gama e frekuencës 5-862MHz
- reduktimi: R-1.5dB, TV-1dB
- në përputhje me EN 50083-1
- kontaktet e vidave

## SOCKET TV-R END-LINE 1dB

- TV-R end-line
- frequency range 5-862MHz
- reduction: R-1.5dB, TV-1dB
- in accordance with EN 50083-1
- screw contacts

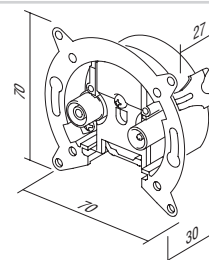

## PRIZË TV-R KALUESE 10dB



KE12

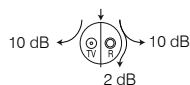

- TV-R kaluese
- gama e frekuencës 5-862MHz
- reduktimi: R-10dB, TV-10dB, kaluese-2dB
- në përputhje me EN 50083-1
- kontaktet e vidave

## SOCKET TV-R THROUGHPASS 10dB

- TV-R throughpass
- frequency range 5-862MHz
- reduction: R-10dB, TV-10dB, through-2dB
- in accordance with EN 50083-1
- screw contacts

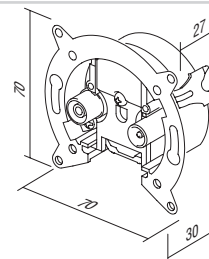

## PRIZË SAT-TV-R ME KAPAK FUNDOR 3dB



KE16

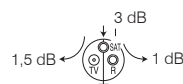

- SAT-TV-R me kapak fundor
- gama e frekuencës 5-2400MHz
- reduktimi: R-1dB, TV-1.5dB, SAT-3dB
- për montim në kuti të rumbullakët Ø60 me kthetra ose vida
- në përputhje me EN 50083-1
- kontaktet e vidave

## SOCKET SAT-TV-R END-LINE 3dB

- SAT-TV-R end-line
- frequency range 5-2400MHz
- reduction: R-1dB, TV-1.5dB, SAT-3dB
- for mounting in round box Ø60 with claws or screws
- in accordance with EN 50083-1
- screw contacts

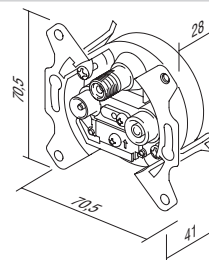

## PRIZË TEL KS RJ11 6/4

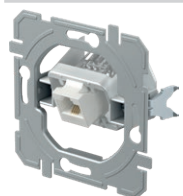

KE36

- standard fiksues trapez KS
- RJ11 6/4
- në përputhje me IEC 60603-7

## SOCKET TEL KS RJ11 6/4

- KS keystone fixing standard
- RJ11 6/4
- in accordance with IEC 60603-7

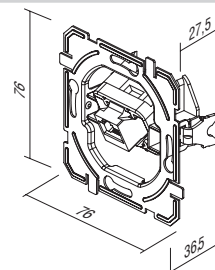

	KE37	<b>PRIZË CAT5e KS RJ45 8/8</b> - standard fiksues trapez KS - CAT5e, RJ45 8/8 - në përputhje me IEC 60603-7  <i>SOCKET CAT5e KS RJ45 8/8</i> - KS keystone fixing standard - CAT5e, RJ45 8/8 - in accordance with IEC 60603-7	
	KE40	<b>PRIZË CAT6s KS RJ45 8/8 SLIM</b> - standard fiksues trapez KS - CAT6s, RJ45 8/8 - në përputhje me IEC 60603-7  <i>SOCKET CAT6s KS RJ45 8/8 SLIM</i> - KS keystone fixing standard - CAT6s, RJ45 8/8 - in accordance with IEC 60603-7	
	KE38	<b>PRIZË TEL KS DYSHE 2x RJ11 6/4</b> - standard fiksues trapez KS - 2x RJ11 6/4 - në përputhje me IEC 60603-7  <i>SOCKET TEL KS DOUBLE 2x RJ11 6/4</i> - KS keystone fixing standard - 2x RJ11 6/4 - in accordance with IEC 60603-7	
	KE39	<b>PRIZË CAT5e KS DYSHE 2x RJ45 8/8</b> - standard fiksues trapez KS - 2x CAT5e, RJ45 8/8 - në përputhje me IEC 60603-7  <i>SOCKET CAT5e KS DOUBLE 2x RJ45 8/8</i> - KS keystone fixing standard - 2x CAT5e, RJ45 8/8 - in accordance with IEC 60603-7	
	KE41	<b>PRIZË CAT6s KS DYSHE 2x RJ45 8/8 SLIM</b> - standard fiksues trapez KS - 2x CAT6s, RJ45 8/8 - në përputhje me IEC 60603-7  <i>SOCKET CAT6s KS DOUBLE 2x RJ45 8/8 SLIM</i> - KS keystone fixing standard - 2x CAT6s, RJ45 8/8 - in accordance with IEC 60603-7	
	KE45	<b>PËRSHTATËS KS NJËSH</b> - standard fiksues trapez KS - njësh - AMP, Avaya, Brandrex, FMT, Mfico, Tyco, ... - moduli i komunikimit nuk përfshihet  <i>ADAPTER KS SINGLE</i> - KS keystone fixing standard - single - AMP, Avaya, Brandrex, FMT, Mfico, Tyco, ... - communication module not included	

## PËRSHTATËS KS DYSH

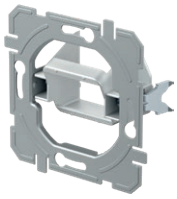

KE46

- standard fiksues trapez KS - dysh
- AMP, Tyco, ...
- moduli i komunikimit nuk përfshihet

*ADAPTER KS DOUBLE*

- KS keystone fixing standard - double
- AMP, Tyco, ...
- communication module not included

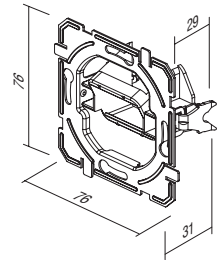

## PËRSHTATËS PD DYSH



KE47

- standard fiksues PD Panduit Mini-COM - dysh
- moduli i komunikimit nuk përfshihet

*ADAPTER PD DOUBLE*

- PD Panduit Mini-COM fixing standard - double
- communication module not included

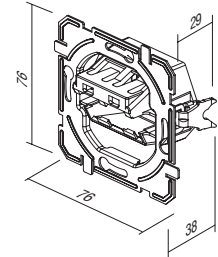



- KE10PW
- KE10IW
- KE10ES
- KE10CO
- KE10NB

**PRIZË TV BAZË 0dB**

- TV bazë
- reduktim 0dB
- lidhje e pasme – F standarde

**SOCKET TV BASIC 0dB**

- TV basic
- reduction 0dB
- back connector – F standard



- KE11PW
- KE11IW
- KE11ES
- KE11CO
- KE11NB

**PRIZË TV-R ME KAPAK FUNDOR 1dB**

- TV-R me kapak fundor
- gama e frekuencës 5÷862 MHz
- reduktimi: R-1.5dB, TV-1dB
- në përputhje me EN 50083-1
- kontaktet e vidave

**SOCKET TV-R END-LINE 1dB**

- TV-R end-line
- frequency range 5÷862 MHz
- reduction: R-1.5dB, TV-1dB
- in accordance with EN 50083-1
- screw contact



- KE12PW
- KE12IW
- KE12ES
- KE12CO
- KE12NB

**PRIZË TV-R KALUESE 10dB**

- TV-R kaluese
- gama e frekuencës 5÷862 MHz
- reduktimi: R-10dB, TV-10dB, kaluese-2dB
- në përputhje me EN 50083-1
- kontaktet e vidave

**SOCKET TV-R TROUGH-PASS 10dB**

- TV-R troughpass
- frequency range 5÷862 MHz
- reduction: R-10dB, TV-10dB, trough-2dB
- in accordance with EN 50083-1
- screw contacts



- KE16PW
- KE16IW
- KE16ES
- KE16CO
- KE16NB

**PRIZË SAT-TV-R ME KAPAK FUNDOR 3dB**

- SAT-TV-R me kapak fundor
- gama e frekuencës 5÷2400 MHz
- reduktimi: R-1dB, TV-1.5dB, SAT-3dB
- në përputhje me EN 50083-1
- kontaktet e vidave

**SOCKET SAT-TV-R END-LINE 3dB**

- SAT-TV-R end-line
- frequency range 5÷2400 MHz
- reduction: R-1dB, TV-1.5dB, SAT-3dB
- in accordance with EN 50083-1
- screw contacts



- KE22PW
- KE22IW
- KE22ES
- KE22CO
- KE22NB

**PRIZË AUDIO 2xRCA**

- audio 2xRCA
- lidhje me saldime e kablllos

**SOCKET AUDIO 2xRCA**

- audio 2xRCA
- soldering connection of cable



- KE23PW
- KE23IW
- KE23ES
- KE23CO
- KE23NB

**PRIZË AUDIO ALTOPARLANTË**

- audio 2x Ø4mm
- për të mbajtur telin e altoparlantit, spinë banane Ø4 mm ose maç
- lidhje me ngjitje e kablllos në pjesën e pasme

**SOCKET AUDIO LOUDSPEAKERS**

- audio 2x Ø4mm
- to accommodate speaker wire, banana plug Ø4mm or spades
- soldering connection of cable at the back side

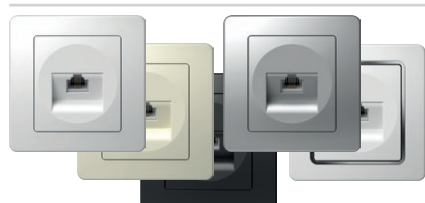

- KE36PW
- KE36IW
- KE36ES
- KE36CO
- KE36NB

**PRIZË TEL KS RJ11 6/4**

- standard fiksues trapez KS
- RJ11 6/4
- në përputhje me IEC 60603-7

**SOCKET TEL KS RJ11 6/4**

- KS keystone fixing standard
- RJ11 6/4
- in accordance with IEC 60603-7





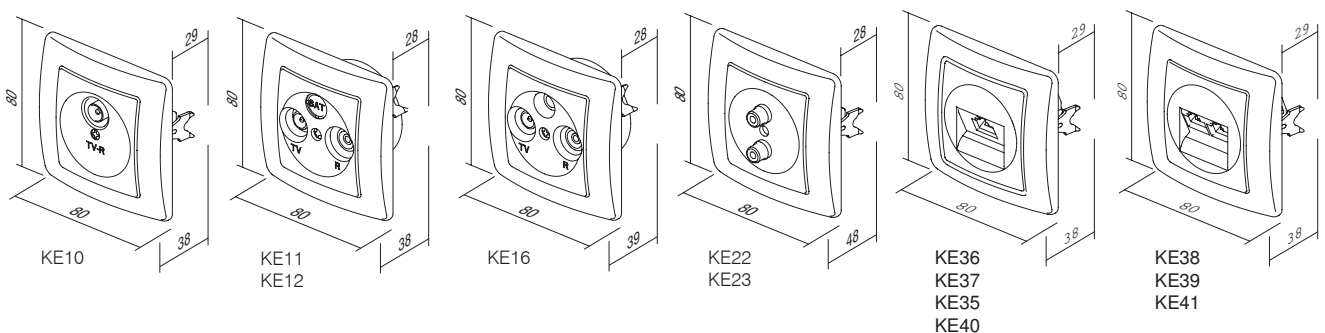
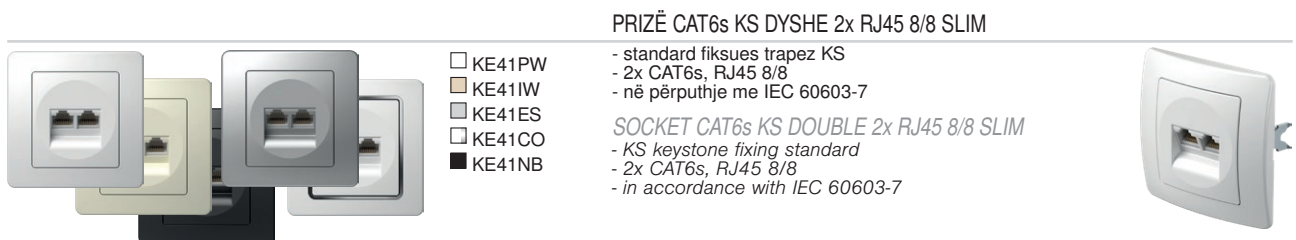
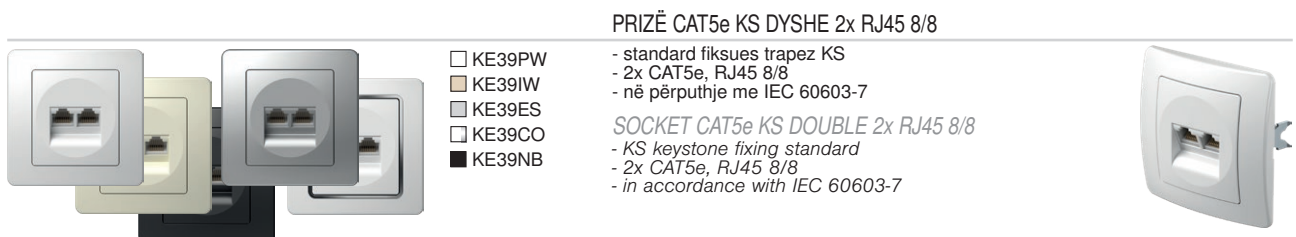
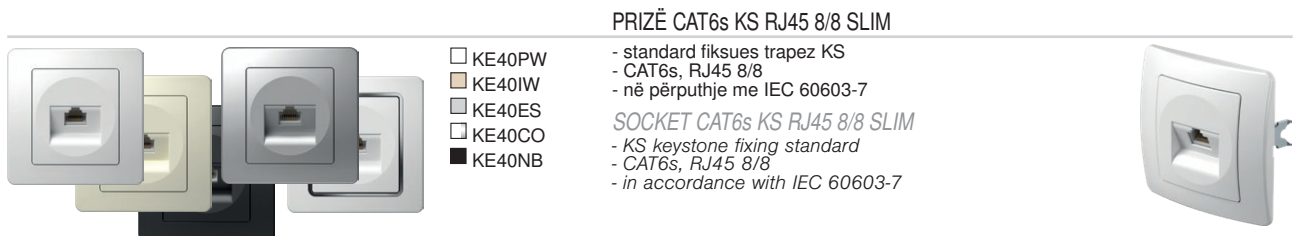
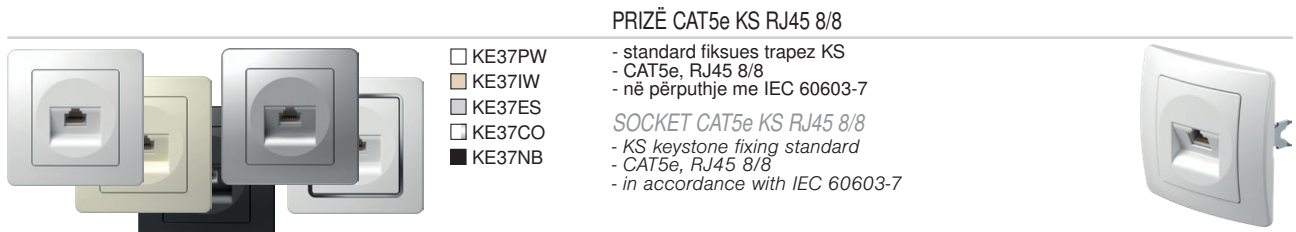

# K A P A K P Ë R K O M U N I K I M E T K E

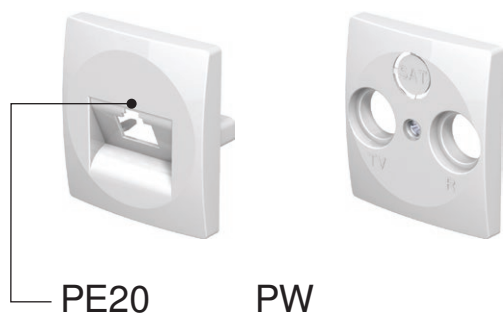

lloji type	përshkrimi description	të dhënat teknike technical data	ngjyra colour
PE10	KAPAK TV-R COVER TV-R	2P/3P	<input type="checkbox"/> PW e bardhë polare polar white
PE20	KAPAK KS NJËSH COVER KS SINGLE		<input type="checkbox"/> IW e bardhë fildishi ivory white
PE21	KAPAK KS DYSH COVER KS DOUBLE		<input type="checkbox"/> ES e argjendtë elox elox silver
⋮	⋮	⋮	<input type="checkbox"/> CO termoset i bardhë white thermoset
			<input type="checkbox"/> NB e zezë mesnate night black

## KAPAK TV-R 2P/3P

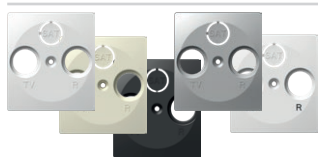

- PE10PW
- PE10IW
- PE10ES
- PE10CO
- PE10NB

- kapak TV-R, 2P ose 3P me vidë

*COVER TV-R 2P/3P*

- TV-R cover, 2P or 3P with screw



## KAPAK KS NJËSH

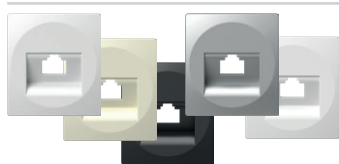

- PE20PW
- PE20IW
- PE20ES
- PE20CO
- PE20NB

- kapak KS njësh

*COVER KS SINGLE*

- KS cover single



## KAPAK KS DYSH

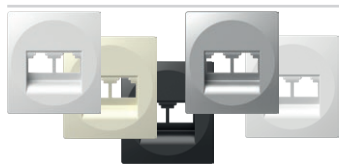

- PE21PW
- PE21IW
- PE21ES
- PE21NB

- kapak KS dysh

*COVER KS DOUBLE*

- KS cover double



## KAPAK TAE/TDO



- PE30PW
- PE30IW
- PE30ES
- PE30NB

- kapak TAE ose TDO me vidë

*COVER TAE/TDO*

- TAE or TDO cover with screw

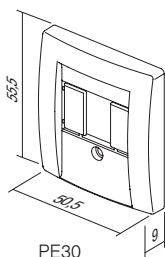

PE30

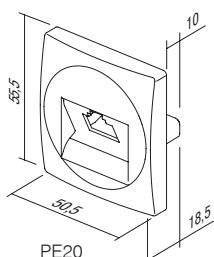

PE20

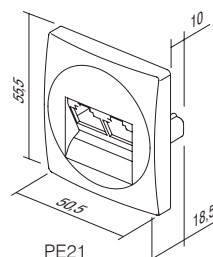

PE21

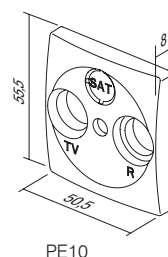

PE10



EE15

PW

lloji type	përshkrimi description	të dhënat teknike technical data	ngjyra colour
EE15	REOSTAT RROTULLUES ME 2 DREJTIME DIMMER ROTATIVE 2WAY	RL 400W	<input type="checkbox"/> PW e bardhë polare polar white
EE16	REOSTAT RROTULLUES ME 2 DREJTIME DIMMER ROTATIVE 2WAY	RLC 400W	<input type="checkbox"/> IW e bardhë fildishi ivory white
EE19	REOSTAT RROTULLUES ME 2 DREJTIME DIMMER ROTATIVE 2WAY	LED 100W	<input type="checkbox"/> ES e argjendtë elox elox silver
⋮	⋮	⋮	<input type="checkbox"/> CO termoset i bardhë white thermoset
⋮	⋮	⋮	<input type="checkbox"/> NB e zezë mesnate night black

#### REOSTAT RROTULLUES ME 2 DREJTIME RL 400 W



EE15

- kontroll i rrotullimit me çelësin me 2 drejtime
- RL i ngarkesës, 40 W - 400W
- është i mundur kombinimi i çelësit me 2 drejtime
- nuk lejohet kombinim i më shumë reostateve
- në përputhje me standardet EN 60669-1 dhe EN 60669-2-1
- kontakte për futje telash 1,5 mm<sup>2</sup>
- tensioni i furnizimit, 230 V ~ 50 Hz
- diametri i brendshëm i butonit Ø6 mm
- përfshihet siguresa e zëvendësueshme

#### DIMMER ROTATIVE 2WAY RL 400W

- rotation control with 2-way switch
- load RL, 40W - 400W
- 2-way switch combination is possible
- more dimmers combination is not allowed
- in accordance with EN 60669-1 and EN 60669-2-1
- plug-in contacts 1.5mm<sup>2</sup>
- supply 230V~ 50Hz
- button inner diameter Ø6mm
- replaceable fuse included

#### REOSTAT RROTULLUES ME 2 DREJTIME RLC 400 W



EE16

- kontroll i rrotullimit me çelësin me 2 drejtime
- RLC i ngarkesës, 20W - 400W
- është i mundur kombinimi i çelësit me 2 drejtime
- nuk lejohet kombinim i më shumë reostateve
- në përputhje me standardet EN 60669-1 dhe EN 60669-2-1
- kontakte për futje telash 1,5 mm<sup>2</sup>
- tensioni i furnizimit, 230 V ~ 50 Hz
- diametri i brendshëm i butonit Ø6 mm
- siguresë elektronike

#### DIMMER ROTATIVE 2WAY RLC 400W

- rotation control with 2-way switch
- load RLC, 20W - 400W
- 2-way switch combination is possible
- more dimmers combination is not allowed
- in accordance with EN 60669-1 and EN 60669-2-1
- plug-in contacts 1.5mm<sup>2</sup>
- supply 230V~ 50Hz
- button inner diameter Ø6mm
- electronic fuse



EE19

#### REOSTAT RROTULLUES ME 2 DREJTIME LED 100W

- kontroll i rrotullimit me çelësin me 2 drejtime
- ngarkesa: LED, 0-100 W (maks. 10 LED-e)  
GLS, 10-250 W
- është i mundur kombinimi i çelësit me 2 drejtime
- nuk lejohet kombinim i më shumë reostateve
- në përputhje me standardet EN 60669-1 dhe EN 60669-2-1
- kontakte për futje telash 1,5 mm<sup>2</sup>
- tensioni i furnizimit, 230 V ~ 50 Hz
- përfshihet siguresa e zëvendësueshme
- diametri i brendshëm i butonit Ø6 mm

#### DIMMER ROTATIVE 2WAY LED 100W

- rotation control with 2-way switch
- load: LED, 0-100W (max. 10 LEDs)  
GLS, 10-250W
- 2-way switch combination is possible
- more dimmers combination is not allowed
- in accordance with EN 60669-1 and EN 60669-2-1
- plug-in contacts 1.5mm<sup>2</sup>
- supply 230V~ 50Hz
- replaceable fuse included
- button inner diameter Ø6mm

#### ÇELËS IR 5A X 250V~

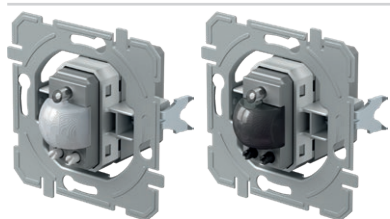

- EE32A1
- EE32A2

- çelës IR me infra të kuqe
- furnizimi me energji: 230 V ~ ±10 % 50 Hz
- rele: 5 A / 250 V~ (zero kryqëzim)
- vlerësimi i mbrojtjes: IP40
- prerja e tërthortë e telave në kontakt 0,75 - 2,5 mm<sup>2</sup>
- zona e zbulimit: deri në 110° në 20°C
- zona e zbulimit: rreth 8 m në 20°C
- rregullimi i kohëzgjatjes: nga rreth 5 sek. në 12 min.
- rregullimi i ndriçimit: nga rreth 5 deri 200 LUX
- temperatura e funksionimit: nga 0°C në +40°C
- i papërshtatshëm për instalim në kuti me thellësi 45 mm
- vetëm për përdorim të brendshëm

#### IR SWITCH 5A 230V~

- IR infrared switch
- supply voltage: 230V~ ±10 % 50Hz
- relay: 5A / 250V~ (zero crossing)
- protection rating: IP40
- cross-section of wires at the contact terminal: 0.75 - 2.5 mm<sup>2</sup>
- detection angle: up to 110° at 20°C
- detection area: approx. 8 m at 20°C
- adjustability of duration: from approx. 5 s to 12 min
- adjustability of brightness: from approx. 5 to 200 LUX
- operating temperature: from 0°C to +40°C
- not suitable for installation in 45 mm deep boxes
- only for indoor usage

#### NJËSIA E FURNIZIMIT ME ENERGJI USB 5 V 2,4 A



EE67

- për karikimin e pajisjeve elektronike përmes një porte standarde USB (e përputhshme gjithashtu edhe me pajisjet Apple)
- furnizimi me energji: 100-230 V~ 50/60 Hz
- konsumi i energjisë: 300 mA në 100 V~/150 mA në 230 V~
- konsumi i energjisë në gatishmëri: 30mW në 230 V~
- tensioni nominal në dalje: 5 VCD (±5 %) SELV
- tensioni i ondulacionit në dalje: 150 mV
- rryma nominale në dalje: 2,4 A (±10%)
- lloji i konektorit: USB A / USB A
- efikasiteti: maksimumi 77%
- temperatura e funksionimit: 0°C/+45°C (përdorimi i brendshëm)
- klasi i mbrojtjes IP: IP20, vetëm për përdorim në ambiente të brendshme
- klasi i pajisjes II
- kategoria e mbtensionit (EN 62109): Klasi III
- kontaktet e vidave maks. 2,5 mm<sup>2</sup>
- pajisje me hapësirë kontakti prej të paktën 3 mm
- në përputhje me standardet EN 60950-1 dhe Direktivës LVC dhe EMC

#### USB POWER SUPPLY UNIT 5V 2.4A

- for charging electronic devices via a standard USB port (also compatible with Apple devices)
- power supply: 100-230V~ 50/60Hz
- power consumption: 300mA at 100V~/150mA at 230V~
- standby power consumption: 30mW at 230V~
- nominal output voltage: 5 VCD (± 5%) SELV
- output ripple voltage: 150mV
- nominal output current: 2.4A (±10%)
- connector type: USB A / USB A
- efficiency: maximum of 77%
- operating temperature: 0°C/+45°C (indoor use)
- IP protection class: IP20, indoor use only
- class device II
- overvoltage category (EN 62109): Class III
- screw contacts: max. 2.5 mm<sup>2</sup>
- device with a contact gap of at least 3mm
- in accordance with the EN 60950-1 and LVD & EMC directives

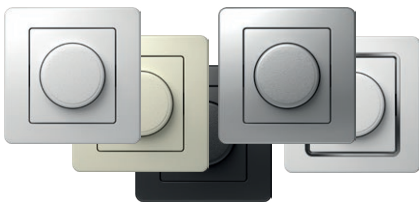

- EE15PW
- EE15IW
- EE15ES
- EE15CO
- EE15NB

#### REOSTAT RROTULLUES ME 2 DREJTIME RL 400 W

- kontroll i rrotullimit me çelësin me 2 drejtime
- RL i ngarkesës, 40 W - 400W
- është i mundur kombinimi i çelësit me 2 drejtime
- nuk lejohet kombinim i më shumë reostateve
- në përputhje me standardet EN 60669-1 dhe EN 60669-2-1
- kontakte për futje telash 1,5 mm<sup>2</sup>
- tensioni i furnizimit, 230 V ~ 50 Hz
- përfshihet siguresa e zëvendësueshme

#### DIMMER ROTATIVE 2WAY RL 400W

- rotation control with 2-way switch
- load RL, 40W - 400W
- 2-way switch combination is possible
- more dimmers combination is not allowed
- in accordance with EN 60669-1 and EN 60669-2-1
- plug-in contacts 1.5mm<sup>2</sup>
- supply 230V~ 50Hz
- replaceable fuse included

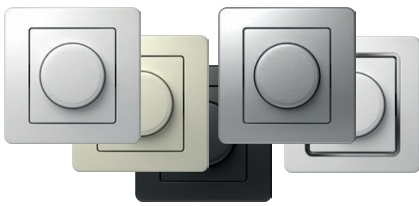

- EE16PW
- EE16IW
- EE16ES
- EE16CO
- EE16NB

#### REOSTAT RROTULLUES ME 2 DREJTIME RLC 400 W

- kontroll i rrotullimit me çelësin me 2 drejtime
- RLC i ngarkesës, 20W - 400W
- është i mundur kombinimi i çelësit me 2 drejtime
- nuk lejohet kombinim i më shumë reostateve
- në përputhje me standardet EN 60669-1 dhe EN 60669-2-1
- kontakte për futje telash 1,5 mm<sup>2</sup>
- tensioni i furnizimit, 230 V ~ 50 Hz
- siguresë elektronike

#### DIMMER ROTATIVE 2WAY RLC 400W

- rotation control with 2-way switch
- load RLC, 20W - 400W
- 2-way switch combination is possible
- more dimmers combination is not allowed
- in accordance with EN 60669-1 and EN 60669-2-1
- plug-in contacts 1.5mm<sup>2</sup>
- supply 230V~ 50Hz
- electronic fuse

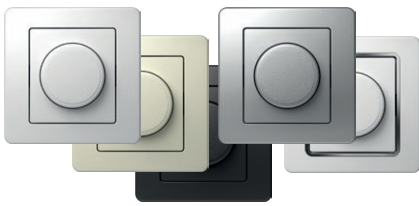

- EE19PW
- EE19IW
- EE19ES
- EE19CO
- EE19NB

#### REOSTAT RROTULLUES ME 2 DREJTIME LED 100W

- kontroll i rrotullimit me çelësin me 2 drejtime
- ngarkesa: LED, 0-100 W (maks. 10 LED-e)
- GLS, 10-250 W
- është i mundur kombinimi i çelësit me 2 drejtime
- nuk lejohet kombinim i më shumë reostateve
- në përputhje me standardet EN 60669-1 dhe EN 60669-2-1
- kontakte për futje telash 1,5 mm<sup>2</sup>
- tensioni i furnizimit, 230 V ~ 50 Hz
- përfshihet siguresa e zëvendësueshme

#### DIMMER ROTATIVE 2WAY LED 100W

- rotation control with 2-way switch
- load: LED, 0-100W (max. 10 LEDs)
- GLS, 10-250W
- 2-way switch combination is possible
- more dimmers combination is not allowed
- in accordance with EN 60669-1 and EN 60669-2-1
- plug-in contacts 1.5mm<sup>2</sup>
- supply 230V~ 50Hz
- replaceable fuse included



- EE32PW
- EE32IW
- EE32ES
- EE32CO
- EE32NB

#### ÇELËS IR 5A X 230V~

- çelës IR me infra të kuqe
- furnizimi me energji: 230 V~ ±10 % 50 Hz
- rele: 5 A / 250 V~ (zero kryqëzim)
- vlerësimi i mbrojtjes: IP40
- preja e tërthorë e telave në kontakt 0,75 - 2,5 mm<sup>2</sup>
- zona e zbulimit: deri në 110° në 20°C
- zona e zbulimit: rreth 8 m në 20°C
- rregullimi i kohëzgjatjes: nga rreth 5 sek. në 12 min.
- rregullimi i ndriçimit: nga rreth 5 deri 200 LUX
- temperatura e funksionimit: nga 0°C në +40°C
- i papërshtatshëm për instalim në kuti me thellësi 45 mm
- vetëm për përdorim të brendshëm

#### IR SWITCH 5A 230V~

- IR infrared switch
- supply voltage: 230V~ ±10 % 50Hz
- relay: 5A / 250V~ (zero crossing)
- protection rating: IP40
- cross-section of wires at the contact terminal: 0.75 - 2.5 mm<sup>2</sup>
- detection angle: up to 110° at 20°C
- detection area: approx. 8 m at 20°C
- adjustability of duration: from approx. 5 s to 12 min
- adjustability of brightness: from approx. 5 to 200 LUX
- operating temperature: from 0°C to +40°C
- not suitable for installation in 45 mm deep boxes
- only for indoor usage





- EE67PW
- EE67IW
- EE67NB
- EE67ES

#### NJËSIA E FURNIZIMIT ME ENERGJI USB 5 V 2,4 A

- për karikimin e pajisjeve elektronike përmes një porte standarde USB (e përputhshme gjithashtu edhe me pajisjet Apple)
- furnizimi me energji: 100-230 V~ 50/60 Hz
- konsumi i energjisë: 300 mA në 100 V~/150 mA në 230 V~
- konsumi i energjisë në gatishtëri: 30mW në 230 V~
- tensioni nominal në dalje: 5 VCD ( $\pm 5\%$ ) SELV
- tensioni i ondulacionit në dalje: 150 mV
- rryma nominale në dalje: 2,4 A ( $\pm 10\%$ )
- lloji i konektorit: USB A / USB A
- efikasiteti: maksimumi 77%
- temperatura e funksionimit: 0°C/+45°C (përdorimi i brendshëm)
- klasi i mbrojtjes IP: IP20, vetëm për përdorim në ambiente të brendshme
- klasi i pajisjes II
- kategoria e mbritensionit (EN 62109): Klasi III
- kontaktet e vidave maks. 2,5 mm<sup>2</sup>
- pajisje me hapësirë kontakti prej të paktën 3 mm
- në përputhje me standardet EN 60950-1 dhe Direktivës LVC dhe EMC



#### USB POWER SUPPLY UNIT 5V 2.4A

- for charging electronic devices via a standard USB port (also compatible with Apple devices)
- power supply: 100-230V~ 50/60Hz
- power consumption: 300mA at 100V~/150mA at 230V~
- standby power consumption: 30mW at 230V~
- nominal output voltage: 5 VCD ( $\pm 5\%$ ) SELV
- output ripple voltage: 150mV
- nominal output current: 2.4A ( $\pm 10\%$ )
- connector type: USB A / USB A
- efficiency: maximum of 77%
- operating temperature: 0°C/+45°C (indoor use)
- IP protection class: IP20, indoor use only
- class device II
- overvoltage category (EN 62109): Class III
- screw contacts: max. 2.5 mm<sup>2</sup>
- device with a contact gap of at least 3mm
- in accordance with the EN 60950-1 and LVD & EMC directives

EE15, EE16, EE19

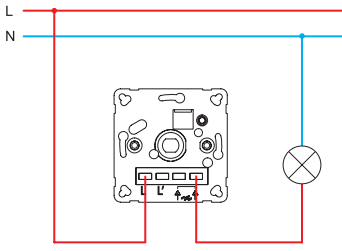

EE15, EE16, EE19

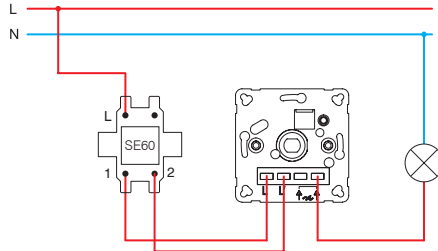

EE15, EE16, EE19

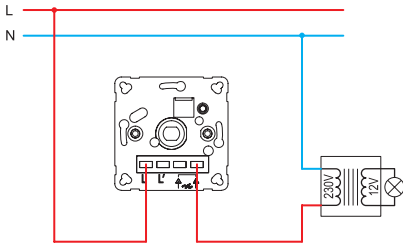

EE15, EE16, EE19

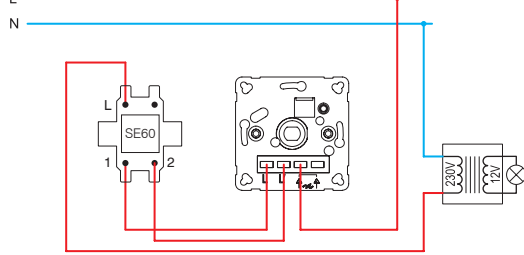

EE16, EE19

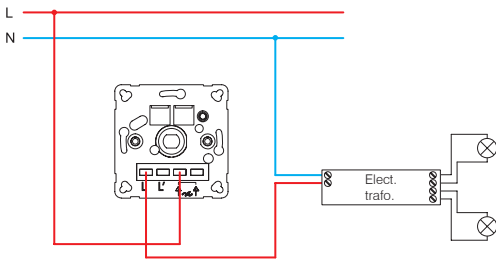

EE16, EE19

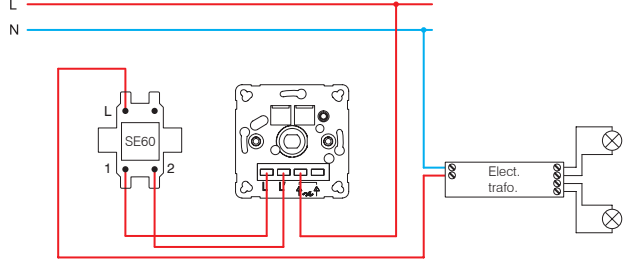

EE15 (40÷400W)

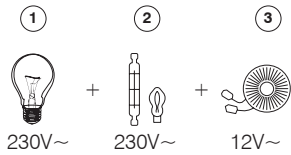

- 1 - llambë inkandeshente / incandescent lamp
- 2 - llambë halogjene / halogen lamp

EE16 (20÷400W)

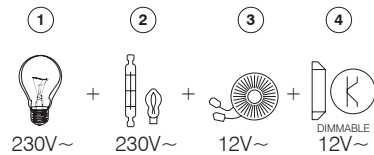

- 3 - transformator klasik / classical transformer
- 4 - transformator elektrik me dimer / dimmable electronic transformer

EE19 (GLS 10÷250W ; LED 0÷100W)

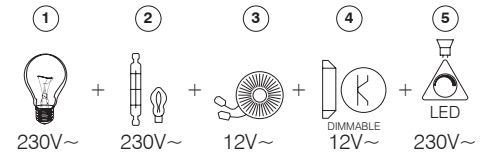

- 5 - llambë LED me ulje ndriçimi / dimmable LED lamp

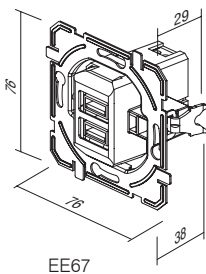

EE67

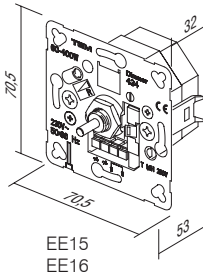

EE15  
EE16  
EE19

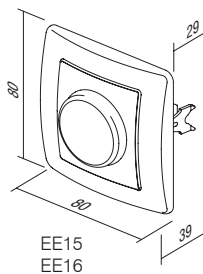

EE15  
EE16  
EE19

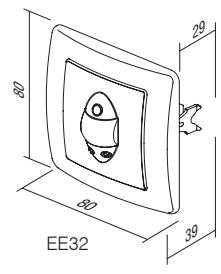

EE32

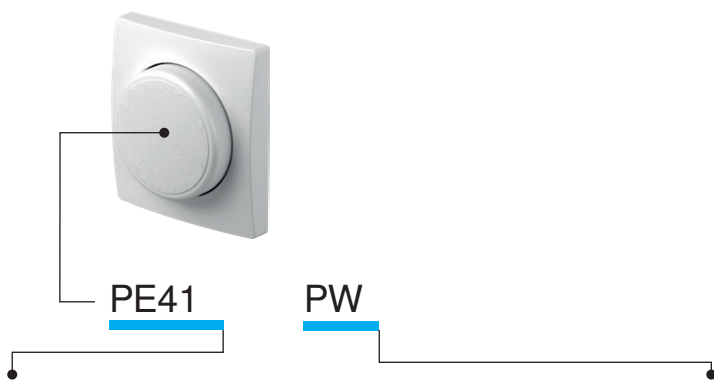

lloji type	përshkrimi description	ngjyra colour
PE41	REOSTAT ME KAPAK COVER DIMMER	<input type="checkbox"/> PW e bardhë polare polar white  <input type="checkbox"/> IW e bardhë fildishi ivory white  <input type="checkbox"/> ES e argjendtë elox elox silver  <input type="checkbox"/> CO termoset i bardhë white thermoset  <input type="checkbox"/> NB e zezë mesnate night black

#### REOSTAT ME KAPAK Ø6



- PE41PW
- PE41IW
- PE41NB
- PE41ES
- PE41CO

- reostat me kapak Ø6 mm  
- me EE15, EE16, EE19  
**COVER DIMMER Ø6**  
- cover dimmer Ø6mm  
- for EE15, EE16, EE19



#### KAPAK ÇELËS IR



- PE32PW
- PE32IW
- PE32NB
- PE32ES

- kapak çelës IR  
**COVER IR SWITCH**  
- cover IR switch



#### NJËSIA E FURNIZIMIT ME USB ME KAPAK



- PE67PW
- PE67IW
- PE67NB
- PE67ES

- Kapaku i njësisë së furnizimit me USB  
**USB SUPPLY UNIT COVER**  
- USB supply unit cover

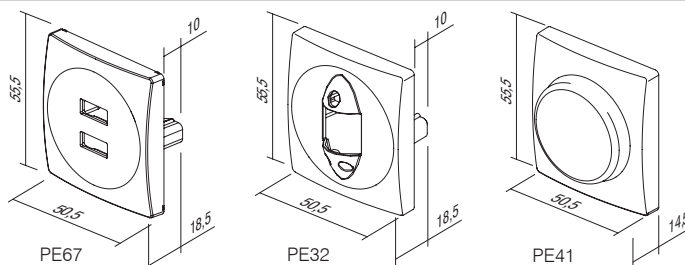



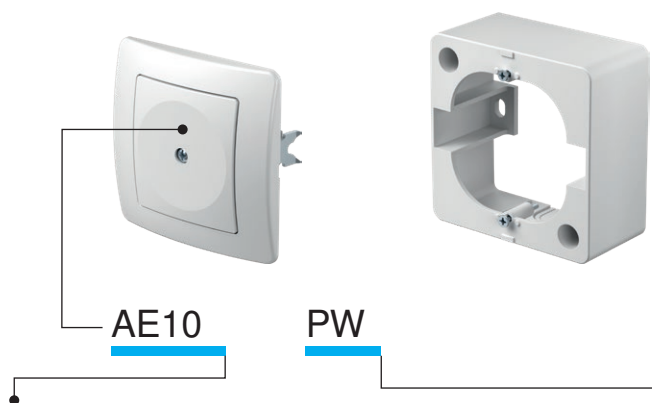

Iloji type	përshkrimi description	ngjyra colour
AE10	FALSO BLANK	<input type="checkbox"/> PW e bardhë polare polar white
AE20	KUTI LIDHJEJE 3P+N+E 5X4 mm <sup>2</sup> CONNECTION BOX 3P+N+E 5X4mm <sup>2</sup>	<input type="checkbox"/> IW e bardhë fildishi ivory white
AE30	KUTI ME MONTIM NË SIPËRFAQE NO 1 SURFACE MOUNT BOX	<input type="checkbox"/> ES e argjendtë elox elox silver
⋮	⋮	<input type="checkbox"/> CO termoset i bardhë white thermoset
⋮	⋮	<input type="checkbox"/> NB e zezë mesnate night black

**FALSO**

- për mbushjen e hapësirave boshe

**BLANK**

- for filling up empty spaces

- AE10PW
- AE10IW
- AE10NB
- AE10ES
- AE10CO

**KUTI LIDHJEJE 5 POLARE 3P+N+E 5X4 mm<sup>2</sup>**

- kuti lidhjeje 3P+N+E
- 16 A 400V~
- në përputhje me VDE 0606-1:2000
- kontaktet e vidave 1,5-4mm<sup>2</sup>

**CONNECTION BOX 5POLE 3P+N+E 5x4mm<sup>2</sup>**

- 3P+N+E connection box
- 16A 400V~
- in accordance with VDE 0606-1:2000
- screw contacts 1.5-4mm<sup>2</sup>

- AE20PW
- AE20IW

**KUTI ME MONTIM NË SIPËRFAQE 1**

- kuti me montim në sipërfaqe

**SURFACE MOUNT BOX 1**

- surface mounting box

- AE30PW
- AE30IW

**KUTI SIPËRFAQËSORE PËR PRIZË DYSHE EKONOMIK**

- kuti me montim në sipërfaqe

**SURFACE MOUNT BOX FOR EKONOMIK DOUBLE SOCKET**

- surface mounting box

- AE31PW

MBROJTJE PËR MUR



- AE50PW
- AE50TS

- mbron sipërfaqen rrotull prizës ose çelësit

*WALL PROTECTION*

- protects surface around socket or switch

MBROJTJE PËR FËMIJËT KS



- AE51PW
- AE51IW

- insert shtesë KS për mbrojtje për fëmijët

*CHILD PROTECTION KS*

- KS additional child protection insert - shuttered live contacts

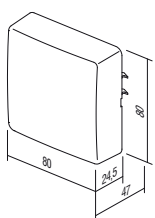

AE20

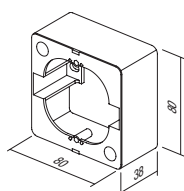

AE30

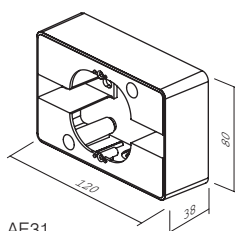

AE31

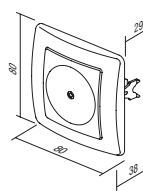

AE10

## S U R R O U N D S O E



OE10



PW

Iloji type	përshkrimi description	ngjyra colour
OE10	RRETHUES EKONOMIK 1 SURROUND EKONOMIK 1	<input type="checkbox"/> PW e bardhë polare polar white
OE20	RRETHUES EKONOMIK 2 HORIZONTAL SURROUND EKONOMIK 2 HORIZONTAL	<input type="checkbox"/> IW e bardhë fildishi ivory white
OE30	RRETHUES EKONOMIK 3 HORIZONTAL SURROUND EKONOMIK 3 HORIZONTAL	<input type="checkbox"/> ES e argjendtë elox elox silver
⋮	⋮	<input type="checkbox"/> CO termoset i bardhë white thermoset
⋮	⋮	<input type="checkbox"/> NB e zezë mesnate night black

## RRETHUES EKONOMIK 1



- OE10PW
- OE10IW
- OE10ES
- OE10CO
- OE10NB

- rrethues dekorativ me 1 pozicion  
- në përputhje me EN 60669-1

**SURROUND EKONOMIK 1**  
- decorative surround 1-gang  
- in accordance with EN 60669-1

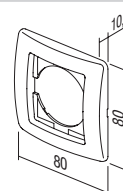

## RRETHUES EKONOMIK 2 HORIZONTAL



- OE20PW
- OE20IW
- OE20ES
- OE20CO
- OE20NB

- rrethues dekorativ me 2 pozicione horizontal  
- në përputhje me EN 60669-1

**SURROUND EKONOMIK 2 HORIZONTAL**  
- decorative surround 2-gang horizontal  
- in accordance with EN 60669-1

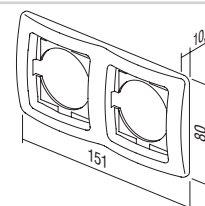

## RRETHUES EKONOMIK 2 VERTIKAL



- OE21PW
- OE21IW
- OE21ES
- OE21CO
- OE21NB

- rrethues dekorativ me 2 pozicione vertikal  
- në përputhje me EN 60669-1

**SURROUND EKONOMIK 2 VERTICAL**  
- decorative surround 2-gang vertical  
- in accordance with EN 60669-1

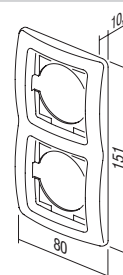

## RRETHUES EKONOMIK 3 HORIZONTAL



- OE30PW
- OE30IW
- OE30ES
- OE30CO
- OE30NB

- rrethues dekorativ me 3 pozicione horizontal  
- në përputhje me EN 60669-1

**SURROUND EKONOMIK 3 HORIZONTAL**  
- decorative surround 3-gang horizontal  
- in accordance with EN 60669-1

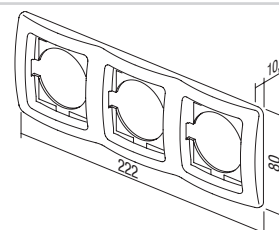



- OE31PW
- OE31IW
- OE31ES
- OE31CO
- OE31NB

**RRETHUES EKONOMIK 3 VERTIKAL**

- rrethues dekorativ me 3 pozicione vertikal  
- në përputhje me EN 60669-1

**SURROUND EKONOMIK 3 VERTIKAL**

- decorative surround 3-gang vertical  
- in accordance with EN 60669-1

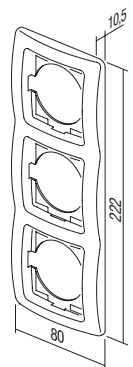

- OE40PW
- OE40IW
- OE40ES
- OE40NB

**RRETHUES EKONOMIK 4 HORIZONTAL**

- rrethues dekorativ me 4 pozicione horizontal  
- në përputhje me EN 60669-1

**SURROUND EKONOMIK 4 HORIZONTAL**

- decorative surround 4-gang horizontal  
- in accordance with EN 60669-1

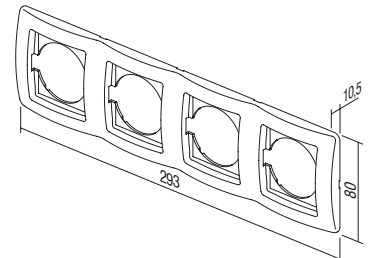

- OE41PW
- OE41IW
- OE41ES
- OE41NB

**RRETHUES EKONOMIK 4 VERTIKAL**

- rrethues dekorativ me 4 pozicione vertikal  
- në përputhje me EN 60669-1

**SURROUND EKONOMIK 4 VERTIKAL**

- decorative surround 4-gang vertical  
- in accordance with EN 60669-1

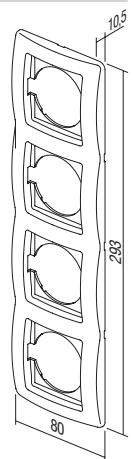

- OE50PW
- OE50IW
- OE50ES
- OE50NB

**RRETHUES EKONOMIK 5 HORIZONTAL**

- rrethues dekorativ me 5 pozicione horizontal  
- në përputhje me EN 60669-1

**SURROUND EKONOMIK 5 HORIZONTAL**

- decorative surround 5-gang horizontal  
- in accordance with EN 60669-1

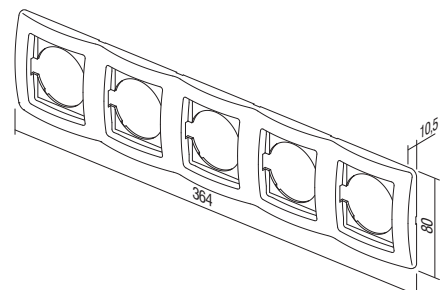

KORNIZA DEKORATIVE ME NGJYRA /  
 COLOR DECORATIVE FRAMES



OE90GR E GJELBËR /  
 GREEN  
 OE90BL BLU /  
 BLUE  
 OE90VO VJOLLÇË /  
 VIOLET  
 OE90PI ROZË /  
 PINK  
 OE90RD E KUQE /  
 RED

OE90YL E VERDHË /  
 YELLOW  
 OE90WH E BARDHË /  
 WHITE  
 OE90GY GRI /  
 GREY  
 OE90BK E ZEZË /  
 BLACK

OE90MB MET. BLU /  
 MET. BLUE  
 OE90BZ BRONZ /  
 BRONZE  
 OE90CR E ARGJENDTË /  
 SILVER  
 OE90GO E ARTË /  
 GOLD





**fontana**



**TEM**





SF10

PW

TI

Iloji type	përshkrimi description	të dhënat teknike technical data	ngjyra colour	të dhënat opsionale 1 optional data 1
SF10	ÇELËS ME 1 DREJTIM SWITCH 1WAY	IP44 10AX 250V~	<input type="checkbox"/> PW e bardhë-mat white-mat	TI llambë neoni+tregues neon lamp+indication
SF11	BUTON MESHTYRJE ME 1 DREJTIM PUSH BUTTON 1WAY	IP44 10A 250V~	<input checked="" type="checkbox"/> GY gri-mat grey-mat	
SF20	ÇELËS 2 POLAR SWITCH 2POLE	IP44 10AX 250V~		
:	:	:		
:	:	:		

ÇELËS ME 1 DREJTIM IP44 10 A X 250 V~



- SF10PW
- SF10GY

- 10 A X 250 V~, Iloji SF10  
- në përputhje me EN 60669-1  
- kontakte për futje telash 1,5-2,5 mm<sup>2</sup>  
*SWITCH 1WAY IP44 10AX 250V~*  
- 10AX 250V~, type SF10  
- in accordance with EN 60669-1  
- plug-in contacts 1.5-2.5mm<sup>2</sup>



ÇELËS ME 1 DREJTIM IP44 10 A X 250 V~ \_\_ TI



- SF10PWTI
- SF10GYTI

- TI tregues+llambë neoni  
- 10 A X 250 V~, Iloji SF10  
- në përputhje me EN 60669-1  
- kontakte për futje telash 1,5-2,5 mm<sup>2</sup>  
*SWITCH 1WAY IP44 10AX 250V~ \_\_ TI*  
- TI indicator+neon lamp  
- 10AX 250V~, type SF10  
- in accordance with EN 60669-1  
- plug-in contacts 1.5-2.5mm<sup>2</sup>



BUTON ME SHTYRJE ME 1 DREJTIM IP44 10 A 250 V~ \_\_ TI



- SF11PWTI
- SF11GYTI

- TI tregues+llambë neoni  
- 10A 250 V~, Iloji SF11  
- në përputhje me EN 60669-1  
- kontakte për futje telash 1,5-2,5 mm<sup>2</sup>  
*PUSH BUTTON 1WAY IP44 10A 250V~ \_\_ TI*  
- TI indicator+neon lamp  
- 10A 250V~, type SF11  
- in accordance with EN 60669-1  
- plug-in contacts 1.5-2.5mm<sup>2</sup>



ÇELËS ME 2 DREJTIME IP44 10 A X 250 V~















- SF20PW
- SF20GY

- 10 A X 250 V~, Iloji SF20  
- në përputhje me EN 60669-1  
- kontakte për futje telash 1,5-2,5 mm<sup>2</sup>  
*SWITCH 2POLE IP44 10AX 250V~*  
- 10AX 250V~, type SF20  
- in accordance with EN 60669-1  
- plug-in contacts 1.5-2.5mm<sup>2</sup>





	<input type="checkbox"/> SF50PW <input checked="" type="checkbox"/> SF50GY	<p><b>ÇELËS ME 2 POZICIONE 1 DREJTIM IP44 10 A X 250 V~</b></p> <ul style="list-style-type: none"> <li>- 10 A X 250 V~, Iloji SF50</li> <li>- në përputhje me EN 60669-1</li> <li>- kontakte për futje telash 1,5-2,5 mm<sup>2</sup></li> </ul> <p><i>SWITCH 2GANG-1WAY IP44 10AX 250V~</i></p> <ul style="list-style-type: none"> <li>- 10AX 250V~, type SF50</li> <li>- in accordance with EN 60669-1</li> <li>- plug-in contacts 1.5-2.5mm<sup>2</sup></li> </ul>	
	<input type="checkbox"/> SF51PW <input checked="" type="checkbox"/> SF51GY	<p><b>BUTON ME SHYTPJE ME 2 POZICIONE - 1 DREJTIM IP44 10A 250 V~</b></p> <ul style="list-style-type: none"> <li>- 10A 250 V~, Iloji SF51</li> <li>- në përputhje me EN 60669-1</li> <li>- kontakte për futje telash 1,5-2,5 mm<sup>2</sup></li> </ul> <p><i>PUSH BUTTON 2GANG-1WAY IP44 10A 250V~</i></p> <ul style="list-style-type: none"> <li>- 10A 250V~, type SF51</li> <li>- in accordance with EN 60669-1</li> <li>- plug-in contacts 1.5-2.5mm<sup>2</sup></li> </ul>	
	<input type="checkbox"/> SF60PW <input checked="" type="checkbox"/> SF60GY	<p><b>ÇELËS ME 2 DREJTIME IP44 10 A X 250 V~</b></p> <ul style="list-style-type: none"> <li>- 10 A X 250 V~, Iloji SF60</li> <li>- në përputhje me EN 60669-1</li> <li>- kontakte për futje telash 1,5-2,5 mm<sup>2</sup></li> </ul> <p><i>SWITCH 2WAY IP44 10AX 250V~</i></p> <ul style="list-style-type: none"> <li>- 10AX 250V~, type SF60</li> <li>- in accordance with EN 60669-1</li> <li>- plug-in contacts 1.5-2.5mm<sup>2</sup></li> </ul>	
	<input type="checkbox"/> SF60PWTI <input checked="" type="checkbox"/> SF60GYTI	<p><b>ÇELËS ME 2 DREJTIME IP44 10 A X 250 V~ __ TI</b></p> <ul style="list-style-type: none"> <li>- TI tregues+llambë neoni</li> <li>- 10 A X 250 V~, Iloji SF60</li> <li>- në përputhje me EN 60669-1</li> <li>- kontakte për futje telash 1,5-2,5 mm<sup>2</sup></li> </ul> <p><i>SWITCH 2WAY IP44 10AX 250V~ __ TI</i></p> <ul style="list-style-type: none"> <li>- TI indicator+neon lamp</li> <li>- 10AX 250V~, type SF60</li> <li>- in accordance with EN 60669-1</li> <li>- plug-in contacts 1.5-2.5mm<sup>2</sup></li> </ul>	
	<input type="checkbox"/> SF63PW <input checked="" type="checkbox"/> SF63GY	<p><b>ÇELËS ME 2 DREJTIME DYSH IP44 10 A X 250 V~</b></p> <ul style="list-style-type: none"> <li>- 10 A X 250 V~, Iloji SF63</li> <li>- në përputhje me EN 60669-1</li> <li>- kontakte për futje telash 1,5-2,5 mm<sup>2</sup></li> </ul> <p><i>SWITCH 2WAY DOUBLE IP44 10AX 250V~</i></p> <ul style="list-style-type: none"> <li>- 10AX 250V~, type SF63</li> <li>- in accordance with EN 60669-1</li> <li>- plug-in contacts 1.5-2.5mm<sup>2</sup></li> </ul>	
	<input type="checkbox"/> SF70PW <input checked="" type="checkbox"/> SF70GY	<p><b>ÇELËS NDËRMJETËS IP44 10 A X 250 V~</b></p> <ul style="list-style-type: none"> <li>- 10 A X 250 V~, Iloji SF70</li> <li>- në përputhje me EN 60669-1</li> <li>- kontakte për futje telash 1,5-2,5 mm<sup>2</sup></li> </ul> <p><i>SWITCH INTERMEDIATE IP44 10AX 250V~</i></p> <ul style="list-style-type: none"> <li>- 10AX 250V~, type SF70</li> <li>- in accordance with EN 60669-1</li> <li>- plug-in contacts 1.5-2.5mm<sup>2</sup></li> </ul>	

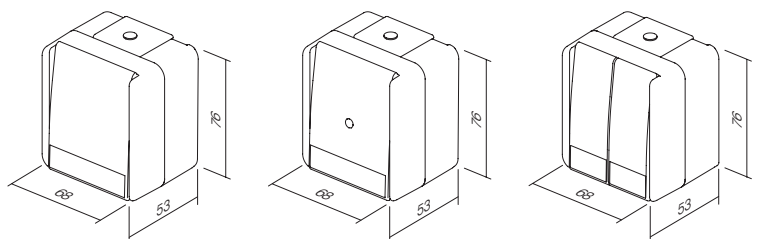

P R I Z A T V F  
S O C K E T S



VF10

PW

Iloji type	përshkrimi description	të dhënat teknike technical data	ngjyra colour
VF10	PRIZË SCHUKO+KAPAK SOCKET SCHUKO+COVER	IP44 2P+E 16A 250V~	<input type="checkbox"/> PW e bardhë-mat white-mat  <input type="checkbox"/> GY gri-mat grey-mat

PRIZË SCHUKO+KAPAK IP44 2P+E 16 A 250 V~



- VF10PW
- VF10GY

- kontaktet e vidave 1,5-2,5 mm<sup>2</sup>
- 2P+E schuko+kapak
- 16 A 250 V~, Iloji VF10
- në përputhje me EN 60884-1, CEE7

SOCKET SCHUKO+COVER IP44 2P+E 16A 250V~

- screw contacts 1.5-2.5mm<sup>2</sup>
- 2P+E schuko+cover
- 16A 250V~, type VF10
- in accordance with EN 60884-1, CEE7



PRIZË SCHUKO+KAPAK IP44 2P+E 16 A 250 V~ BV



- VF12PW
- VF12GY

- BV kontakte për futje telash 1,5-2,5 mm<sup>2</sup>
- 2P+E schuko+kapak
- 16 A 250 V~, Iloji VF12
- në përputhje me EN 60884-1, CEE7

SOCKET SCHUKO+COVER IP44 2P+E 16A 250V~ BV

- BV plug-in contacts 1.5-2.5mm<sup>2</sup>
- 2P+E schuko+cover
- 16A 250V~, type VF12
- in accordance with EN 60884-1, CEE7

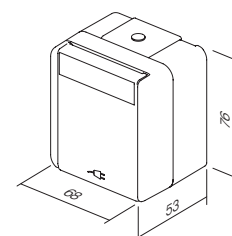

SF10  
SF60

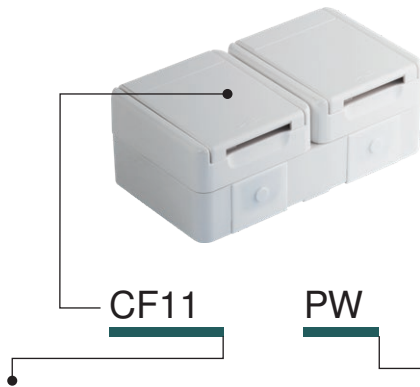

Iloji type	përshkrimi description	të dhënat teknike technical data	ngjyra colour
CF10	PRIZË SET SCHUKO DYSHE HORIZ SOCKET SET SCHUKO DOUBLE HORIZ	2x 2P+E 16A 250V~ IP44	<input type="checkbox"/> PW e bardhë-mat white-mat
CF11	PRIZË SET SCHUKO DYSHE VERT SOCKET SET SCHUKO DOUBLE VERT	2x 2P+E 16A 250V~ IP44	<input checked="" type="checkbox"/> GY gri-mat grey-mat
CF12	PRIZË SCH+ÇELËS 2 DREJTIME HORIZ SOCKET SCH+SWITCH 2WAY HORIZ	16A + 10A 250V~ IP44	
⋮	⋮	⋮	
⋮	⋮	⋮	

#### SET PRIZË SCHUKO DYSHE HORIZONTALE IP44 2x 2P+E 16 A 250 V~



- CF10PW
- CF10GY

- kontaktet e vidave 1,5-2,5 mm<sup>2</sup>
- 2x 2P+E schuko+kapak horizontale
- 16 A 250 V~, Iloji CF10
- në përputhje me EN 60884-1, CEE7

SOCKET SET SCHUKO DOUBLE  
HORIZONTAL IP44 2x 2P+E 16A 250V~  
- screw contacts 1.5-2.5mm<sup>2</sup>  
- 2x 2P+E schuko+cover horizontal  
- 16A 250V~, type CF10  
- in accordance with EN 60884-1, CEE7



#### SET PRIZË SCHUKO DYSHE VERTIKALE IP44 2x 2P+E 16 A 250 V~



- CF11PW
- CF11GY

- kontaktet e vidave 1,5-2,5 mm<sup>2</sup>
- 2x 2P+E schuko+kapak vertikale
- 16 A 250 V~, Iloji CF11
- në përputhje me EN 60884-1, CEE7

SOCKET SET SCHUKO DOUBLE VERTICAL  
IP44 2x 2P+E 16A 250V~  
- screw contacts 1.5-2.5mm<sup>2</sup>  
- 2x 2P+E schuko+cover vertical  
- 16A 250V~, type CF11  
- in accordance with EN 60884-1, CEE7



#### PRIZË SCH+SET ÇELËS 2 DREJTIME HORIZONTAL IP44 16 A + 10 A X 250 V~



- CF12PW
- CF12GY

- vidë (priza), futje (çelësi) kontaktet 1,5-2,5 mm<sup>2</sup>
- 2P+E schuko+kapak + çelës horizontal 2 drejtime
- 16 A + 10 A X 250 V~, Iloji CF12
- në përputhje me standardet EN 60884-1, CEE7, EN 60669-1

SOCKET SCH+SWITCH SET 2WAY  
HORIZONTAL IP44 16A + 10AX 250V~  
- screw (socket), plug-in (switch)  
contacts 1.5-2.5mm<sup>2</sup>  
- 2P+E schuko+cover + switch 2-way horizontal  
- 16A + 10AX 250V~, type CF12  
- in accordance with EN 60884-1, CEE7, EN 60669-1



## PRIZË SCH+SET ÇELËS 2 DREJTIME VERTIKAL IP44 16 A + 10 A X 250 V~



- CF13PW
- CF13GY

- vidë (priza), futje (çelësi)
- kontakte për futje telash 1,5-2,5 mm<sup>2</sup>
- 2P+E schuko+kapak + çelës 2 drejtime vertikal
- 16 A + 10 A X 250 V~, lloji CF13
- në përputhje me standardet EN 60884-1, CEE7, EN 60669-1

## SOCKET SCH+SWITCH 2WAY SET VERTICAL IP44 16A + 10AX 250V~

- screw (socket), plug-in (switch)
- contacts 1.5-2.5mm<sup>2</sup>
- 2P+E schuko+cover + switch 2-way vertical
- 16A + 10AX 250V~, type CF13
- in accordance with EN 60884-1, CEE7, EN 60669-1



## SET PRIZË SCHUKO DYSHE HORIZONTALE IP44 2x 2P+E 16 A 250 V~ BV



- CF14PW
- CF14GY

- BV kontakte për futje telash 1,5-2,5 mm<sup>2</sup>
- 2x 2P+E schuko+kapak horizontale
- 16 A 250 V~, lloji CF14
- në përputhje me EN 60884-1, CEE7

## SOCKET SET SCHUKO DOUBLE HORIZONTAL IP44 2x 2P+E 16A 250V~ BV

- BV plug-in contacts 1.5-2.5mm<sup>2</sup>
- 2x 2P+E schuko+cover horizontal
- 16A 250V~, type CF14
- in accordance with EN 60884-1, CEE7



## SET PRIZË SCHUKO DYSHE VERTIKALE IP44 2x 2P+E 16 A 250 V~ BV



- CF15PW
- CF15GY

- BV kontakte për futje telash 1,5-2,5 mm<sup>2</sup>
- 2x 2P+E schuko+kapak vertikale
- 16 A 250 V~, lloji CF15
- në përputhje me EN 60884-1, CEE7

## SOCKET SET SCHUKO DOUBLE VERTICAL IP44 2x 2P+E 16A 250V~ BV

- BV plug-in contacts 1.5-2.5mm<sup>2</sup>
- 2x 2P+E schuko+cover vertical
- 16A 250V~, type CF15
- in accordance with EN 60884-1, CEE7



## PRIZË+SET ÇELËS SCH+2 DREJTIME HORIZONTAL IP44 16 A + 10 A X 250 V~ BV



- CF16PW
- CF16GY

- BV kontakte për futje telash 1,5-2,5 mm<sup>2</sup>
- 2P+E schuko+kapak + çelës 2 drejtime horizontalisht
- 16 A + 10 A X 250 V~, lloji CF16
- në përputhje me standardet EN 60884-1, CEE7, EN 60669-1

## SOCKET+SWITCH SET SCH+2WAY HORIZONTAL IP44 16A + 10AX 250V~ BV

- BV plug-in contacts 1.5-2.5mm<sup>2</sup>
- 2P+E schuko+cover + switch 2-way horizontal
- 16A + 10AX 250V~, type CF16
- in accordance with EN 60884-1, CEE7, EN 60669-1



## PRIZË SCH+SET ÇELËS 2 DREJTIME VERTIKAL IP44 16 A + 10 A X 250 V~ BV



- CF17PW
- CF17GY

- BV kontakte për futje telash 1,5-2,5 mm<sup>2</sup>
- 2P+E schuko+kapak + çelës 2 drejtime vertikal
- 16 A + 10 A X 250 V~, lloji CF17
- në përputhje me standardet EN 60884-1, CEE7, EN 60669-1

## SOCKET SCH+SWITCH 2WAY SET VERTICAL IP44 16A + 10AX 250V~ BV

- BV plug-in contacts 1.5-2.5mm<sup>2</sup>
- 2P+E schuko+cover + switch 2-way vertical
- 16A + 10AX 250V~, type CF17
- in accordance with EN 60884-1, CEE7, EN 60669-1



A K S E S O R Ë T A F  
A C C E S S O R I E S

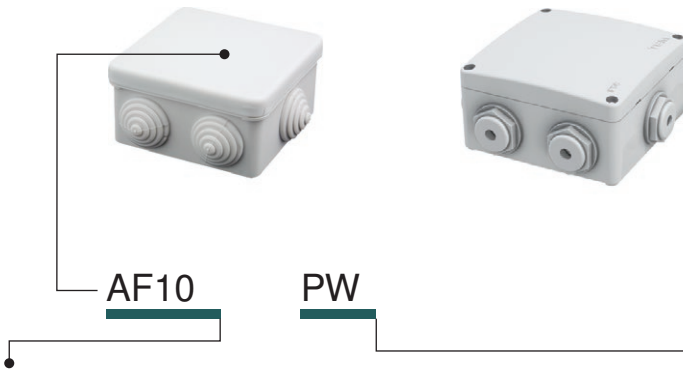

Iloji type	përshkrimi description	të dhënat teknike technical data	ngjyra colour
AF10	KUTI SHPËRNDARJEJE DISTRIBUTION BOX	IP44 RN01	<input type="checkbox"/> PW e bardhë-mat white-mat
AF20	KUTI SHPËRNDARJEJE DISTRIBUTION BOX	IP55 NDO1	<input type="checkbox"/> GY gri-mat grey-mat

KUTI SHPËRNDARJEJE IP44 RN01



- AF10PW
- AF10GY

- kuti shpërndarjeje me montim në sipërfaqe IP44
- 16 A 400V~
- në përputhje me standardet IEC/EN 60670-1, IEC/EN 60670-22

DISTRIBUTION BOX IP44 RN01

- surface mounting distribution box IP44
- 16A 400V~
- in accordance with IEC/EN 60670-1, IEC/EN 60670-22

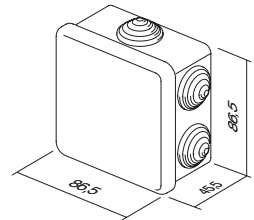

KUTI SHPËRNDARJEJE IP55 NDO1



- AF20PW
- AF20GY

- kuti lidhjeje me montim në sipërfaqe IP55
- xhuntot përfshihen
- në përputhje me standardet IEC/EN 60670-1, IEC/EN 60670-22

DISTRIBUTION BOX IP55 NDO1

- surface mounting connection box IP55
- glands included
- in accordance with IEC/EN 60670-1, IEC/EN 60670-22

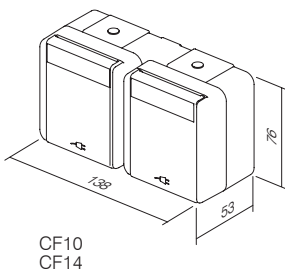
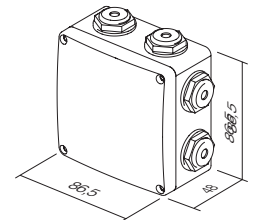

CF10  
CF14

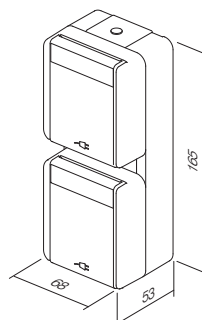

CF11  
CF15

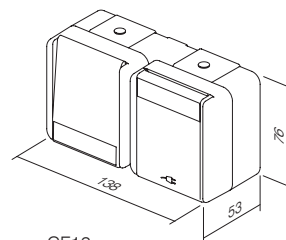

CF12  
CF16

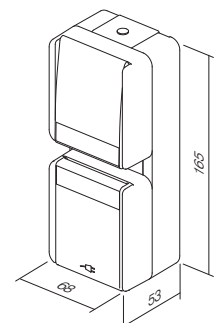

CF13  
CF17

## MODUL

kodi	Përshkrimi i produktit	faqe	kodi	Përshkrimi i produktit	faqe
<b>ÇELËSAT SM</b>			<b>KOMUNIKIMET KM</b>		
SM10	ÇELËS ME 1 DREJTIM 16 AX 250 V- 1M	38	KM10--	PRIZË TV BAZË 0 dB 1M	52
SM11	BUTON ME SHYTPJE ME 1 DREJTIM 16 A 250 V- 1M	38	KM20--	PRIZË TV BAZË 0 dB 2M	52
SM12	ÇELËS ME 1 DREJTIM 20 A 250 V- 1M	38	KM11--	PRIZË TV ME KAPAK FUNDOR 1 dB 1M	52
SM20	ÇELËS 2-POLAR 16 AX 250 V- 1M	38	KM12--	PRIZË TV KALUESE 10 dB 1M	52
SM40	MBYLLËSE ÇELËSI 1-0-2 16 AX 250 V- 1M	39	KM15--	PRIZË SAT BAZË 0 dB 1M	53
SM41	MBYLLËSE BUTONI ME SHYTPJE 1-0-2 16 A 250 V- 1M	39	KM24--	PRIZË SAT BAZË 0 dB 2M	53
SM60	ÇELËS ME 2 DREJTIME 16 AX 250 V- 1M	39	KM16--	PRIZË SAT ME KAPAK FUNDOR 1 dB 1M	53
SM61	BUTON ME SHYTPJE ME 2 DREJTIME 16 A 250 V- 1M	39	KM19--	PRIZË R BAZË 0 dB 1M	53
SM70	ÇELËS NDËRMJETËS 16 AX 250 V- 1M	39	KM29--	PRIZË R BAZË 0 dB 2M	53
SM10--	ÇELËS ME 1 DREJTIM 16 AX 250 V- 1M	40	KM25--	PRIZË SAT-TV ME KAPAK FUNDOR 1 dB 2M	53
SM10--IN	ÇELËS ME 1 DREJTIM 16 AX 250 V- 1M IN	40	KM22--	PRIZË AUDIO 2xRCA 1M	54
SM11--	BUTON ME SHYTPJE ME 1 DREJTIM 16 A 250 V- 1M	40	KM23--	PRIZË AUDIO ALTOPARLANTË 1M	54
SM11--IN01	BUTON ME SHYTPJE ME 1 DREJTIM 16 A 250 V- 1M IN 01	40	KM26--	PRIZË AUDIO ALTOPARLANTË 2M	54
SM11--IN02	BUTON ME SHYTPJE ME 1 DREJTIM 16 A 250 V- 1M IN 02	41	KM30--	PRIZË TEL LT RJ11 6/4 1M	55
SM20--NT03	ÇELËS 2-POLAR 16 AX 250 V- 1M NT 03	41	KM31--	PRIZË TEL BT SEC 6/6 1M	55
SM20--IN	ÇELËS 2-POLAR 16 AX 250 V- 1M IN	41	KM36--	PRIZË TEL KS RJ11 6/4 1M	55
SM40--NT10	MBYLLËSE ÇELËSI 1-0-2 16 AX 250 V- 1M NT 10	41	KM37--	PRIZË CAT5e KS RJ45 8/8 1M	55
SM41--NT10	MBYLLËSE BUTONI ME SHYTPJE 1-0-2 16 A 250 V- 1M __ NT 10	41	KM35--	PËRSHTATËS KS 1M	55
SM60--	ÇELËS ME 2 DREJTIME 16 AX 250 V- 1M	41	KM38--	PËRSHTATËS KS ME MBROJTJE NGA PLUHURI 1M	55
SM61--	BUTON ME SHYTPJE ME 2 DREJTIME 16 A 250 V- 1M	42	KM39--	PRIZË CAT6 SCH KS RJ45 8/8 1M	56
SM62--CD	BUTON ME SHYTPJE ME 2 DREJTIME ME KORDON 16 A 250 V- 1M __ CD	42	KM50--	PËRSHTATËS KS UNIVERSAL 1M	56
SM70--	ÇELËS NDËRMJETËS 16 AX 250 V- 1M	42	KM40--	PËRSHTATËS PD 1M	56
<b>BUTONAT TM</b>			KM43--	PËRSHTATËS PD ME MBROJTJE NGA PLUHURI 1M	56
TM11--	BUTON 1M	43	KM46--	PËRSHTATËS R&M 1M	56
TM11--IN	BUTON 1M IN	43	KM52--	PËRSHTATËS R&M CAT6A 1M	56
TM12--	BUTON 2M	43	KM47--	PËRSHTATËS R&M ME MBROJTJE NGA PLUHURI 1M	57
TM12--IN	BUTON 2M IN	43	KM53--	PËRSHTATËS R&M CAT6A ME MBROJTJE NGA PLUHURI 1M	57
TM13--IL	BUTON 2M ME KAPAK ME MBISHKRIM	44	KM45--	PËRSHTATËS LK 1M	58
TM15--	BUTON 1M 2-POLAR	44	KA26	PËRSHTATËS NEXANS/SCHRACK 2M	58
TM21--	FALSO 1M	44	KM48--	PËRSHTATËS AT&T SYSTMIX ME MBROJTJE NGA PLUHURI 1M	58
TM22--	FALSO 2M	44	KM51--	PRIZË USB LLOJIT A 1M	58
TM31--	DALJE PËR KABLLO 1M	44	<b>AKSESORËT E KOMUNIKIMIT KA</b>		
<b>NDRIÇUESIT IA</b>			KA10	KONEKTOR KS RJ11 RJ11 6/4	59
IA10OR	LLAMBË NEONI 230 V- 0,34 W	46	KA11	KONEKTOR KS CAT5e RJ45 8/8	59
IA20--	LLAMBË LED 230 V AC/DC 0,4 W	46	KA12	KONEKTOR KS CAT5eS RJ45 8/8	59
IA21--	LLAMBË LED 24 V AC/DC 0,2 W	46	KA15	KONEKTOR KS RJ45 SCHRACK RJ45 8/8	59
IA22--	LLAMBË LED 12V AC/DC 0,10 W	46	KA16	KONEKTOR KS RJ45 SCHRACK RJ45 8/8	59
IA50	QARK RC 250 V	46	KA17	KONEKTOR KS CAT6a SCHRACK RJ45 8/8	59
<b>PRIZAT VM</b>			KA18	KONEKTOR KS RJ45 SCHRACK RJ45 8/8	60
VM10--	PRIZË SCHUKO+KS 2P+E 16 A 250 V- 2M	48	KA27	KONEKTOR KS HDMI	60
VM11--	PRIZË SCHUKO+KS+KAPAK 2P+E 16 A 250 V- 2M	48	KA28	KABLLOJA KS HDMI	60
VM20--	PRIZË EVROPIANE+KS 2P 10 A 250 V- 1M	49	<b>LIDHJET ELEKTRONIKE EM</b>		
VM40--	PRIZË FRANCEZE+KS 2P+E 16 A 250 V- 2M	49	EM12--	REOSTAT RROTULLUES/2 DREJTIME RL 300 W 1M	61
VM41--	PRIZË FRANCEZE+KS+KAPAK 2P+E 16 A 250 V- 2M	49	EM13--	REOSTAT RROTULLUES/2 DREJTIME LED 60 W 1M	61
VM30--	PRIZË ITALIANE P17/11+KS 2P+E 16 A 250 V- 1M	49	EM14--	REOSTAT RROTULLUES/2 DREJTIME LED 180 W 1M	62
VM31--	PRIZË SCHUKO/ITALIANE P17/11+KS 2P+E 16 A 250 V- 2M	49	EM15--	REOSTAT RROTULLUES R 250 W 1M	62
VM32--	PRIZË SCHUKO/ITALIANE P30+KS 2P+E 16 A 250 V- 2M	50	EM16--	1-10 V ÇELËSI RROTULLUES ME DY DREJTIME I REOSTATIT	62
VM33--	PRIZË ITALIANE P11+KS 2P+E 10 A 250 V- 1M	50	EM23	REOSTAT ME MONTIM NË KUTI R (250 W), (RC, RL 200VA)	63
VM21--	PRIZË EVROPIANE/AMERIKANE+KS 2P 16 A 250 V- 1M	50	EM18	REOSTAT ME MONTIM NË KUTI LED 250 W	63
VM52--	PRIZË BRITANIKE BS 1363+KS 2P+E 13 A 250 V- 2M	50	EM19	REOSTAT ME MONTIM NË KUTI DC LED 96 W	63
VM55--	PRIZA MULTISTANDARDE+KS 2P+E 13A 250V- 2M	50	EM25--	ÇELËS/REOSTAT UNIVERSAL RLC 0-300 W 2M	65
VM80	MBROJTËS NGA MBITENSIONI MPE MINI 275 V/50 Hz	50	EM26--	NJËSI KONTROLLI ME BUTON ME SHYTPJE 2M	67
			EM27	FILTËR FREKUJENCE	67
			EM25PPOL20	SET ÇELËS/REOSTAT RLC 0-300 W 2M PP OL20	67
			EM31--	ÇELËS IR 5 A 230 V- 1M	68
			EM32--	ÇELËS IR 5 A 230 V- 2M	68
			EM37--	TERMOSTAT BAZË 6 A 230 V ~ 2M	70
			EM38--	TERMOSTATI I NGROHJES 5(2)A 230V- 2M	71
			EM39--	TERMOSTAT NGROHJEJE/FTOHJEJE 3(1,5)A 230V- 2M	71
			NM39	KORNIZË MONTIMI ME VIDA PËR TERMOSTATE FANTINI COSMI 3M	72
			EM40--	ÇELËS KARTE PËR KURSIMI E ENERGJISË 3 A 250 V- 3M	72
			EM47	KARTË ISO	72
			EM44--	ÇELËS KARTE PËR KURSIMI TË ENERGJISË RF HF 13,56 MHz 3M	73
			EM49	NJËSI KONTROLLI E KURSIMIT TË ENERGJISË 2x16 A 250 V-	73
			EM45	SHPËRNDARËS SPL-1	73
			EM60--	PRIZË PËR RROJË 230 V~/120 V- 3M	74
			EM67--	NJËSI USB E FURNIZIMI ME ENERGJI 5 V 2,4 A 1M	74
			EM68--	NJËSI USB E FURNIZIMIT ME ENERGJI 5 V 3,0 A	75
			EM55	DITË EMERGJENCE LED 250 V- 0,90 W, NiCd 3h 7M	75
			EM57	DITË EMERGJENCE 230 V- 50 Hz 0,5 W, NiMH 2h 2M	75
			EM50--	LLAMBË LED NJËNGJYRËSHE 250 V- 0,8 W 2M	76
			EM51--	LLAMBË LED ME DY NGJYRA 250 V- 2 x 0,4 W 2M	76
			EM52--	LLAMBË LED 3D ME DY NGJYRA 250 V- 2 x 0,4 W 2M	76
			EM71--	ÇELËS ME GJURMË GISHTI BIOPASS 2M	77
			EM80--	ÇELËS, PA PREKJE 10 A 240 V-	78
			EM81--	ÇELËS, PA PREKJE	78
			EM91--	SINJALIZUES 8 VA 12 V-1M	79
			EM93--	ZILE 8 VA 12V-1M	79
			EM94--	ZILE 230V- 6mA rms 1M	79
			EM95--	KONTROLL VOLUMI 100 V LINJË AUDIO 35 W 2M	80
			EM96--	KONTROLL VOLUMI 4-8 Ω 35 W 2M	80

kodi	Përshkrimi i produktit	faqe	kodi	Përshkrimi i produktit	faqe
<b>SETI CM</b>			<b>KUTITË E RRUMBULLAKËTA</b>		
CM10--	SET PRIZASH 2x SCHUKO 2P+E 16 A 250 V~ 4M	81	DE10	KUTI E RRUMBULLAKËT PËR TULLË SM60-01	110
CM11--	SET PRIZASH 3x SCHUKO 2P+E 16 A 250 V~ 7M	81	DE11	KUTI E RRUMBULLAKËT PËR TULLË TË THELLË SM60-06	110
CM15	SET LIDHJEJE 3x1,5 mm <sup>2</sup> 1M	82	DE30	KAPËSE E KOMBINUAR SM60-03	110
CM16	SET LIDHJEJE 3x2,5 mm <sup>2</sup> 2M	82	DE31	KAPËSE E KOMBINUAR SM60-04	110
CM17	SET VIDASH 3,5x20	82	DE12	KUTI E RRUMBULLAKËT PËR TULLË 65-46	111
CM18	SET VIDASH 3,5x35	82	DE13	KUTI E RRUMBULLAKËT PËR TULLË 65-60	111
CM19	SET VIDASH 3,5x50	82	DE14	PJESË SHITESË PËR MD 65-46	111
CM22--	SET ÇELËSASH IP44 2M	82	DE32	KAPËSE E KOMBINUAR MD 65-71	111
CM23--	SET PRIZASH IP44 2M	82	DE33	KAPËSE E KOMBINUAR MD 65-91	111
CM25--OL	SET ÇELËSASH PËR BANJË 3x20 A 250 V~ 4M OL	82	DE20	KAPAK MBROJTËS PËR KUTI 60	111
CM25--OS	SET ÇELËSASH PËR BANJË 3x20 A 250 V~ 4M OS	82	DE21	KAPAK MBROJTËS PËR KUTI 65	111
NM41	SET KORNIZË MONTIMI PËR BANJË 4M	83	DE22	KAPAK DEKORATIV PËR KUTI SM60	111
OL41--	SET KAPAKU MBULUES LINE PËR BANJË	83	HE10	KUTI E RRUMBULLAKËT PËR MUR BOSH SM68x40	114
OS41--	SET KAPAKU MBULUES SOFT PËR BANJË	83	HE11	KUTI E RRUMBULLAKËT PËR MUR BOSH SM68x55	114
<b>PROGRAMI ANTIBAKTERIAL AW</b>			BE10	KUTI E RRUMBULLAKËT PËR BETON 60-49	114
TM11AW	BUTON 1M	85	BE11	KUTI E RRUMBULLAKËT PËR BETON 60-77	114
TM11AWIN	BUTON 1M IN	85	BE20	KUNDËR-SUPORT KUTIE PËR BETON	114
TM12AW	BUTON 2M	85	BE21	KUTI PËR BETON PËR BLOKUES TUBI 16	114
TM12AWIN	BUTON 2M IN	85	<b>KUTITË DREJTKËNDORE</b>		
TM21AW	FALSO 1M	85	DM30	KUTI DREJTKËNDORE PËR TULLË PM3	118
TM22AW	FALSO 2M	85	DM31	KUTI DREJTKËNDORE PËR TULLË PM3-65	118
VM10AW	PRIZË SCHUKO+KS 2P+E 16 A 250 V~ 2M	86	DM40	KUTI DREJTKËNDORE PËR TULLË PM4	118
VM11AW	PRIZË SCHUKO+KS+KAPAK 2P+E 16 A 250 V~ 2M	86	DM41	KUTI DREJTKËNDORE PËR TULLË PM4-65	118
VM20AW	PRIZË EVROPIANE+KS 2P 10 A 250 V~ 1M	86	DM70	KUTI DREJTKËNDORE PËR TULLË PM7	119
KM11AW	PRIZË TV ME KAPAK FUNDOR 1 dB 1M	86	DM71	KUTI DREJTKËNDORE PËR TULLË PM7-65	119
KM35AW	PËRSHATËS KS 1M	86	DM72	KUTI DREJTKËNDORE PËR TULLË PM72-65	119
OS20AW	KAPAK MBULUES SOFT 2M	87	DM80	PJESË DISTANCUESE PËR KUTI PM	119
OS24AW	KAPAK MBULUES SOFT 2x2M	87	DM33	KAPAK MBROJTËS PËR KUTI PM3	120
OS26AW	KAPAK MBULUES SOFT 3x2M	87	DM34	KAPAK DEKORATIV PËR KUTI PM3	120
OS30AW	KAPAK MBULUES SOFT 3M	87	DM43	KAPAK MBROJTËS PËR KUTI PM4	120
OS40AW	KAPAK MBULUES SOFT 4M	87	DM44	KAPAK DEKORATIV PËR KUTI PM4	120
OS70AW	KAPAK MBULUES SOFT 7M	87	DM73	KAPAK MBROJTËS PËR KUTI PM7	120
<b>KAPAKËT MBULUES PURE OP</b>			DM74	KAPAK DEKORATIV PËR KUTI PM7	120
OP20--	KAPAK MBULUES PURE 2M	90	DM75	KAPAK DEKORATIV PËR KUTI PM72	121
OP24--	KAPAK MBULUES PURE 2x2M	90	HM30	KUTI DREJTKËNDORE PËR MUR BOSH VM3	122
OP26--	KAPAK MBULUES PURE 3x2M	90	HM40	KUTI DREJTKËNDORE PËR MUR BOSH VM4	122
OP28--	KAPAK MBULUES PURE 4x2M	90	HM70	KUTI DREJTKËNDORE PËR MUR BOSH VM7	122
OP30--	KAPAK MBULUES PURE 3M	91	HM72	KUTI DREJTKËNDORE PËR MUR BOSH VM72	122
OP40--	KAPAK MBULUES PURE 4M	91	BM30	KUTI DREJTKËNDORE PËR BETON BM3	123
OP70--	KAPAK MBULUES PURE 7M	91	BM40	KUTI DREJTKËNDORE PËR BETON BM4	123
OP13--	KAPAK MBULUES PURE 1/3M	91	BM70	KUTI DREJTKËNDORE PËR BETON BM7	123
OP23--	KAPAK MBULUES PURE 2/3M	91	BM80	KAPËSE FIKSUESE E KOMBINUAR BM	123
<b>KAPAKËT MBULUES LINE OL</b>			BM82	PJESË DISTANCUESE PËR KUTI BM	123
OL20--	KAPAK MBULUES LINE 2M	94	<b>KUTITË LIDHËSE</b>		
OL24--	KAPAK MBULUES LINE 2x2M	94	DW10	KUTI E RRUMBULLAKËT TULLË PËR LIDHJE DSM78	126
OL26--	KAPAK MBULUES LINE 3x2M	94	HW10	KUTI E RRUMBULLAKËT MUR BOSH PËR LIDHJE SM78x45	126
OL28--	KAPAK MBULUES LINE 4x2M	94	DE23	KAPAK DEKORATIV PËR KUTI SM78	126
OL29--	KAPAK MBULUES LINE 5x2M	94	DE24	KAPAK MBROJTËS PËR KUTI 78	126
OL30--	KAPAK MBULUES LINE 3M	95	HW20	KUTI KATRORE TULLË PËR LIDHJE SM105x105	126
OL40--	KAPAK MBULUES LINE 4M	95	<b>AKSESORËT E LIDHJEVE</b>		
OL70--	KAPAK MBULUES LINE 7M	95	UW10--	BLOQE TERMINALESH ME 1 RADHË TË MBYLLURA PC 2x2,5 mm <sup>2</sup> 10P	128
OL10--	KAPAK MBULUES LINE 1/2M	95	UW11--	BLOQE TERMINALESH ME 1 RADHË TË MBYLLURA PC 2x4 mm <sup>2</sup> 10P	128
OL13--	KAPAK MBULUES LINE 1/3M	95	UW12--	BLOQE TERMINALESH ME 1 RADHË TË MBYLLURA PC 2x6 mm <sup>2</sup> 10P	128
OL23--	KAPAK MBULUES LINE 2/3M	95	UW15--	BLOQE TERMINALESH ME 1 RADHË PA 2x2,5 mm <sup>2</sup> 12P	128
<b>KAPAKËT MBULUES SOFT OS</b>			UW16--	BLOQE TERMINALESH ME 1 RADHË TË MBYLLURA PA 2x4 mm <sup>2</sup> 12P	128
OS20--	KAPAK MBULUES SOFT 2M	98	UW17--	BLOQE TERMINALESH ME 1 RADHË TË MBYLLURA PA 2x6 mm <sup>2</sup> 12P	128
OS24--	KAPAK MBULUES SOFT 2x2M	98	UW29--	BLOQE TERMINALESH ME 2 RADHË PP 1,0-4,0 mm <sup>2</sup> 12P	128
OS26--	KAPAK MBULUES SOFT 3x2M	98	UW30--	BLOQE TERMINALESH ME 2 RADHË PP 1,5-6,0 mm <sup>2</sup> 12P	128
OS28--	KAPAK MBULUES SOFT 4x2M	98	UW31--	BLOQE TERMINALESH ME 2 RADHË PP 2,5-10 mm <sup>2</sup> 12P	128
OS30--	KAPAK MBULUES SOFT 3M	99	UW32--	BLOQE TERMINALESH ME 2 RADHË PP 4,0-16 mm <sup>2</sup> 12P	128
OS40--	KAPAK MBULUES SOFT 4M	99	UW25--	BLOQE TERMINALESH ME 2 RADHË PA 1,0-4,0 mm <sup>2</sup> 12P	129
OS70--	KAPAK MBULUES SOFT 7M	99	UW26--	BLOQE TERMINALESH ME 2 RADHË PA 1,5-6,0 mm <sup>2</sup> 12P	129
OS72--	KAPAK MBULUES SOFT 2x7M	99	UW27--	BLOQE TERMINALESH ME 2 RADHË 2,5-10 mm <sup>2</sup> 12P	129
OS10--	KAPAK MBULUES 1/2M	99	UW28--	BLOQE TERMINALESH ME 2 RADHË PA 4,0-16 mm <sup>2</sup> 12P	129
OS13--	KAPAK MBULUES SOFT 1/3M	99	UW40--	KONEKTORË PËR FUTJE TELASH PA 1,5 mm <sup>2</sup> 3P	129
OS23--	KAPAK MBULUES SOFT 2/3M	99	UW41--	KONEKTORË PËR FUTJE TELASH PA 1,5 mm <sup>2</sup> 5P	129
<b>KORNIZAT E MONTIMIT NM</b>			UW42--	KONEKTORË PËR FUTJE TELASH PA 1,5 mm <sup>2</sup> 8P	129
NM20	KORNIZË MONTIMI ME KUNJA KAPËSE 2M	104	UW45--	KONEKTORË PËR FUTJE TELASH PA 2,5 mm <sup>2</sup> 3P	129
NM21	KORNIZË MONTIMI PA VIDA 2M	104	UW46--	KONEKTORË PËR FUTJE TELASH PA 2,5 mm <sup>2</sup> 4P	129
NM24	KORNIZË MONTIMI METALIKE ME KUNJA KAPËSE 2M	104	UW47--	KONEKTORË PËR FUTJE TELASH PA 2,5 mm <sup>2</sup> 5P	129
NM25	KORNIZË MONTIMI METALIKE PA VIDA 2M	104	UW50--	KONEKTORË PËR FUTJE TELASH PA 2,5 mm <sup>2</sup> 2/1P	129
NM30	KORNIZË MONTIMI ME VIDA 3M	105			
NM40	KORNIZË MONTIMI ME VIDA 4M	105			
NM70	KORNIZË MONTIMI ME VIDA 7M	105			
NM72	KORNIZË MONTIMI ME VIDA 2x7M	105			
NM10	KORNIZË MONTIMI ME KUNJA KAPËSE 1/2M	106			
NM11	KORNIZË MONTIMI PA VIDA 1/2M	106			
NM23	KORNIZË MONTIMI ME KUNJA KAPËSE 2/3M	106			
NM32	KORNIZË MONTIMI ME VIDA 2/3M	106			

## shpërndarja

## LOGIQ

kodi	Përshkrimi i produktit	faqe
<b>KUTI CUBO IP20 AC</b>		
AC11--	KUTI NO CUBO ME KAPAK TË PASMË ANËSOR IP20 1M	132
AC21--	KUTI NO CUBO ME KAPAK TË PASMË ANËSOR IP20 2M	132
AC41--	KUTI NO CUBO ME KAPAK TË PASMË ANËSOR IP20 4M	132
AC61--	KUTI NO CUBO ME KAPAK TË PASMË ANËSOR IP20 6M	132
<b>KUTI CUBO IP55 AQ</b>		
AQ20--	KUTI NO CUBO IP55 2M	133
AQ22--	KUTI NO CUBO IP55 2x2M	133
AQ30--	KUTI NO CUBO IP55 3M	133
AQ21--	KUTI PO CUBO IP55 2M	134
AQ31--	KUTI PO CUBO IP55 3M	134
<b>SISTEME KANALINASH ALUMINI MA</b>		
RT10	PËRSHTATËS MA 162	135
RT12--	KAPAK MBULUES MA 92 2/3M	135
RT14--	KAPAK MBULUES MA 162 4M	135
RT17--	KAPAK MBULUES MA 162 7M	135
RT20--	BAZË PËR KANALINA MA 130x65	136
RT21--	BAZË PËR KANALINA MA 165x65	136
RT25--	KAPAK I PËRPARMË MA 92	136
RT30	RAFT KABLLOSH MA 43	136
RT31	RAFT KABLLOSH MA 43 AL	136
RT32	RAFT KABLLOSH MA 43 AL DYSH	136
RT35--	ELEMENT FUNDOR BLOKUES MA 130x65	137
RT36--	ELEMENT FUNDOR BLOKUES MA 165x65	137
RT38	SET PËSËSH BASHKUESE MA 65	137
RT40--	KËND UNIVERSAL MA 130x65	137
RT41--	KËND UNIVERSAL MA 165x65	137
RT42	PJESË TOKËZIMI MA 2x A6,3	137
RT43--	RAKORD L MA 130x65	138
RT44--	RAKORD L MA 165x65	138
RT45--	RAKORD T MA 130x65	138
RT46--	RAKORD T MA 165x65	138
RT50--	PLLAKËZ FIKSUESE MA NJËSHE 130x65	139
RT51--	PLLAKËZ FIKSUESE MA DYSHE 130x65	139
RT52--	KABINË SHËRBIMI MA 130x65x500	139
RT53--	KABINË SHËRBIMI MA DYSHE 130x65x500	139
<b>KUTI DYSHEMEJE MT</b>		
RB50	BAZË KUTIE DYSHEMEJE 4M	141
RB60	INSERT PËR KUTI SHPËRNDARJEJE PËR DYSHEME 4M	141
RB65S1	KAPAK PËR KUTI SHPËRNDARJEJE PËR DYSHEME 4M	141
RB51	BAZË KUTIE DYSHEMEJE 7M	141
RB61	INSERT PËR KUTI SHPËRNDARJEJE PËR DYSHEME 7M	141
RB66S1	KAPAK PËR KUTI SHPËRNDARJEJE PËR DYSHEME 7M	141
RB52	BAZË KUTIE DYSHEMEJE 2x7M	142
RB62	INSERT PËR KUTI SHPËRNDARJEJE PËR DYSHEME 2X7M	142
RB67S2	KAPAK PËR KUTI SHPËRNDARJEJE PËR DYSHEME 2X7M	142
RB53	BAZË KUTIE DYSHEMEJE 4x7M	142
RB62	INSERT PËR KUTI SHPËRNDARJEJE PËR DYSHEME 2X7M	142
RB68S2	KAPAK PËR KUTI SHPËRNDARJEJE PËR DYSHEME 4X7M	142
RB55S1	KUTI DYSHEMEJE ME KAPAK PËR DYSHEME DYSHE 4M	143
RB60	INSERT PËR KUTI SHPËRNDARJEJE PËR DYSHEME 4M	143
RB56S1	KUTI DYSHEMEJE ME KAPAK PËR DYSHEME DYSHE 7M	144
RB61	INSERT PËR KUTI SHPËRNDARJEJE PËR DYSHEME 7M	144
RB57S2	KUTI DYSHEMEJE ME KAPAK PËR DYSHEME DYSHE 2X7M	144
RB62	INSERT PËR KUTI SHPËRNDARJEJE PËR DYSHEME 2X7M	144
RB58S2	KUTI DYSHEMEJE ME KAPAK PËR DYSHEME DYSHE 4X7M	144
RB62	INSERT PËR KUTI SHPËRNDARJEJE PËR DYSHEME 2X7M	144
RB10	PËRSHTATËS PËR SHINË DIN 35 mm 1M	145
RB11	PËRSHTATËS PËR SHINË DIN 35 mm 2M	145

kodi	Përshkrimi i produktit	faqe
<b>ÇELËSAT SQ</b>		
SQ10--XO	ÇELËS ME 1 DREJTIM 10 AX 250 V-	158
SQ10--INXO	ÇELËS ME 1 DREJTIM 10 AX 250 V- __ IN	158
SQ11--XO	BUTON ME SHTYPJE ME 1 DREJTIM 10 A 250 V-	158
SQ11--IN01XO	BUTON ME SHTYPJE ME 1 DREJTIM 10 A 250 V- __ IN 01	158
SQ11--IN02XO	BUTON ME SHTYPJE ME 1 DREJTIM 10 A 250 V- __ IN 02	159
SQ22--IN03XO	ÇELËS 2-POLAR 16 AX 250 V- __ IN 03	159
SQ50--XO	ÇELËS ME 2 VENDE - 1 DREJTIM 10 AX 250 V-	159
SQ51--XO	BUTON ME SHTYPJE ME 2 VENDE - 1 DREJTIM 10 A 250 V-	159
SQ52--NT09XO	MBYLLËSE ÇELËSI 10 AX 250 V- __ NT 09	159
SQ53--NT09XO	MBYLLËSE BUTONI ME SHTYPJE 10 A 250 V- __ NT 09	159
SQ60--XO	ÇELËS ME 2 DREJTIME 10 AX 250 V-	159
SQ63--XO	ÇELËS DYSH ME 2 DREJTIME 10 AX 250 V-	160
SQ70--XO	ÇELËS NDËRMJETËS 10 AX 250 V-	160
<b>NDRIÇUESIT IA</b>		
IA10--	LLAMBË NEONI 230 V- 0,34 W	161
IA20--	LLAMBË LED 230 V- AC/DC 0,4 W	161
IA21--	LLAMBË LED 24 V AC/DC 0,2W	161
IA22--	LLAMBË LED 12 V AC/DC 0,1W	161
<b>PRIZAT VQ</b>		
VQ10--XO	PRIZË SCHUKO 2P+E 16 A 250 V- __ XO	164
VQ11--XO	PRIZË SCHUKO+KAPAK 2P+E 16 A 250 V- __ XO	164
VQ12--XO	PRIZË SCHUKO 2P+E 16 A 250 V- BV __ XO	164
VQ13--XO	PRIZË SCHUKO+KAPAK 2P+E 16 A 250 V- BV __ XO	164
VQ16--	PRIZË SCHUKO DYSHE 2P+E 16 A 250 V-	164
<b>KOMUNIKIMET KQ</b>		
KQ10--XO	PRIZË TV BAZË 0 dB	165
KQ11--XO	PRIZË TV-R ME KAPAK FUNDOR 1 dB	165
KQ12--XO	PRIZË TV-R KALUESE 10 dB	165
KQ16--XO	PRIZË SAT-TV-R ME KAPAK FUNDOR 3 dB	165
KQ22--XO	PRIZË AUDIO 2xRCA	166
KQ23--XO	PRIZË AUDIO PËR ALTOPARLANTË	166
KQ36--XO	PRIZË TEL KS RJ11 6/4	166
KQ37--XO	PRIZË CAT5e KS RJ45 8/8	166
KQ38--XO	PRIZË TEL KS DYSHE 2x RJ11 6/4	166
KQ39--XO	PRIZË CAT5e KS DYSHE 2x RJ45 8/8	166
KQ35--XO	PRIZË TEL LT RJ11 6/4	166
KQ40--XO	PRIZË CAT6s KS DYSHE 2x RJ45 8/8 E HOLLË	167
KQ41--XO	PRIZË CAT6s KS DYSHE 2x RJ45 8/8 E HOLLË	167
<b>LIDHJET ELEKTRONIKE EQ</b>		
EQ15--XO	REOSTAT RROTULLUES ME 2 DREJTIME RL 400 W	168
EQ16--XO	REOSTAT RROTULLUES ME 2 DREJTIME RLC 400 W	168
EQ19--XO	REOSTAT RROTULLUES ME 2 DREJTIME LED 100 W	168
EQ32--XO	ÇELËS IR 5 A 230 V-	170
EQ35--XO	TERMOSTAT PËR NGROHJE 10 A 230 V-	170
EQ36--XO	TERMOSTAT PËR NGROHJE/FTOHJE 5 A 230V-	170
EQ37--XO	NGROHJE ME TERMOSTAT NGA DYSHEMEJA 16 A 230 V-	171
EQ68--	NJËSI USB E FURNIZIMIT ME ENERGI 5 V 3,0 A	171
<b>KAPAKËT PQ</b>		
PQ10--XO	TAPË	172
PQ30--	KAPAK TAE/TDO	172
<b>RRETHUESE OQ</b>		
OQ10--	KAPAK MBULUES LOGIQ 1	173
OQ20--	KAPAK MBULUES LOGIQ 2	173
OQ30--	KAPAK MBULUES LOGIQ 3	174
OQ40--	KAPAK MBULUES LOGIQ 4	174
OQ50--	KAPAK MBULUES LOGIQ 5	174



## ekonomik

kodi	Përshkrimi i produktit	faqe
<b>ÇELËSAT SE</b>		
SE10	ÇELËS ME 1 DREJTIM 10 AX 250 V-	186
SE11	BUTON ME SHYTPJE ME 1 DREJTIM 10 A 250 V-	186
SE22	ÇELËS 2-POLAR 16 AX 250 V-	186
SE50	ÇELËS ME 2 VENDE - 1 DREJTIM 10 AX 250 V-	186
SE51	BUTON ME SHYTPJE ME 2 VENDE - 1 DREJTIM 10 A 250 V-	187
SE52	MBYLLËSE ÇELËSI 10 AX 250 V-	187
SE53	MBYLLËSE BUTONI ME SHYTPJE 10 A 250 V-	187
SE60	ÇELËS ME 2 DREJTIME 10 AX 250 V-	187
SE63	ÇELËS DYSH ME 2 DREJTIME 10 AX 250 V-	187
SE70	ÇELËS NDËRMJETËS 10 AX 250 V-	187
SE10--	ÇELËS ME 1 DREJTIM 10 AX 250 V-	188
SE10--IN	ÇELËS ME 1 DREJTIM 10 AX 250 V- IN	188
SE11--	BUTON ME SHYTPJE ME 1 DREJTIM 10 A 250 V-	188
SE11--TI50	BUTON ME SHYTPJE ME 1 DREJTIM 10 A 250 V- TI 50	188
SE11--TI51	BUTON ME SHYTPJE ME 1 DREJTIM 10 A 250 V- TI 51	188
SE11--IL	BUTON ME SHYTPJE ME 1 DREJTIM 10 A 250 V- IL	188
SE22--IN03	ÇELËS 2-POLAR 16 AX 250 V- IN 03	188
SE50--	ÇELËS ME 2 VENDE - 1 DREJTIM 10 AX 250 V-	189
SE51--	BUTON ME SHYTPJE ME 2 VENDE - 1 DREJTIM 10 A 250 V-	189
SE52--NT09	MBYLLËSE ÇELËSI 10 AX 250 V- NT 09	189
SE53--NT09	MBYLLËSE BUTONI ME SHYTPJE 10 A 250 V- NT 09	189
SE60--	ÇELËS ME 2 DREJTIME 10 AX 250 V-	189
SE63--	ÇELËS DYSH ME 2 DREJTIME 10 AX 250 V-	189
SE70--	ÇELËS NDËRMJETËS 10 AX 250 V-	189
<b>BUTONAT TE</b>		
TE10--	BUTON ME 1 VEND	190
TE10--IN	TREGUES BUTONI	190
TE13--IL	BUTON ME KAPAK ME MBISHKRIM IL	190
TE11--	BUTON ME 2 VENDE	190
<b>NDRIÇUESIT IA</b>		
IA10--	LLAMBË NEONI 230 V~ 0,34 W	191
IA20--	LLAMBË LED 230 V~ AC/DC 0,4 W	191
IA21--	LLAMBË LED 24 V AC/DC 0,2W	191
IA22--	LLAMBË LED 12 V AC/DC 0,1W	191
<b>PRIZAT VE</b>		
VE10--XO	PRIZË SCHUKO 2P+E 16 A 250 V- XO	194
VE11--XO	PRIZË SCHUKO+KAPAK 2P+E 16 A 250 V- XO	194
VE12--XO	PRIZË SCHUKO 2P+E 16 A 250 V- BV XO	194
VE13--XO	PRIZË SCHUKO+POKROV 2P+E 16 A 250 V- BV XO	194
VE10--	PRIZË SCHUKO 2P+E 16 A 250 V-	194
VE11--	PRIZË SCHUKO+KAPAK 2P+E 16 A 250 V-	194
VE12--	PRIZË SCHUKO 2P+E 16 A 250 V- BV	194
VE13--	PRIZË SCHUKO+KAPAK 2P+E 16 A 250 V- BV	194
VE40--XO	PRIZË FRANCEZE 2P+E 16 A 250 V- XO	195
VE41--XO	PRIZË FRANCEZE+KAPAK 2P+E 16 A 250 V- XO	195
VE42--XO	PRIZË FRANCEZE 2P+E 16 A 250 V- BV XO	195
VE43--XO	PRIZË FRANCEZE+KAPAK 2P+E 16 A 250 V- BV XO	195
VE40--	PRIZË FRANCEZE 2P+E 16 A 250 V-	195
VE41--	PRIZË FRANCEZE+KAPAK 2P+E 16 A 250 V-	195
VE42--	PRIZË FRANCEZE 2P+E 16 A 250 V- BV	195
VE43--	PRIZË FRANCEZE+KAPAK 2P+E 16 A 250 V- BV	195
VE16--	PRIZË SCHUKO DYSHE 2P+E 16 A 250 V-	196
VE46--	PRIZË FRANCEZE DYSHE 2P+E 16 A 250 V-	196
VE30--	PRIZË 2P 16 A 250 V-	196
<b>KOMUNIKIMET KE</b>		
KE11	PRIZË TV-R ME KAPAK FUNDOR 1 dB	197
KE12	PRIZË TV-R KALUESE 10 dB	197
KE16	PRIZË SAT-TV-R ME KAPAK FUNDOR 3 dB	197
KE36	PRIZË TEL KS RJ11 6/4	197
KE37	PRIZË CAT5e KS RJ45 8/8	198
KE40	PRIZË CAT6s KS RJ45 8/8 E HOLLË	198
KE38	PRIZË TEL KS DYSHE 2x RJ11 6/4	198
KE39	PRIZË CAT5e KS DYSHE 2x RJ45 8/8	198
KE41	PRIZË CAT6s KS DYSHE 2x RJ45 8/8 E HOLLË	198
KE45	PËRSHTATËS KS NJËSH	198
KE46	PËRSHTATËS KS DYSH	199
KE47	PËRSHTATËS PD DYSH	199
KE10--	PRIZË TV BAZË 0 dB	200
KE11--	PRIZË TV-R ME KAPAK FUNDOR 1 dB	200
KE12--	PRIZË TV-R KALUESE 10 dB	200
KE16--	PRIZË SAT-TV-R ME KAPAK FUNDOR 3 dB	200
KE22--	PRIZË AUDIO 2xRCA	200
KE23--	PRIZË AUDIO PËR ALTOPARLANTË	200
KE36--	PRIZË TEL KS RJ11 6/4	200
KE37--	PRIZË CAT5e KS RJ45 8/8	201
KE40--	PRIZË CAT6s KS RJ45 8/8 E HOLLË	201
KE38--	PRIZË TEL KS DYSHE 2x RJ11 6/4	201
KE39--	PRIZË CAT5e KS DYSHE 2x RJ45 8/8	201
KE41--	PRIZË CAT6s KS DYSHE 2x RJ45 8/8 E HOLLË	201
KE35--	PRIZË TEL LT RJ11 6/4	201

kodi	Përshkrimi i produktit	faqe
<b>KAPAKËT PE</b>		
PE10--	KAPAK TV-R 2P/3P	202
PE20--	KAPAK KS NJËSH	202
PE21--	KAPAK KS DYSH	202
PE30--	KAPAK TAE/TDO	202
<b>LIDHJET ELEKTRONIKE EE</b>		
EE15	REOSTAT RROTULLUES ME 2 DREJTIME RL 400 W	203
EE16	REOSTAT RROTULLUES ME 2 DREJTIME RLC 400 W	203
EE19	REOSTAT RROTULLUES ME 2 DREJTIME LED 100 W	204
EE32	ÇELËS IR 5 A 230 V-	204
EE67	NJËSI USB E FURNIZIMIT ME ENERGJI 5 V 2,4 A	204
EE15--	REOSTAT RROTULLUES ME 2 DREJTIME RL 400 W	205
EE16--	REOSTAT RROTULLUES ME 2 DREJTIME RLC 400 W	205
EE19--	REOSTAT RROTULLUES ME 2 DREJTIME LED 100 W	205
EE32--	ÇELËS IR 5 A 230 V-	205
EE67--	NJËSI USB E FURNIZIMIT ME ENERGJI 5 V 2,4 A	206
<b>KAPAK ELEKTRONIK PE</b>		
PE41--	REOSTAT ME KAPAK Ø6	208
PE32--	ÇELËS IR ME KAPAK	208
PE67--	KAPAK PËR NJËSINË USB TË FURNIZIMIT ME ENERGJI	208
<b>AKSESORËT AE</b>		
AE10--	TAPË	209
AE20--	KUTI LIDHJEJE 5-POLARE 3P+N+E 5x4mm2	209
AE30--	KUTI ME MONTIM NË SIPËRFAQE 1	209
AE31--	KUTI ME MONTIM NË SIPËRFAQE PËR PRIZË DYSHE EKONOMIK	209
AE50--	MBROJTJE PËR MURIN	210
AE51--	MBROJTJE PËR FËMIJËT KS	210
<b>RRETHUESE OE</b>		
OE10--	RRETHUES EKONOMIK 1	211
OE20--	RRETHUES EKONOMIK 2 HORIZONTAL	211
OE21--	RRETHUES EKONOMIK 2 VERTIKAL	211
OE30--	RRETHUES EKONOMIK 3 HORIZONTAL	211
OE31--	RRETHUES EKONOMIK 3 VERTIKAL	212
OE40--	RRETHUES EKONOMIK 4 HORIZONTAL	212
OE41--	RRETHUES EKONOMIK 4 VERTIKAL	212
OE50--	RRETHUES EKONOMIK 5 HORIZONTAL	212
OE90--	KORNIZA DEKORATIVE ME NGJYRA	213

## fontana

kodi	Përshkrimi i produktit	faqe
<b>ÇELËSAT SF</b>		
SF10--	ÇELËS ME 1 DREJTIM IP44 10 AX 250 V-	216
SF10--TI	ÇELËS ME 1 DREJTIM IP44 10 AX 250 V- TI	216
SF11--TI	BUTON ME SHYTPJE ME 1 DREJTIM IP44 10 A 250 V- TI	216
SF20--	ÇELËS 2-POLAR IP44 10 AX 250 V-	216
SF50--	ÇELËS ME 2 VENDE ME 1 DREJTIM IP44 10 AX 250 V-	217
SF51--	BUTON ME SHYTPJE ME 2 VENDE ME 1 DREJTIM IP44 10 A 250 V-	217
SF60--	ÇELËS ME 2 DREJTIME IP44 10 AX 250 V-	217
SF60--TI	ÇELËS ME 2 DREJTIME IP44 10 AX 250 V- TI	217
SF63--	ÇELËS DYSH ME 2 DREJTIME 10 AX 250 V-	217
SF70--	ÇELËS NDËRMJETËS IP44 10 AX 250 V-	217
<b>PRIZAT VF</b>		
VF10--	PRIZË SCHUKO+KAPAK IP44 2P+E 16 A 250 V-	218
VF12--	PRIZË SCHUKO+KAPAK IP44 2P+E 16 A 250 V- BV	218
<b>SETET CF</b>		
CF10--	SET PRIZASH SCHUKO DYSHE HORIZONTALE IP44 2x2P+E 16 A 250 V-	219
CF11--	SET PRIZASH SCHUKO DYSHE VERTIKALE IP44 2x2P+E 16 A 250 V-	219
CF12--	PRIZË SCH+SET ÇELËSASH ME 2 DREJTIME HORIZONTALE IP44 16 A + 10 AX 250 V-	219
CF13--	PRIZË SCH+SET ÇELËSASH ME 2 DREJTIME VERTIKALE IP44 16 A + 10 AX 250 V-	220
CF14--	SET PRIZASH SCHUKO DYSHE HORIZONTALE IP44 2x 2P+E 16 A 250 V-BV	220
CF15--	SET PRIZASH SCHUKO DYSHE VERTIKALE IP44 2x 2P+E 16 A 250 V- BV	220
CF16--	PRIZË SCH+SET ÇELËSASH ME 2 DREJTIME HORIZONTALE IP44 16 A + 10 AX 250 V- BV	220
CF17--	PRIZË SCH+SET ÇELËS ME 2 DREJTIME VERTIKALE IP44 16 A + 10 AX 250 V- BV	220
<b>AKSESORËT AF</b>		
AF10--	KUTI SHPËRNDARJEJE IP44 RN01	221
AF20--	KUTI SHPËRNDARJEJE IP55 ND01	221



**TEM**

On | Off and everything in between

100% ELEKTRIČEN

[www.tem.si](http://www.tem.si)



**TEM**

On|Off and everything in between



[www](http://www.tem.si)



**TEM**

TEM ČATEŽ d.o.o.  
Čatež 13, 8212 VELIKA LOKA  
SLOVENIJA  
tem@tem.si  
www.tem.si

T +386(0)7 348 99 00

**TEM**

AL

[www.tem.si](http://www.tem.si)

